

MASSACHUSETTS WATER RESOURCES AUTHORITY

WASTEWATER SYSTEM MASTER PLAN



SEPTEMBER 2013

2013 MWRA Wastewater System Master Plan

Table of Contents

MWRA MASTER PLAN EXECUTIVE SUMMARY

Chapter 1: INTRODUCTION

1.01	Overview of MWRA	1-1
1.02	Purpose of the Wastewater System Master Plan	1-1
1.03	Planning Approach and Time Frame	1-2
1.04	Organization of the Master Plan	1-2
1.05	Periodic Updates	1-3
1.06	MWRA Business Plan	1-3
1.07	Sources of Information	1-3
1.08	Master Plan Priority Ratings for Wastewater System Projects	1-8

Chapter 2: MISSION, GOALS AND OBJECTIVES

2.01	MWRA Mission	2-1
2.02	Wastewater Goals and Objectives	2-1

Chapter 3: HISTORY AND BACKGROUND

3.01	Chapter Summary	3-1
3.02	History of Wastewater Collection and Treatment	3-1
3.03	Growth of the Sewer Service Area	3-2
3.04	Transition from MDC to MWRA	3-4
3.05	Overview of the MWRA Regional Sewer System	3-5
3.06	MWRA Sewer Expansion Policies	3-6
3.07	Wastewater System Infrastructure Replacement Assets Value	3-7
3.08	Outline of MWRA's Management Structure	3-8
3.09	Time Line of MWRA Wastewater System Accomplishments	3-9

Chapter 4: WASTEWATER REGULATORY FRAMEWORK

4.01	Chapter Summary	4-1
4.02	NPDES Permitting and Reporting for the DITP and MWRA's CSO Facilities and Outfalls	4-1
4.03	NPDES Permitting and Reporting for the Clinton Advanced Wastewater Treatment Plant	4-2
4.04	NPDES Stormwater Permitting and Reporting for MWRA Wastewater Facilities	4-3
4.05	NPDES Permitting and Reporting for Discharges from the Carroll Water Treatment Plant and for Hydroelectric Generating Facilities at Cosgrove and Oakdale	4-3
4.06	NPDES Permitting and Reporting for Pesticide Application at Wachusett Reservoir	4-4
4.07	Current and Long-Term Regulatory Issues and Potential Impacts on MWRA	4-4
4.08	Potential Long-Term Regulatory Considerations	4-6

4.09	Interfacing With Regulators - MWRA's Environmental Quality Department	4-7
Chapter 5:	WASTEWATER FLOW AND QUALITY TO THE DEER ISLAND TREATMENT PLANT	
5.01	Chapter Summary	5-1
5.02	MWRA Sewer Service Area to DITP	5-2
5.03	NPDES Permit for DITP	5-4
5.04	Review of Wastewater Flow to DITP	5-4
5.05	Potential Future Increase in Sanitary Flow to DITP	5-9
5.06	Potential for Future Wastewater Flow Increases to Impact DITP	5-14
5.07	Review of Wastewater Quality to DITP	5-15
Chapter 6:	DEER ISLAND TREATMENT PLANT	
6.01	Chapter Summary	6-1
6.02	Facilities Overview	6-6
6.03	Management and Staffing	6-9
6.04	Operation and Maintenance of Deer Island	6-12
6.05	Pumping and Preliminary Treatment	6-14
6.06	Primary Wastewater Treatment	6-21
6.07	Secondary Wastewater Treatment	6-24
6.08	Disinfection and Dechlorination	6-29
6.09	Outfall Tunnel and Effluent Discharge	6-31
6.10	Residuals Processing	6-33
6.11	Electrical Generation and Distribution	6-40
6.12	Odor Control Facilities	6-50
6.13	Additional Support Systems	6-52
6.14	Summary of Existing and Recommended Capital Projects	6-59
Chapter 7:	RESIDUALS PROCESSING AND DISPOSAL (OFF-ISLAND) AT THE PELLETT PLANT	
7.01	Chapter Summary	7-1
7.02	Residuals Pellet Plant Overview	7-3
7.03	Pellet Plant Contract Operations, Maintenance, and Ongoing Upgrades	7-4
7.04	MWRA Planning for Residuals Management	7-4
7.05	Details on Residual Pellet Plant Operations	7-5
7.06	Fore River Railroad	7-8
7.07	Summary of Existing and Recommended Capital Projects	7-8
Chapter 8:	COLLECTION SYSTEM REMOTE HEADWORKS AND CROSS-HARBOR TUNNELS	
8.01	Chapter Summary	8-1
8.02	Facilities Overview	8-4
8.03	Chelsea Creek Headworks	8-8
8.04	Columbus Park Headworks	8-11
8.05	Ward Street Headworks	8-13
8.06	Nut Island Headworks	8-15
8.07	Intermediate Pump Station	8-18

8.07	Intermediate Pump Station	8-18
8.08	Winthrop Terminal Headworks	8-18
8.09	Remote Headworks Long-term Reinvestment Needs Based on Estimated Replacement Asset Value	8-18
8.10	Boston Main Drainage Tunnel	8-19
8.11	North Metropolitan Relief Tunnel	8-21
8.12	Inter-Island Tunnel	8-21
8.13	Braintree-Weymouth Tunnel	8-22
8.14	Summary of Existing and Recommended Capital Projects	8-23

Chapter 9: COLLECTION SYSTEM SEWERS

9.01	Chapter Summary	9-1
9.02	Overview of the Collection System	9-6
9.03	Gravity Sewers	9-13
9.04	Gravity Sewer Interceptor Renewal and Asset Protection Methodology	9-20
9.05	Sewer System Capacity and Optimization Projects	9-27
9.06	Gravity Sewer Manholes and Related Structures	9-29
9.07	Siphons and Siphon Headhouse Structures	9-30
9.08	Force Mains and Related Valves	9-34
9.09	CSO and Nut Island Emergency Outfalls	9-36
9.10	SCADA and Wastewater Metering System	9-37
9.11	Summary of Existing and Recommended Capital Projects	9-37

Chapter 10: COLLECTION SYSTEM PUMP STATIONS AND CSO FACILITIES

10.01	Chapter Summary	10-1
10.02	Facilities Overview	10-4
10.03	Alewife Brook Pump Station	10-12
10.04	BOS019 CSO Storage Conduit	10-14
10.05	Braintree/Weymouth Replacement Pump Station	10-16
10.06	Caruso Pump Station	10-17
10.07	Chelsea Screen House	10-19
10.08	Cottage Farm Pumped CSO Facility	10-20
10.09	DeLauri Pump Station	10-22
10.10	Framingham Pump Station	10-25
10.11	Hayes Pump Station	10-27
10.12	Hingham Pump Station	10-28
10.13	Hough's Neck Pump Station	10-30
10.14	Intermediate Pump Station (IPS)	10-31
10.15	New Neponset Valley Sewer Pump Station	10-32
10.16	North Dorchester Bay CSO Storage and Pump Facilities	10-34
10.17	Prison Point Pump Station and Pumped CSO Facility	10-36
10.18	Quincy Pump Station	10-39
10.19	Somerville Marginal Gravity CSO Facility	10-40
10.20	Squantum Pump Station	10-42
10.21	Union Park CSO Facility	10-43
10.22	Wiggins – Castle Island Terminal Pump Station	10-44
10.23	Braintree Howard Street Pump Station	10-46
10.24	Decommissioned Facilities and Historical Structures	10-47
10.25	Reinvestment Needs Based on Estimated Replacement Asset Value	10-48
10.26	Summary of Existing and Recommended Capital Projects	10-49

Chapter 11: COMBINED SEWER OVERFLOW CONTROL PLAN

11.01	Chapter Summary	11-1
11.02	Overview of Combined Sewer Overflow Control Plan	11-2
11.03	Completed CSO Control Plan Projects	11-7
11.04	Ongoing CSO Control Plan Projects	11-19
11.05	Future Staffing and Operation and Maintenance Cost Impacts From the CSO Control Plan	11-27
11.06	Future Capital Improvement Project Needs for the CSO Control Plan	11-27
11.07	Summary of Existing CSO Control Plan Capital Projects	11-28

Chapter 12: SUPERVISORY CONTROL AND DATA ACQUISITION (SCADA) AND WASTEWATER METERING SYSTEM

12.01	Chapter Summary	12-1
12.02	SCADA System Overview	12-2
12.03	Wastewater Central Monitoring/SCADA Implementation Projects	12-3
12.04	Wastewater Metering System	12-3
12.05	Summary of Existing and Recommended Capital Projects	12-6

Chapter 13: ENERGY MANAGEMENT, INFORMATION MANAGEMENT, LABORATORY SERVICES, AND SECURITY

13.01	Chapter Summary	13-1
13.02	Energy Management	13-1
13.03	Information Management	13-9
13.04	Laboratory Services	13-13
13.05	Security	13-16

Chapter 14: CLINTON ADVANCED WASTEWATER TREATMENT PLANT

14.01	Chapter Summary	14-1
14.02	Clinton Wastewater Service History	14-2
14.03	Facilities Overview	14-4
14.04	MWRA and Local Collection Systems	14-7
14.05	Wastewater Flow and Quality to Clinton AWWTP	14-7
14.06	Clinton NPDES Permit	14-9
14.07	Clinton AWWTP Process Operations	14-10
14.08	Summary of Existing and Recommended Capital Projects	14-14

Chapter 15: MWRA FINANCIAL ASSISTANCE FOR COMMUNITY-OWNED COLLECTION SYSTEMS

15.01	Chapter Summary	15-1
15.02	Infiltration/Inflow Impact on the Regional Collection System	15-2
15.03	MWRA Regional I/I Reduction Plan	15-5
15.04	MWRA I/I Local Financial Assistance Program	15-6
15.05	Summary of Existing and Recommended Capital Projects	15-9

Chapter 16: RUTLAND-HOLDEN SEWERS

16.01	Chapter Summary	16-1
16.02	History of the Rutland-Holden Sewers	16-1
16.03	MWRA's Role in the Rutland-Holden Sewers	16-2
16.04	Overview of the Rutland-Holden Sewers	16-2
16.05	Flow Allocation, Sewer Billing, Operation, and Maintenance	16-3
16.06	Past Special Projects	16-6
16.07	Summary of Existing and Recommended Capital Projects	16-8

2013 MWRA Water and Wastewater Master Plan - Executive Summary

OVERVIEW

Since its inception, MWRA has expended \$7.7 billion on capital initiatives (FY86 through FY13). Of this spending, 73 percent has supported wastewater system improvements, 25 percent water system improvements, and two percent for business and operations support. The 2013 Master Plan documents the investment needs of MWRA's regional water and wastewater systems over the next 40 years (FY14-53) through the identification of 367 prioritized projects estimated at \$4.0 billion in 2013 dollars. All projects are either already programmed in the FY14 Capital Improvement Program (CIP) (total of \$2.0 billion) or are recommended for consideration in future CIPs (total of \$2.0 billion). Development of the Master Plan is a collaborative process involving MWRA's Planning, Operations, Engineering, and Finance staff. The 2013 Master Plan is a comprehensive update of the 2006 Master Plan.

The Master Plan is an important tool for annual capital planning and budgeting and its spending recommendations have been incorporated in MWRA's multi-year financial planning estimates. The draft 2013 Master Plan was used as a reference to help guide development of the CIP spending cap for FY14-18. The final 2013 Master Plan has been updated to be consistent with the final FY14 CIP budget and is intended to be a companion document to facilitate staff and Advisory Board recommendations and allow for comparison of future investment needs between different parts of the water and wastewater systems. The Master Plan provides information on water and wastewater system facilities and operations at a level of detail to provide the reader the context to understand recommended future capital spending. The 2013 Master Plan lists both projects programmed in the CIP and projects recommended for future consideration during the 40-year planning period. The focus is on projects proposed to require capital spending during the next two 5-year CIP cap cycles, FY14-18 and FY19-23. Following these two 5-year periods, potential capital needs during additional 10-year (FY24-33) and 20-year (FY34-53) planning periods are projected. Estimates of project costs and schedules over the shorter term are expected to be more reliable than out-year estimates. The Master Plan is a key reference document that will be updated every five years to reflect changing water and wastewater system needs, updated asset conditions, evolving regulatory requirements, revised priorities identified through new studies, and other appropriate considerations.

The MWRA Master Plan has two volumes, one detailing water system needs and the second detailing wastewater system needs. This comprehensive Executive Summary covers both volumes and summarizes overall costs. The Water System Master Plan includes major chapters on treatment, the transmission system, and the metropolitan system. The Wastewater System Master Plan includes distinct chapters for major facilities (e.g., Deer Island Treatment Plant, Residuals Pellet Plant, remote headworks, sewers, pump stations, etc.). Chapters include project recommendations to address the issues and needs identified during the planning process. Both Water and Wastewater Plans also provide related background information including system goals and objectives, history of the system, and the assumptions which provide the context for master planning, including: regulatory framework, future population estimates, water demand and quality, wastewater flow and quality, residuals volumes, etc.

In June 2013, the Board of Directors set the FY14-18 5-year CIP spending cap at \$791.7 million. The FY14-18 CIP cap is \$348.0 million (31 percent) less than the \$1,139.2 million average of the prior two five-year CIP cap periods. Staff expect the Board will continue to establish CIP spending caps for future 5-year periods (FY19-23 and beyond) as part of future CIP process discussions. Total Master Plan water and wastewater needs identified for FY14-18 are approximately \$720 million, including \$675 million in projects currently programmed in the CIP and \$45 million in new projects recommended for consideration in future CIPs. Total water and wastewater needs identified for FY19-23 are approximately \$1,218 million, including \$1,039 million in projects currently programmed in the CIP and \$179 million in new projects recommended for consideration in future CIPs. MWRA's estimated water and wastewater reinvestment needs for the 40 year planning period are presented in Table 1 and also displayed graphically in Figures 1, 2, and 3.

All wastewater and water project costs recommended in the Master Plan are summarized by chapter in Attachments A and B. Projects representing about \$3.0 billion are rehabilitation or replacement of existing infrastructure assets at end of their useful life.

The vulnerability assessments undertaken in response to the events of September 11, 2001; along with redundancy and security upgrades, current and anticipated regulatory requirements, water quality, and energy management considerations help shape the Master Plan. Some of the major themes include:

- For the Water System
 - Redundancy for transmission, distribution, and storage;
 - Water pipeline rehabilitation;
 - Increased funding for asset protection needs; and,
 - Continued financial assistance to support member community projects.

- For the Wastewater System
 - Continued asset protection needs at Deer Island;
 - Timing of residuals facilities replacement needs and co-digestion pilot;
 - Timing of remote headworks design/construction upgrades;
 - Timing of interceptor renewal/asset protection projects;
 - Ramping down of CSO Control Plan expenditures and planning for CSO control performance assessment; and,
 - Continued financial assistance to support member community projects.

Issues being debated nationally that could impact MWRA, such as more stringent federal and state regulation, a higher level of CSO control, storm surge/climate change, and pharmaceuticals in wastewater, are identified in the Master Plan, but there are no project-specific recommendations or significant costs included.

**TABLE 1
2013 MWRA MASTER PLAN PROJECT COST SUMMARY (\$ in millions)**

Asset	FY14-18	FY19-23	FY24-33	FY34-53	SUBTOTAL FY14-53
Water Treatment and Land Acquisition Programmed in FY14 CIP	\$31,101	\$79	\$0	\$0	\$31,180
Future Recommended - Water Treatment and Land Acquisition	\$0	\$12,500	\$29,000	\$47,000	\$88,500
Transmission System and Dams Programmed in FY14 CIP	\$74,135	\$233,502	\$118,738	\$0	\$426,375
Future Recommended - Transmission System and Dams	\$0	\$6,100	\$31,725	\$54,000	\$91,825
Metropolitan System, Lab, SCADA, Metering, Energy and Info Management Programmed in FY14 CIP	\$200,676	\$304,887	\$99,674	\$9,906	\$615,143
Future Recommended - Metropolitan System, Lab, SCADA, Metering, Energy and Info Management	\$5,370	\$20,830	\$118,700	\$80,000	\$224,900
SUBTOTAL - Water Projects Programmed in FY14 CIP	\$305,912	\$538,468	\$218,412	\$9,906	\$1,072,698
SUBTOTAL - Future Recommended - Water Projects	\$5,370	\$39,430	\$179,425	\$181,000	\$405,225
TOTAL WATER PROJECTS	\$311,282	\$577,898	\$397,837	\$190,906	\$1,477,923
Wastewater Treatment and Residuals Programmed in FY14 CIP	\$200,687	\$323,510	\$50,428	\$0	\$574,625
Future Recommended - Wastewater Treatment and Residuals	\$29,345	\$22,800	\$211,750	\$535,000	\$798,895
Headworks, Tunnels, Pump Stations, CSO Facilities and CSO Control Plan Programmed in FY14 CIP	\$137,943	\$122,176	\$63	\$0	\$260,182
Future Recommended - Headworks, Tunnels, Pump Stations, CSO Facilities and CSO Control Plan	\$3,000	\$86,500	\$81,000	\$228,000	\$398,500
Sewers, SCADA, Metering and Community Financial Assistance Programmed in FY14 CIP	\$30,480	\$54,521	\$23,817	\$0	\$108,818
Future Recommended - Sewers, SCADA, Metering and Community Financial Assistance	\$7,400	\$30,240	\$174,000	\$181,240	\$392,880
SUBTOTAL - Wastewater Projects Programmed in FY14 CIP	\$369,110	\$500,207	\$74,308	\$0	\$943,625
SUBTOTAL - Future Recommended - Wastewater Projects	\$39,745	\$139,540	\$466,750	\$944,240	\$1,590,275
TOTAL WASTEWATER PROJECTS	\$408,855	\$639,747	\$541,058	\$944,240	\$2,533,900
Total Projects Programmed in FY14 CIP	\$675,022	\$1,038,675	\$292,720	\$9,906	\$2,016,323
Total Future Recommended Projects	\$45,115	\$178,970	\$646,175	\$1,125,240	\$1,995,500
TOTAL PROJECTS	\$720,137	\$1,217,645	\$938,895	\$1,135,146	\$4,011,823

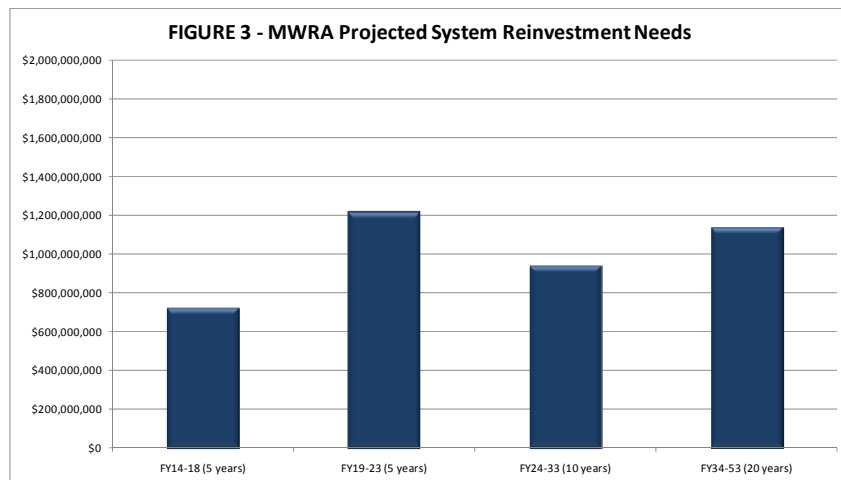
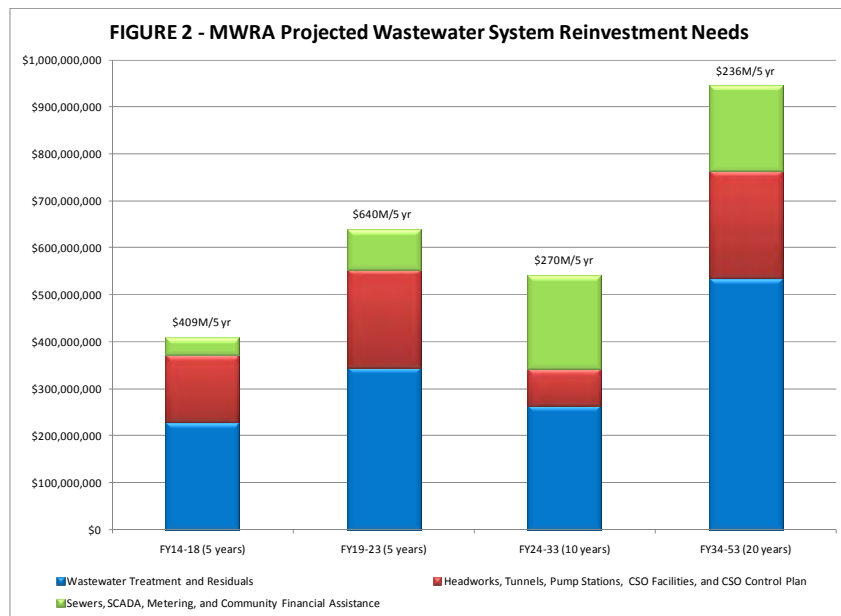
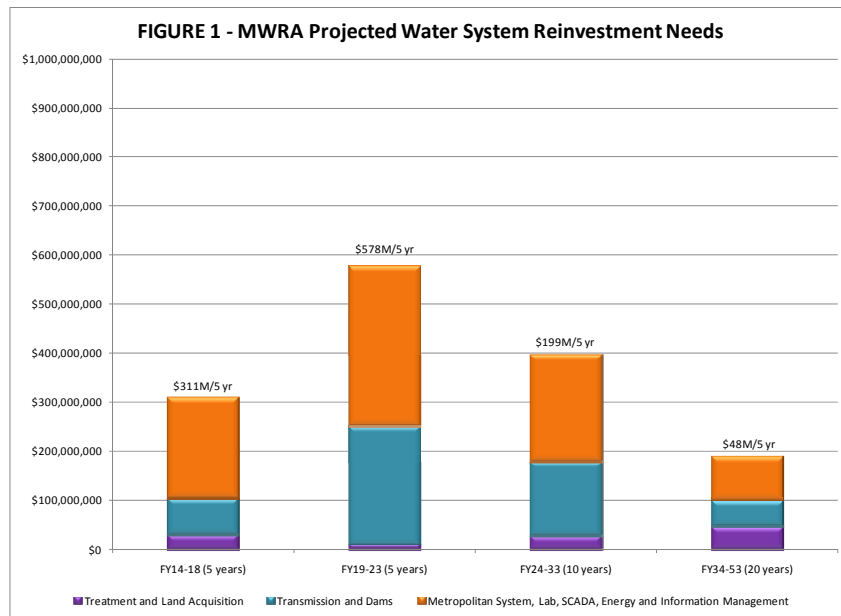

All Master Plan projects have been prioritized on a scale from 1 to 5, as follows: 1 – critical; 2 – essential; 3 – necessary, 4 – important, and 5 – desirable. Highest priority projects will resolve critical threats to public health and prevent imminent system failure resulting in significant service loss. High priority projects will improve system reliability and maintain effluent/residuals quality. Lower priority projects will optimize system performance, assure future capacity, and provide more efficient operation. Project ratings were assigned by MWRA senior managers in concert with Operations, Engineering, and Planning staff. Project priority is reviewed during the annual CIP development process.

The MIS Five Year Information Technology Strategic Plan (IT Plan) addressing MWRA's technological and system needs was completed in 2012. The IT Plan recommendations have now been incorporated into the FY14 CIP and are focused on four major areas of improvement: Application Improvement Programs; Information Security Program; Information Technology Management Programs; and, Information Technology Infrastructure Programs. Each of these focus areas is further broken into specific subprograms. Overall, the FY14 CIP contains approximately \$20.9 million dollars to support these efforts with approximately \$19.3 scheduled to be spent within the FY14-18 time period. The major areas of focus are: replacing aging systems and the network architecture, improving disaster recovery, enhancing data integration, consolidating server/computing resources, and implementing applicable best practices as part of software vendor solutions. The goal is to continue to support efficient administrative, financial, operational, engineering and planning functions with cost-effective technology. To the extent that some of these improvements are more directly focused on water and wastewater operations, they are discussed in both Master Plan documents. However, although costs are noted, they are not carried in the Water and Wastewater System Master Plan. Please refer to the IT Plan for more detailed information.

SUMMARY OF THE 2013 WATER SYSTEM MASTER PLAN

MWRA's water system includes its source reservoirs, treatment facilities, transmission lines, and distribution system facilities and pipelines; the system (excluding the source reservoirs) has an estimated replacement asset value of approximately \$6.5 billion. There has been significant investment in MWRA's water system. The earlier \$1.7 billion Integrated Water Supply Improvement Program which included watershed protection, construction of new water treatment, transmission and storage facilities, and relining or replacing of MWRA and community water pipes began to address deferred maintenance. SCADA technology has been adopted throughout the system, a rehabilitation program to complete the upgrading of pump stations is complete, and MWRA has rehabilitated miles of its distribution system pipeline and constructed new pipeline where redundancy or other system needs have been identified. Subsequent work is adding UV disinfection to the two treatment facilities; addressing remaining system redundancy needs and incorporating asset protection funding into annual planning.

Notwithstanding MWRA's success in carrying out this comprehensive infrastructure improvement effort, there remain system infrastructure challenges to be addressed. Total water system needs identified for the FY14-53 Master Plan timeframe are approximately \$1.5 billion (in current dollars), including all projects currently in the CIP and those recommended for consideration in future CIPs. Approximately 56 percent of the total water system need addresses remaining system redundancy costs and approximately 37 percent is programmed for the rehabilitation or replacement of existing infrastructure assets at end of their useful life. The

remaining 7 percent includes completion of the UV disinfection processes, energy management projects, watershed land acquisition and optimization of other water system assets.

Table 2 shows the breakdown by planning period.

TABLE 2 - 2013 Water System Master Plan Cost Summary

	FY14-18	FY19-23	FY24-33	FY34-53	Total Cost (\$1000)
Projects Programmed in the FY14 CIP	305,912	538,468	218,412	9,906	1,072,698
Projects Recommended for Future CIPs	5,370	39,430	179,425	181,000	405,225
Total	311,282	577,898	397,837	190,906	1,477,923

The water system needs assessment is based on the following major assumptions and findings:

- The 300 mgd safe yield of the MWRA water system is sufficient to meet future demand for water both within the service area and additional demand outside the service area.
- Modeling efforts indicate climate change is not expected to have significant impacts on reservoir yield, in fact, safe yield may increase slightly. Changes in climate may encourage surrounding communities to turn to MWRA for portions of their supply as droughts become more frequent or severe.
- No design and construction funds are included to address the impacts on the MWRA water system of potential changes in federal or state regulations.
- Water supply redundancy and new storage projects provide operational flexibility and enhance system security. Planning for redundancy for key elements of both the transmission and distribution systems was a focus of the 2006 Water System Master Plan. Specific projects to address these needs are now programmed in the CIP with major milestones completed by 2025 and the remaining implementation ongoing through FY37 (final phase of Southern Extra High work) and a total remaining cost of approximately \$831 million. This includes design and construction of projects to address redundancy for the southern part of the service area served by the Metropolitan tunnel system and the rehabilitation/replacement of WASM 3 which will address redundancy for the northern part of the Metropolitan tunnel system.
- Master Plan recommendations include inspections of the Cosgrove Tunnel as well as the Metropolitan Tunnel System (Quabbin Tunnel Inspection is in the FY14 CIP and is scheduled to begin in FY19). The Master Plan proposes a placeholder value of \$65 million for design and rehabilitation of the Metropolitan Tunnels. This is intended to address access, tunnel inspection and initial valve replacement needs; however, if inspections of any of the tunnels were to indicate more significant problems, costs could be much higher.

- The Master Plan again emphasizes the need to continue systematically lining the remaining MWRA-owned older unlined cast-iron mains (approximately 58 miles) to address potential water quality degradation concerns and related health risks in light of MWRA customer expectations and EPA's anticipated direction for distribution system regulation, and to continue to replace/rehabilitate more than 21 additional miles of steel pipes prone to corrosion and susceptible to leaks. Metropolitan system pipeline expenditures identified in the CIP or recommended in the Master Plan are approximately \$271 million (excludes WASM 3 pipe miles and costs).
- The Master Plan recommends a pipeline study in FY20 to help MWRA assess the ongoing need for rehabilitation beyond the above work. The study will look at the any pipe remaining to be rehabilitated (mostly constructed since 1950), expected replacement cycles for lined pipes and assess information on corrosion and other factors.
- The Master Plan recommends continuing to systematically address the long-term need to protect and eventually replace other water system assets, including equipment, valves, pump stations, storage facilities, treatment and transmission system buildings and equipment (not including tunnels or piping), dams, and support systems, \$272 million, FY14-53.
- Financial assistance to support member community water system rehabilitation projects to help maintain high quality water is planned to continue but must be evaluated against competing MWRA CIP needs. Even with the substantial progress made over the last 15 years via MWRA's community water loans, about 2,100 miles (33 percent) of community-owned water mains remain unlined. The Master Plan recommends two additional water loan program phases FY21-40 (each at \$210 million in loans over 10 years) to extend the current program approved through FY20. Since there is no grant component to water financial assistance, the impact to MWRA's CIP is minor compared to the sewer grant/loan program.

For the water system, this Master Plan varies somewhat significantly from the previous Master Plan. During that planning effort, the focus was on major shortcomings in overall system redundancy and the need to identify and move projects forward to address this issue. The CIP now incorporates much of this work. Master Plan findings and recommendations for water priority projects during the FY14-23 timeframe are summarized below. The Master Plan identifies \$889 million in water system needs during this period (excluding community financial assistance). Of this \$889 million, \$844 million is in the existing CIP and \$49 million is recommended for inclusion in future CIPs.

The Board of Directors has set a spending cap of \$791.7 million for the FY14-18 time period. Work to establish the cap incorporated information from this Master Plan. All projects have been prioritized on a scale from 1 to 5, with 1 being projects considered critical and 5 considered desirable. Highest priority projects will resolve critical threats to public health and prevent imminent system failure resulting in significant service loss. High priority projects will fix existing reliability problems related to single points of failure, address facilities in poor condition where the ability to provide uninterrupted service or adequate flow is compromised, and meet basic hydraulic performance requirements, including adequate distribution storage. Lower priority projects will maintain infrastructure integrity and maintain efforts to manage system demands. Project ratings were assigned by MWRA senior managers in concert with Planning

and Coordination Department staff. All MWRA projects (water, sewer, and business support) will be further prioritized during the CIP planning cycles.

The Transmission System – Tunnels and Aqueducts, Facilities, and Dams

MWRA's water transmission system consists of over 100 miles of tunnels and aqueducts in daily use which transport water by gravity from the supply reservoirs to points of distribution within the service area. The basic layout of the system as designed is fundamentally sound. System improvements over time have allowed for older facilities, no longer in daily use, to remain as critical emergency standby facilities as long as maintained and linked to new facilities where necessary. The performance standards for a major transmission system are: ability to transport sufficient water to meet the maximum daily demands of the service area, and reliability in that there must be sufficient redundant components to ensure a continued supply of water system if any one "leg" of the system were to fail. MWRA's transmission system ably meets system demands and much of the system has redundant components that may be brought on line.

However, as noted in the 2006 Master Plan and discussed in this plan, shortfalls in redundancy remain. This work has been added to the CIP since the last Master Plan. The critical project was to complete the Water Transmission Redundancy Plan (WTRP) which identified the major failure scenarios for the Metropolitan tunnel system and identified potential levels of service. This iterative process allowed MWRA to develop a range of alternatives to address these redundancy shortfalls. Preliminary projects to address redundancy of the Cosgrove Tunnel, the City Tunnel, the City Tunnel Extension and the Dorchester Tunnel were developed. The Wachusett Aqueduct Pump Station was determined to be the best alternative to address Cosgrove Tunnel redundancy and that project is currently in design. For the Metropolitan tunnel system, work is now ongoing to refine the concepts developed for the northern and southern portions of the Metropolitan system and move forward with environmental review and move into the design phases for each project.

The Master Plan process has also considered the needs of the many facilities that are part of the transmission system. Again, many projects have been added to the CIP since the completion of the 2006 Master Plan. This includes improvements to halt any ongoing deterioration and ensure safe and secure facility operations at some facilities and at other locations, more extensive modifications are proposed or underway to increase operational flexibility and to modernize equipment and systems.

MWRA, under its 2004 Memorandum of Agreement with the Department of Conservation and Recreation (DCR), is responsible for water supply dams, with a couple of exceptions. MWRA previously paid DCR Division of Watershed Management to perform capital improvements for these dams. Based on fall 2005 inspections, much work has been completed. Long-term, continued periodic maintenance of both the earthen and the masonry dams will be necessary.

In the near-term (through FY23), the Master Plan identifies approximately \$313 million in transmission system project needs including projects currently in the FY14 CIP and new work proposed.

Treatment Plants

The FY14 CIP shows approximately \$25 million to be spent for water treatment related costs and facility modifications during the FY14-18 time frame. This includes the remaining costs of completing the addition of UV disinfection at both the CWTP and at the Quabbin WTP. And it includes a new asset protection program at the CWTP for \$500,000. The Master Plan recommends that an additional \$53.5 million be allocated to asset protection for these facilities during the FY19-53 time period.

The Metropolitan System

The Metropolitan System consists of approximately 284 miles of distribution pipeline east of Shaft 5, eleven storage tanks, eleven pump stations, nine tunnel shafts, and approximately 4700 valves. The system is divided into 7 pressure zones.

As noted earlier, MWRA is proceeding to address important distribution system pipeline redundancy problems areas in the Northern Intermediate High (NIH), Southern Extra High (SEH), and the WASM 3 service areas and, more generally, in service areas with single spine mains. The NIH and SEH also have shortfalls in storage. An additional 20 mg of storage is also under construction for the Northern Low service area (Spot Pond Covered Storage). Significant redundancy and rehabilitation work was added to the CIP as a result of the previous Master Plan. The CIP currently contains almost \$600 million in Metropolitan System projects in the FY14-53 timeframe with much of it prior to FY24. This includes the replacement/rehabilitation of WASM 3 which also provides redundancy to the City Tunnel and City Tunnel Extension as currently conceived. The distribution system network has approximately 79 remaining miles of unlined cast-iron pipe, posing water quality concerns, and 39 miles of steel pipe not yet rehabilitated which is prone to corrosion and susceptible to leaks; both are recommended for continued focus over the long-term, as are valve replacements. Some of this work is within the existing CIP and a number of pipelines are also addressed in the Master Plan. The Master Plan also recommends continued funding for pump station asset replacement as well as for asset replacement for covered storage facilities at appropriate intervals. SCADA components and continued water meter system upgrades need to be addressed cyclically as well.

Land Acquisition

The FY14 CIP includes a total of \$6 million to enable DCR to acquire parcels of, or interests in, real estate critical to protection of the watershed and source water quality. The Master Plan recommends an ongoing program of approximately \$1 million per year through the FY19-53 planning horizon for an additional \$35 million or a total of \$41 million.

Community Financial Assistance – Local Water System Assistance Program

Even with the substantial progress made over the last 15 years, MWRA estimates that over 2,100 miles of community water main remain unlined, representing a future community water main replacement/rehabilitation cost of over \$1.0 billion. For master planning purposes, staff recommend future third and fourth phases of the Local Water System Assistance Program be considered for funding in future CIPs. Each new phase is recommended to provide \$210 million in interest-free loans (with 10-year loan repayments) during the FY21-30 and FY31-40

timeframes. MWRA staff will continue to work cooperatively with the Advisory Board to identify potential program improvements which may be recommended to the Board for approval.

SUMMARY OF THE 2013 WASTEWATER SYSTEM MASTER PLAN

MWRA's wastewater system is a complex network of conduits and facilities receiving flow from 43 member sewer communities covering an area of about 518 square miles. The regional system serves approximately 2.2 million people, including the City of Boston and surrounding metropolitan area. The Deer Island Treatment Plant (DITP) receives an average daily flow of 360 mgd and has a peak wet weather capacity of 1,270 mgd, with additional system capacity available at combined sewer overflow (CSO) outfalls. Residuals from DITP are processed into pellets for beneficial reuse at MWRA's sludge-to-fertilizer plant in Quincy. The MWRA collection system includes four remote headworks facilities, a network of 274 miles of sewer pipelines and cross-harbor tunnels, 13 pump stations, one screening facility, and six CSO treatment/storage facilities. MWRA also operates the Clinton Advanced Wastewater Treatment Plant (AWWTP) providing sewage treatment services to the Town of Clinton and the Lancaster Sewer District. MWRA's goal is to operate and maintain these facilities to provide uninterrupted wastewater collection and treatment service in a safe, cost-effective, and environmentally sound manner.

MWRA's wastewater infrastructure has an estimated replacement value of over \$6.6 billion. The scale and scope of MWRA's wastewater system operation – encompassing collections, pumping, CSO, treatment, effluent discharge, and beneficial reuse of residuals – presents challenges in maintenance, rehabilitation, and replacement. Deer Island alone has 70,000 equipment and instrumentation components. Regular maintenance and replacement cycles have become standard plant operating practice, but will become increasingly costly as the plant ages. Capital projects across the system will be implemented while facilities are on-line, posing operational challenges, and project staffing considerations will also need to be weighed. Finally, all system spending is against the backdrop of rates management.

Total wastewater needs identified for the FY14-53 Master Plan timeframe are over \$2.53 billion (in current dollars), including \$0.94 billion already programmed in the FY14 CIP and \$1.59 billion recommended for consideration in future CIPs. Over 94 percent, \$2.40 billion of the \$2.53 billion needs estimate for all wastewater projects, are rehabilitation or replacement of existing infrastructure assets at end of their useful life. The remaining \$130 million in needs are for CSO Control Plan projects, treatment or interceptor projects to optimize the existing system or add capacity, wastewater modeling, new equipment that supports automated facility operation, technology upgrades, and studies/condition assessments.

The needs assessment is based on the following major assumptions and findings:

- No new communities are expected to join the wastewater system. Future population and employment growth in the service area is projected to be modest. Wastewater flow is not expected to increase and wastewater quality parameters are not projected to change.
- Storm surge together with anticipated sea level rise resulting from the changing climate will affect a number of MWRA coastal wastewater facilities. The Master Plan assumes any

significant flood mitigation efforts will be undertaken as each facility is rehabilitated or upgraded, and that simpler measures will be implemented as maintenance efforts.

- No significant design and construction funds are included for potential long-term regulatory changes that may impact MWRA, beyond those items anticipated (\$15 million for phosphorus removal and technology upgrades at Clinton) based on current NPDES permit discussions and the 2013 revised draft Clinton permit. Future regulatory issues that may have cost implications for MWRA include: more stringent limits on nutrients, conventional pollutants, or emerging contaminants; more stringent focus on reduction or elimination of sanitary sewer overflows (SSOs), expansion of MWRA's role in local stormwater permitting; a higher level of CSO control; or more stringent biosolids reuse criteria.
- Significant asset protection needs at Deer Island will continue (estimated at over \$450 million for the next 10 years) and the residuals pellet plant facility will require large-scale equipment replacement (included in the FY14 CIP at \$100 million over the next 10 years). MWRA is in development of a long-term residuals plan and will begin piloting co-digestion in FY14. Modest funds (\$250,000) are currently included in the CIP for co-digestion upgrades. Based on the outcome of the pilot project, additional capital expenditures may be recommended to implement co-digestion long-term. Additional co-digestion funds are not yet included in the CIP or Master Plan, but a portion may be covered within the existing residuals equipment replacement budget.
- The cross-harbor tunnels are assumed to be in good condition. A \$5 million tunnel inspection, condition assessment, and shaft repair project is programmed in the current CIP during FY19-23. The condition of the cross-harbor tunnels and potential need for future investment is a significant unknown for MWRA until the inspection/condition assessment project is complete. Included as a Master Plan recommendation is a \$50 million placeholder for future inspection/cleaning/repair of the tunnels in the out years of the planning period (FY46-50).
- Older headworks facilities require significant reinvestment that is programmed in the CIP (estimated at \$162 million over the next 10 years). Upgrade projects at headworks and facilities across the system will be implemented while systems remain on-line, posing operational challenges.
- MWRA's 20 pump stations and CSO facilities, while generally in good condition, are aging and some are in need of rehabilitation or upgrade. The Master Plan reinvestment strategy for these facilities estimates a \$117 million need over the next 10 years, only 25 percent of which is currently programmed in the FY14 CIP.
- No additional CSO capital costs are included (other than maintenance of existing facilities) beyond the planned \$49.4 million (FY14-24) to complete the remaining four of 35 projects in the CSO Control Plan and the 3-year CSO control performance assessment. If regulatory action were to mandate a higher level of CSO control, additional capital needs beyond those recommended in the Master Plan would be required.
- The average age of MWRA's 226 miles of gravity sewers is about 65 years old, with about 30 percent over 100 years old. Overall, the collection system is in reasonably good

condition, given its age. MWRA's interceptor renewal program targets the approximate 18 miles (8 percent of gravity sewers) that have significant physical defects. The sections requiring repair are prioritized based on risk and consequence of failure and are regularly monitored through internal TV inspection. In addition to the gravity sewers and structures, MWRA also maintains 29 miles of force mains, siphons, and CSO/emergency outfalls. The Master Plan reinvestment strategy for all sewer pipelines estimates a \$101 million need over the next 10 years, of which 75 percent is currently programmed in the FY14 CIP.

- Wastewater metering and supervisory control and data acquisition (SCADA) systems will continue to require upgrades based on assumed useful life/obsolescence of the electronic equipment. Much of this equipment is expected to require replacement every 10 to 20 years (estimated at over \$14 million for the next 10 years).
- Financial assistance to support member community projects for sewer system rehabilitation and infiltration/inflow reduction is planned to continue but must be evaluated against competing MWRA CIP needs. The Master Plan carries recommended funds for additional community financial assistance, but not beginning until FY19. Accelerating the addition of I/I Local Financial Assistance Program funding is planned to be discussed during the FY15 CIP development process.

The 2013 Master Plan lists programmed and recommended projects with CIP spending in FY14-53 and focuses on projects proposed to require capital spending during the next two 5-year CIP cap cycles: FY14-18 and FY 19-23. Following these two five year periods, potential capital needs during additional 10-year (FY24-33) and 20-year (FY34-53) planning periods are identified. Wastewater System Master Plan project costs for these planning periods are presented in Table 3, below.

TABLE 3 - 2013 Wastewater System Master Plan Cost Summary

	FY14-18	FY19-23	FY24-33	FY34-53	Total Cost (\$1000)
Projects Programmed in the FY14 CIP	369,110	500,207	74,308	0	943,625
Projects Recommended for Future CIPs	39,745	139,540	466,750	944,240	1,590,275
Total	408,855	639,747	541,058	944,240	2,533,900

Wastewater System Master Plan projects during the FY14-18 and FY19-23 timeframes are summarized below under five major headings: (1) Wastewater Treatment - Deer Island and Clinton Plants; (2) Residuals Processing (off-island) at the Pellet Plant, (3) Wastewater Headworks and Cross-Harbor Tunnels, (4) Wastewater Pump Stations, CSO Facilities, and CSO Control Plan, (5) Collection System Sewers, SCADA, Metering, and Community Financial Assistance.

Wastewater Treatment - Deer Island and Clinton Plants, FY14-18 and FY19-23

MWRA's Deer Island Treatment Plant (DITP) is the centerpiece of MWRA's \$3.8 billion construction program to alleviate pollution in Boston Harbor. The plant provides primary and secondary treatment of wastewater collected from approximately 2.2 million people in 43 greater Boston communities. Treated wastewater effluent is carried by a 9.4-mile, 24-foot diameter outfall tunnel and discharged into the 100-foot deep waters of Massachusetts Bay. DITP is designed to process a maximum of 1.27 billion gallons per day and components include: influent pumps, primary treatment, secondary treatment, disinfection, dechlorination, the outfall tunnel, sludge digesters, odor control, and on-site power generation.

The Deer Island Treatment Plant is the second largest plant in the country in terms of maximum daily capacity. Its multiple treatment processes, high level of automation, and its uniquely-constructed technical and engineering systems present challenges to operating, maintaining, and replacing the plant's equipment, structures, and related support systems. Components of DITP came on-line sequentially beginning in January 1995 with construction completed in 2001. Most plant equipment and structures are up to fifteen years old and in good condition. The Wastewater System Master Plan identifies \$215 million in DITP project needs for the FY14-18 timeframe, \$188 million programmed in the FY14 CIP and \$27 million recommended for consideration in future CIPs. For the FY19-23 timeframe, the Master Plan identifies \$237 million in DITP project needs, \$221 million programmed in the FY14 CIP and \$16 million recommended for consideration in future CIPs. Some major DITP projects during FY14-23 include: pump variable frequency drive replacement, clarifier scum skimmer and rehabilitation phase 2, centrifuge replacement, sludge digester and storage tank rehabilitation, continued electrical equipment upgrades (phase 5), switchgear replacement phase 2, HVAC equipment replacement, fire alarm system replacement, and as-needed design.

The Clinton Advanced Wastewater Treatment Plant (AWWTP) provides advanced sewage treatment services to the Town of Clinton and the Lancaster Sewer District. MWRA upgraded the treatment plant and sludge landfill in 1992 at a cost of \$37 million. The plant provides secondary treatment using an activated sludge process in combination with advanced nutrient removal and dechlorination. Effluent is discharged into the South Branch of the Nashua River. The Clinton AWWTP is 20 years old and in generally good condition. Some equipment rehabilitation and replacement projects are recommended; however, significant reinvestment is not required in the short-term. The Master Plan identifies \$12 million in project needs for the Clinton Plant for the FY14-18 timeframe, \$11 million programmed in the FY14 CIP and \$1 million recommended for consideration in future CIPs. Approximately half the FY14-18 budget is allocated to construct new phosphorous removal facilities in anticipation of more stringent phosphorous limits in the draft NPDES permit. The remaining funding is rehabilitation or replacement of equipment. For the FY19-23 timeframe, \$4 million is programmed in the CIP and \$7 million recommended for consideration in future CIPs for both equipment replacement and technology upgrades to meet future regulatory requirements.

Residuals Processing (off-island) at the Pellet Plant, FY14-18 and FY19-23

Digested sludge is pumped from DITP through two 14-inch, seven mile long force mains that are embedded in concrete within the 11-foot diameter Inter-Island Tunnel and connect to the Residuals Pellet Plant in Quincy. The Pellet Plant was built in 1991 and expanded in 2001 to

handle sludge production from DITP secondary treatment facilities. The Residuals Pellet Plant is designed to handle up to 180 dry tons per day of residuals with four of the six operational trains running (current production is 100 to 110 dry tons per day). Pellets are distributed for beneficial reuse. The Pellet Plant is operated and maintained under a long-term contract (March 2001 through December 2015) with a private firm, the New England Fertilizer Company (NEFCo). The annual operating cost is \$14 to \$16 million per year. Since NEFCo is responsible for all operation, maintenance, and capital improvements for the term of the contract, MWRA has not incurred additional major expenditure at the facility.

In 2015, Pellet Plant equipment will be an average of 20 years old. In July 2010, a comprehensive Residuals Facility Condition Assessment and Utility Reliability project was completed. This project reviewed the adequacy of existing facility components and processes and generally found the facility to be in good to very good condition. In FY13-14, MWRA is conducting an assessment of long-term technology options for residuals processing and disposal beyond 2015. MWRA is also piloting co-digestion to evaluate the impacts of adding food waste, oils, and grease to the digesters at DITP to determine if sludge characteristics are affected. Significant reinvestment is anticipated for residuals processing and disposal during the next 10 years.

The Wastewater System Master Plan identifies \$3 million in Residuals Pellet Plant project needs for the FY14-18 timeframe, \$2 million programmed in the FY14 CIP and \$1 million recommended for consideration in future CIPs. For the FY19-23 timeframe, the Master Plan identifies \$98 million in Residuals Pellet Plant facilities upgrade design and construction needs, all of which is programmed in the FY14 CIP.

Wastewater Remote Headworks and Cross-Harbor Tunnels, FY14-18 and FY19-23

MWRA's four remote headworks (Chelsea Creek, Columbus Park, Ward Street, and Nut Island) and 19 miles of cross-harbor tunnels are critical facilities because almost all flow to DITP passes through them. The primary function of the remote headworks is to remove grit and screen out debris from wastewater flow to minimize solids accumulation in the cross-harbor tunnels and protect downstream pump facilities at the DITP. The cross-harbor tunnels (North Metropolitan Relief Tunnel, Boston Main Drainage Tunnel, Inter-Island Tunnel, and Braintree-Weymouth Tunnel) transport wastewater from the remote headworks to Deer Island. The Wastewater System Master Plan identifies \$62 million for FY14-18 and \$121 million for FY19-23 in remote headworks and cross-harbor tunnel project needs, almost all of which is programmed in the FY14 CIP.

The Chelsea Creek, Columbus Park, and Ward Street Headworks were all built in 1967 and are over 45 years old. Equipment at the headworks was upgraded by MWRA in 1987 and is over 25 years old. These three older facilities remain operational, but, largely due to age and equipment obsolescence, are in only fair condition and need significant reinvestment. A Headworks Condition Assessment/Concept Design project was completed in FY10. This project reviewed the adequacy of existing headworks components and processes and provided replacement/upgrade recommendations based upon current technology. MWRA has developed a prioritized design/construction schedule over the next 10-year period at a cost of over \$162 million to rehabilitate the three older remote headworks. Design of upgrades for the Chelsea Creek Headworks began in FY10 and construction is scheduled to run through FY19. The

second phase of the project will be to design and construct upgrades for both Columbus Park and Ward Street Headworks together, during FY16-22. The newer Nut Island Headworks, built in 1998, is in very good condition. A group of smaller scale replacement/upgrade projects are planned for the Nut Island Headworks during the short-term (\$13 million cost), including work on the mechanical, electrical, grit/screenings, and odor control systems, as well as a study of settlement at the fire pump building.

The North Metropolitan Relief Tunnel and Boston Main Drainage Tunnel were built in 1953 and are 60 years old. The Inter-Island Tunnel (1996) and Braintree-Weymouth Tunnel (2005) are relatively new. Based on the industry benchmark of 100+ years for useful life for tunnels, it is assumed that the older cross-harbor tunnels are still in good condition. However, the existing condition of the tunnels is unknown; therefore, there is uncertainty associated with the potential for future repair/rehabilitation and risk of a very large future cost. Some deterioration of concrete in the tunnel shafts has been documented and attributed to hydrogen sulfide corrosion. Since the cross-harbor tunnels and shafts are critical facilities, a study of the effluent shafts, as well as a tunnel inspection and shaft repair project are a high priority. These projects are programmed in the FY14 CIP at \$5 million during FY19-21.

Wastewater Pump Stations, CSO Facilities, and CSO Control Plan, FY14-18 and FY19-23

The MWRA collection system includes 13 pump stations, one screening facility, and six CSO treatment/storage facilities. The primary function of a pump station is to lift wastewater from an upstream sewer (at a lower elevation) to a downstream interceptor (at a higher elevation) so the wastewater can continue to flow by gravity to MWRA headworks facilities. Most pump stations operate continuously; however, two MWRA pump stations (Framingham and New Neponset Valley Sewer Pump Stations) are designed to operate during peak flows (wet weather) only. The primary function of a combined sewer overflow (CSO) facility is to store and/or treat combined (sanitary and stormwater) flow that exceeds the capacity of the combined sewer system in large rainfall events.

The average age of MWRA's 20 collection system facilities is 21 years. Only five of the 20 facilities are more than 25 years old. The oldest pump station, Alewife Brook in Somerville, is 61 years old. Two of MWRA's CSO facilities are 41 years old: the Cottage Farm Pumped CSO Facility and the Somerville Marginal Gravity CSO Facility. Overall, the 20 collection system facilities are in good condition. Significant automation upgrades were implemented under MWRA's Wastewater Central Monitoring/SCADA Implementation Project during 2007-2009. The CSO facilities have undergone upgrades under the CSO Control Plan and two of the former CSO stations (Commercial Point and Fox Point) were decommissioned in 2008 following completion of local sewer separation projects. The highest priority immediate needs for wastewater pump stations and CSO facilities are rehabilitation/replacement projects being implemented at the 10 older facilities.

For wastewater pump stations and CSO facilities, the Wastewater System Master Plan identifies \$31 million in project needs for the FY14-18 timeframe, \$28 million programmed in the FY14 CIP and \$3 million recommended for consideration in future CIPs. For the FY19-23 timeframe, the Master Plan identifies \$86 million in wastewater pump stations and CSO facilities needs, none of which has been programmed in the FY14 CIP. Some major projects during FY14-23 include: ongoing rehabilitation construction at the Alewife Brook Pump Station; a condition

assessment for the 10 oldest wastewater facilities; and follow-up design and construction of upgrades at the oldest stations (Alewife Brook, Caruso, Chelsea Screen House, DeLauri, Hayes, Hingham, Prison Point, Wiggins - Castle Island Terminal, Cottage Farm, and Somerville Marginal).

MWRA's Long-Term CSO Control Plan, as mandated by the Federal Court, is comprised of 35 wastewater system improvement projects that address 84 CSO outfalls. As of July 2013, MWRA and its CSO communities had completed 31 of the 35 projects in the CSO long-term control plan, two projects were well into construction, and the remaining two projects were in design with construction starts scheduled in September 2013 and August 2014. The Federal Court schedule requires MWRA to commence a 3-year performance assessment in January 2018 (approximately two years after the last of the 35 CSO projects is scheduled to be complete) and submit a report assessing attainment of the long-term levels of control by December 2020. The Master Plan includes details on project engineering and construction requirements, schedules, long-term levels of CSO control, status of work to implement the plan, benefits achieved to date, and future activities. The total cost of the CSO Control Plan (including both previous and future expenditures) is \$888 million, of which \$839 million (94 percent) was expended through FY13. The FY14 CIP includes \$49 million in spending during FY14-24 to complete the remaining four of 35 projects in the CSO Control Plan and the 3-year CSO control performance assessment. There are no future MWRA or community-managed CSO Control Plan projects recommended for consideration in future CIPs. Funds to replace equipment at CSO facilities are included in collections system facilities costs.

Collection System Sewers, SCADA, Metering, and Community Financial Assistance. FY14-18 and FY19-23

The primary function of the collection system is to transport wastewater received from the 43 member sewer communities (through over 1,800 community connections) to the MWRA headworks facilities. Collection system operations are intended to optimize system performance and minimize potential CSOs and SSOs, particularly before and during storm events that stress the system's hydraulic capacity. The collection system includes a network of 274 miles of sewer pipelines - 19 miles of cross-harbor tunnels, 226 miles of gravity sewers, 18 miles of force mains, 7 miles of siphons, 4 miles of CSO and emergency outfalls, and 4,000 manholes and other structures. Internal inspection information (physical, television, and sonar) is used to develop maintenance schedules, identify structural problems, and help define rehabilitation projects.

For collection system sewers, supervisory control and data acquisition (SCADA) systems, wastewater metering, and community financial assistance, the Wastewater System Master Plan identifies \$38 million in project needs for the FY14-18 timeframe; \$31 million programmed in the FY14 CIP and \$7 million recommended for consideration in future CIPs. For the FY19-23 timeframe, the Master Plan identifies \$85 million in collection system needs, \$55 million programmed in the FY14 CIP and \$30 million recommended for consideration in future CIPs. Some major projects during FY14-23 include: a series of prioritized interceptor renewal/asset protection projects (\$31 million); a series of sewer corrosion and odor control projects (\$12 million); sewer siphon structure, manhole, and force main rehabilitation (\$18 million); SCADA and wastewater metering (\$14 million); and member community financial assistance (\$7 million).

The average age of the sewer system is about 65 years old. Approximately 30 percent of sewers are over 100 years old; however, the collection system is in reasonably good condition given its average age. Based on internal TV inspection ratings for gravity sewer pipe, approximately 70 miles (31 percent) are new or are in very good condition (A-rated), 139 miles (61 percent) are in fair to good condition with some damage (B-rated), and 18 miles (8 percent) of interceptors are severely damaged (C-rated). The most critical need for the sewer system is rehabilitation construction that will address long-term sewer asset protection for C-rated pipelines. To meet this need, MWRA developed a series of prioritized interceptor renewal/asset protection projects. The gravity sewer inspection ratings have not been used for force mains, siphons, or outfalls; however, based on available data, these also appear to be in reasonably good condition. MWRA continues to monitor hydrogen sulfide corrosion and odor issues in the collection system to prioritize inspections for affected sewers. TRAC staff oversee the pre-treatment work of municipalities and industries. The Wastewater System Master Plan does not include recommendations for future large scale capital projects to target capacity/optimization projects related to extreme event SSOs. Effective use of future capital resources to address extreme event SSOs will be investigated within the ongoing and recommended modeling/planning studies.

The SCADA systems provide a means of monitoring and controlling facilities and equipment from a remote centralized location, as well as providing a continuous record of facility operations. MWRA's Wastewater SCADA system went through a major upgrade from 2007 through 2009 as part of the Wastewater Central Monitoring/SCADA Implementation Project. This project created a unified SCADA system covering all significant wastewater facilities. New facilities have been incorporated into the system. All wastewater facilities can be monitored and controlled at the Chelsea Operations Control Center using the SCADA system. MWRA's wastewater metering system provides rate-basis data on community flows, as well as additional operational support data for hydraulic modeling, capacity analyses, engineering studies, and community flow component (sanitary/infiltration/inflow) estimates. Upgrades to the SCADA and wastewater metering systems are scheduled to continue throughout the 40-year Master Plan schedule.

Since 1993, MWRA has made a commitment to assist member sewer communities to finance infiltration and inflow (I/I) reduction and sewer system rehabilitation projects within their locally-owned collection systems. Funding of community projects through MWRA's I/I Local Financial Assistance Program is provided as 45 percent grants and 55 percent interest-free five year loans. The program goal is to assist member communities in improving local sewer system conditions to reduce I/I and ensure ongoing repair/replacement of the collection system. It is a critical component of MWRA's Regional I/I Reduction Plan. The FY14 CIP includes a net cost of \$7 million (including loan repayments) for approved local distribution through FY21. The Master Plan includes placeholders for five additional rounds (\$40 million in grant/loans in each round) of CIP funding beginning in FY19 at a net cost of \$18 million each. For the FY14-53 timeframe, a total of \$84 million is identified for community financial assistance.

Attachment A
2013 Water System Master Plan - Summary of Existing and Recommended Projects by Chapter

Last revision 10/31/13

Project	Cost (\$1000)	5 years			10 years			20 years			Total Cost (\$1000)
		FY14-18	FY19-23	FY24-33	FY34-53						
SUBTOTAL - Existing - Land Acquisition - Chapter 5	6,000	6,000	0	0	0	0	0	0	0	6,000	
SUBTOTAL - Recommended - Land Acquisition - Chapter 5	35,000	0	5,000	10,000	20,000	0	0	0	0	35,000	
SUBTOTAL - Existing - Water Treatment - Chapter 6	25,180	25,101	79	0	0	0	0	0	0	25,180	
SUBTOTAL - Recommended - Water Treatment - Chapter 6	53,500	0	7,500	19,000	27,000	0	0	0	0	53,500	
SUBTOTAL - Existing Projects - Transmission and Dams - Chapter 7	426,375	74,135	233,502	118,738	0	0	0	0	0	426,375	
SUBTOTAL - Recommended - Transmission and Dams - Chapter 7	91,825	0	6,100	31,725	54,000	0	0	0	0	91,825	
SUBTOTAL - Existing - Metropolitan System - Chapter 8	598,962	188,319	301,063	99,674	9,906	0	0	0	0	598,962	
SUBTOTAL - Recommended - Metropolitan System - Chapter 8	170,700	0	10,500	103,500	56,700	0	0	0	0	170,700	
SUBTOTAL - Existing - Community Assistance - Chapter 8	(118,000)	3,000	(50,000)	(71,000)	0	0	0	0	0	(118,000)	
SUBTOTAL - Recommended - Community Assistance - Chapter 8	0	0	54,000	63,000	(117,000)	0	0	0	0	0	
SUBTOTAL - Existing - Ancillary Services - Chapter 9	6,987	6,815	172	0	0	0	0	0	0	6,987	
SUBTOTAL - Recommended - Ancillary Services - Chapter 9	54,200	5,370	10,330	15,200	23,300	0	0	0	0	54,200	
SUBTOTAL - Existing - Energy - Chapter 10	9,194	5,542	3,652	0	0	0	0	0	0	9,194	
SUBTOTAL - Recommended - Energy - Chapter 10	0	0	0	0	0	0	0	0	0	0	
SUBTOTAL - Existing - ALL with Community Assistance	954,698	308,912	488,468	147,412	9,906	0	0	0	0	954,698	
SUBTOTAL - Recommended - ALL with Community Assistance	405,225	5,370	93,430	242,425	64,000	0	0	0	0	405,225	
SUBTOTAL - Existing - ALL without Community Assistance	1,072,698	305,912	538,468	218,412	9,906	0	0	0	0	1,072,698	
SUBTOTAL - Recommended - ALL without Community Assistance	405,225	5,370	39,430	179,425	181,000	0	0	0	0	405,225	
TOTAL	1,477,923	311,282	577,898	397,837	190,906	0	0	0	0	1,477,923	

Attachment B
2013 Wastewater System Master Plan - Summary of Existing and Recommended Projects by Chapter

Last revision 9/9/13

Project	Cost (\$1000)	5 years			10 years			Total Cost (\$1000)
		FY14-18	FY19-23	FY24-33	FY34-53	20 years		
SUBTOTAL - Existing Projects - Deer Island - Chapter 6	456,820	188,385	221,679	46,756	0	456,820		
SUBTOTAL - Recommended - Deer Island - Chapter 6	689,700	27,250	15,700	199,750	447,000	689,700		
SUBTOTAL - Existing - Residuals - Chapter 7	103,458	1,549	98,237	3,672	0	103,458		
SUBTOTAL - Recommended - Residuals - Chapter 7	82,320	1,320	0	3,000	78,000	82,320		
SUBTOTAL - Existing - Headworks and Tunnels - Chapter 8	182,817	62,256	120,561	0	0	182,817		
SUBTOTAL - Recommended - Headworks and Tunnels - Chapter 8	110,500	0	500	25,000	85,000	110,500		
SUBTOTAL - Existing - Sewers - Chapter 9	92,818	22,249	51,829	18,740	0	92,818		
SUBTOTAL - Recommended - Sewers - Chapter 9	282,400	7,400	20,000	128,000	127,000	282,400		
SUBTOTAL - Existing - Pump Stations and CSO Facilities - Chapter 10	27,965	27,621	344	0	0	27,965		
SUBTOTAL - Recommended - Pump Stations and CSO Facilities - Chapter 10	288,000	3,000	86,000	56,000	143,000	288,000		
SUBTOTAL - Existing - CSO Control Plan (MWRA and Community Managed) - Chapter 11	49,400	48,066	1,271	63	0	49,400		
SUBTOTAL - Recommended - CSO Control Plan (MWRA and Community Managed) - Chapter 11	0	0	0	0	0	0		
SUBTOTAL - Existing - SCADA and Metering - Chapter 12	22,000	6,231	7,692	8,077	0	22,000		
SUBTOTAL - Recommended - SCADA and Metering - Chapter 12	20,480	0	240	5,000	15,240	20,480		
SUBTOTAL - Existing - Clinton - Chapter 14	14,347	10,753	3,594	0	0	14,347		
SUBTOTAL - Recommended - Clinton - Chapter 14	26,875	775	7,100	9,000	10,000	26,875		
SUBTOTAL - Existing - Community Support - Chapter 15	-6,000	2,000	-5,000	-3,000	0	-6,000		
SUBTOTAL - Recommended - Community Support - Chapter 15	90,000	0	10,000	41,000	39,000	90,000		
SUBTOTAL - Existing - ALL	943,625	369,110	500,207	74,308	0	943,625		
SUBTOTAL - Recommended - ALL	1,590,275	39,745	139,540	466,750	944,240	1,590,275		
TOTAL	2,533,900	408,855	639,747	541,058	944,240	2,533,900		

CHAPTER 1

INTRODUCTION

1.01 Overview of MWRA

Massachusetts Water Resources Authority (MWRA or Authority) was established by the Massachusetts Water Resources Authority Act, Chapter 372 of the Acts of 1984 of the Commonwealth of Massachusetts. In 1985, responsibility for water distribution for 46 municipalities and sewage collection and treatment for 43 municipalities was transferred from the Metropolitan District Commission (MDC) to the MWRA. MWRA's facilities span from the Quabbin Reservoir in western Massachusetts to the Deer Island Treatment Plant in Boston Harbor. Approximately 2.5 million people, about 40 percent of the total population of Massachusetts, live in the communities served in whole or in part by MWRA.

MWRA is an independent public agency with the ability to raise revenues from ratepayers, bond sales and grants. In addition to its operating responsibility, MWRA was created to modernize the area's water and sewer systems and clean up Boston Harbor. MWRA's long-term business plan emphasizes improvements in service and systems and includes aggressive performance targets for operating the water and wastewater systems and maintaining new and existing facilities. Parallel to MWRA's goal of carrying out its capital projects and operating programs is its goal of limiting rate increases to its customer communities. The need to achieve and maintain a balance between these two goals is a critical issue in the development of both the Wastewater and Water System Master Plans. MWRA maintains an extensive web site at www.mwra.com that provides information on the development of the agency, organization of the Authority, water and sewer systems, customer communities, etc.

1.02 Purpose of the Wastewater System Master Plan

MWRA's Wastewater System Master Plan presents a long-term vision of the capital development needs of the wastewater system and the actions planned for the next forty years to meet those needs. The primary purpose of this Plan is to ensure that key staff from across the Authority engage in proactive planning to enhance system performance while minimizing long-term costs to MWRA ratepayers. The delivery of sewage collection, treatment and disposal service to a major region of the state (over 2 million customers) represents an essential public service. It is MWRA's responsibility to protect public health, promote environmental quality improvements, support a prosperous economy, maintain customer confidence, and minimize sewer charges. To fulfill this responsibility, significant expenditures for system rehabilitation and improvements will continue. The Wastewater System Master Plan identifies system/facility conditions, operational risks and capital project needs. The Master Plan accounts for all projects currently programmed in MWRA's FY14 Capital Improvement Program (CIP), and additional projects recommended for consideration in future CIPs. Projects have been prioritized (see Section 1.03) and an implementation schedule recommended that corresponds with MWRA's annual CIP development and 5-year CIP cap cycles.

Concurrent with development of the 2013 Wastewater System Master Plan, MWRA has also developed a companion 2013 Water System Master Plan. Preparation of a Master Plan (including periodic updates) was recommended by the MWRA Advisory Board to provide a more thorough context for developing, analyzing, and evaluating the annual CIP and is intended to serve as an important tool for future planning, budgeting and rate setting decisions.

1.03 Planning Approach and Time Frame

In its 28-year existence, MWRA has constructed billions of dollars of facilities to repair, replace, and modernize aging infrastructure. MWRA has completed the \$3.8 billion Boston Harbor Project and has invested over \$600 million in upgrades to sewer interceptors, pump stations, and headworks facilities. In addition, MWRA has attained 94 percent implementation of the approved \$888.1 million Combined Sewer Overflow (CSO) Control Plan, including completion of 29 of 35 projects with the six remaining projects to be finalized by December 2015 (in compliance with Federal Court Order). The estimated replacement value of MWRA's wastewater system assets is over \$6 billion. Having completed most of the large, mandated construction projects, MWRA is now transitioning to the rehabilitation of those portions of the system that have not been replaced and planning for maintenance and asset protection of newer facilities. Development of periodic updates to the Master Plan will continue the transition with respect to capital projects, shifting MWRA's primary focus from construction of new facilities to maintenance and rehabilitation/replacement.

For the 2013 Master Plan, MWRA has selected a 40-year planning period through FY53. The Master Plan focuses on projects programmed into the FY14 CIP and projects that are proposed to generate capital spending during the next two 5-year CIP cap cycles FY14-18 and FY19-23. Following these two 5-year periods, additional 10-year (FY24-33) and 20-year (FY34-53) planning periods are utilized. Estimates of project costs and schedules over the shorter term are expected to be more reliable than looking ahead to the out-years.

All projects have been prioritized on a scale from 1 to 5, with the following designations: 1-critical or under construction; 2-essential; 3-necessary; 4-important; and 5-desirable. A detailed list of Master Plan Priority Ratings for the Wastewater System is presented later in this Chapter in Section 1.08. Highest priority projects will resolve critical threats to public health and prevent imminent system failure resulting in significant service loss. High priority projects will improve system reliability and maintain effluent/residuals quality. Lower priority projects will optimize system performance, assure future capacity, and provide more efficient operation. Project ratings are assigned by MWRA senior managers in concert with Planning and Coordination Department staff. All MWRA projects will be further reviewed and priorities will be reconsidered during the annual CIP development process.

1.04 Organization of the Master Plan

The 2013 Wastewater System Master Plan is organized into Chapters of distinct topics and/or separate asset classes (such as Deer Island, Residuals, Headworks, etc.). Each chapter that recommends capital projects includes a summary section that provides an overview of major findings, recommendations, costs, and project schedules. The 2013 Water System Master Plan has been compiled in a separate volume using a consistent format. The Master Plan Executive

Summary presents the combined programmed and recommended capital projects for both water and wastewater systems.

1.05 Periodic Updates

Development of MWRA's Master Plan is intended to be an ongoing process rather than a static document. The 2013 Wastewater System Master Plan is an update of the 2006 Wastewater Master Plan. The 2013 Master Plan presents a broad range of recommended projects, some critical (to be completed in the short-term), some lower priority (to be completed in the long-term). Changes in scope, details and scheduling of certain projects may be required over time to respond to emergencies, new regulations, emerging technologies, etc. Although the Master Plan will map out major expenditures for the wastewater system for many years, conditions change and flexibility is important. The Master Plan is intended to be reviewed annually as an integral component of MWRA's CIP development and will be revised periodically to reflect new initiatives and/or major changes in priorities. A complete Master Plan review/update is recommended to be performed no less than every five years.

1.06 MWRA Business Plan

Separate and distinct from the Master Plan, MWRA maintains and periodically updates its Business Plan. The MWRA Business Plan is a strategic roadmap that presents specific steps that the agency will undertake to continue to provide excellent quality drinking water; meet high environmental standards for wastewater effluent discharge; expand use of renewable energy in its facilities, as well as implement other sustainability practices; improve the capacity, performance, and reliability of its water and wastewater systems; promote investor and ratepayer confidence in Authority financial management; and manage its staff and support systems resources effectively. Many themes overlap between the Master Plan and the Business Plan, however, the intended uses and target audience are quite different. The Master Plan is a very detailed listing, explanation, and prioritization of both short and long-term projects that will impact MWRA's capital development needs. Alternatively, the Business Plan is a concise listing of MWRA goals over a relatively short, generally five year, timeframe. A bullet list of objectives and strategies to achieve each stated goal is included in a one page table format. The concise nature of the Business Plan makes it effective as both a communications document and a management tool.

1.07 Sources of Information

The reports and planning documents listed below provide a great deal of additional detail on the MWRA wastewater system and recommended capital improvements.

Wastewater Engineering and Management Plan for Boston Harbor - Eastern Massachusetts Metropolitan Area - EMMA Study, March 1976 - This report, including a Summary Report, Main Report, and 16 Technical Data Volumes (with additional appendixes), was prepared to provide guidance for wastewater management to the Metropolitan Sewer District for an 80 year planning period.

Wellesley Extension Sewer Facilities Plan and Environmental Information Document, December 1984 - This report presents the engineering and environmental evaluations and recommendations for replacement/repair/upgrade of the Wellesley Extension Sewer and Wellesley Extension Relief Sewer.

MWRA Secondary Treatment Facilities Plan, March 1988 – This is an eight volume report with each volume detailing a separate aspect of the planning portion of the Boston Harbor Project.

Wastewater Metering System Study, August 1988 - This report recommended design and construction of a wastewater metering system to develop community flow data for evaluation of various sewer rate methodologies.

Framingham Extension Relief Project Final Environmental Impact Report, January 1989 and 1982 Facilities Plan - These reports present the engineering and environmental evaluations and recommendations for upgrades of the Framingham Extension Sewer.

New Neponset Valley Relief Sewer Final Environmental Impact Report and Supplemental Final Facilities Plan, May 1990 - This report presents the engineering and environmental evaluations and recommendations for upgrades of the New Neponset Valley Sewer system.

Final Facilities Plan and Environmental Impact Report for Braintree-Weymouth Relief Facilities, May 1993 - This report presents the engineering and environmental evaluations, and recommendations for replacement and repair of the Braintree-Weymouth Interceptor and pump station, to increase hydraulic capacity and to reduce wastewater overflows.

Quincy Pumping Stations Facility Plan and Environmental Information Document, July 1993 - This report presents the engineering and environmental evaluations, and recommendations for replacement/upgrade of the Hough's Neck, Quincy, and Squantum Pump Stations and force mains.

1994 Final CSO Conceptual Plan and System Master Plan - This report evaluated the cost effectiveness of existing and proposed CSO facilities against other long-term CSO control alternatives, in the context of long-term system-wide wastewater management strategies involving the transport system, infiltration/inflow reduction, and secondary treatment capacity at Deer Island. The report recommended approximately 25 wastewater system improvements to bring CSO discharges into compliance with state water quality standards.

Cummingsville Branch Sewers Facilities Plan, June 1995 - This report presents the alternatives, and the engineering and environmental evaluations for providing increased hydraulic capacity to the Cummingsville Branch Sewer system to prevent surcharging and overflows, and includes recommendations for replacement and rehabilitation of the system.

1996 Siphon Chamber and Connecting Structures Inspection Summary Report - This report provides documented results and recommendations from the inspection of 146 siphon chambers and connecting structures in the MWRA collection system.

Final CSO Facilities Plan and Environmental Impact Report, July 1997 - This report includes facilities planning and environmental assessment for the CSO Control Plan recommended in the 1994 Final CSO Conceptual Plan and System Master Plan. It confirmed or modified the 1994 CSO Conceptual Plan recommendations and presented an updated plan for long-term CSO control.

MWRA Sewerage Division Plan, July 1997 - This Master Plan was written by MWRA staff to provide a long-term guide for Sewerage Division operations, maintenance, capital development and planning decisions in a system-wide format. The plan included a section on the Clinton Wastewater Treatment Plant.

Upgrades to Existing CSO Facilities, Supplemental Environmental Impact Report, September 1998 - This report recommended project changes to implement the 1997 CSO plan, including the addition of dechlorination into the treatment process at CSO treatment facilities.

Upgrades to the Fox Point CSO Facility Supplemental Environmental Impact Report, December 1998 - This report recommended project changes to implement the 1997 CSO plan, including the addition of dechlorination into the treatment process at the Fox Point CSO treatment facility.

1999 Supervisory Control and Data Acquisition (SCADA) Master Plan - This report recommended upgrades to the SCADA system to monitor and control facilities and equipment from a centralized location.

Emergency Evaluation of the High Level Sewer Sections 70 and 71, February 1999 - This report recommended repairs/rehabilitation of a portion of the High Level Sewer.

Re-Assessing Long-Term Floatables Control for Outfalls MWR018, 019 and 020, February 2001 - This report presented updated assessments showing improved system performance and infrequent CSO discharge activations and volumes and proposed deletion of earlier recommended improvements deemed no longer beneficial.

Re-Assessment of CSO Activation Frequency and Volume for Outfall MWR010, April 2001 - This report (including May 31, 2001 supplemental letter report) presented updated assessments showing improved system performance and infrequent CSO discharge activations and volumes and proposed deletion of earlier recommended improvements deemed no longer beneficial.

MWRA Collection System Operation and Maintenance Manual, June 2001 - This manual was developed to meet a requirement of MWRA's NPDES Permit and describes operation and maintenance activities for the collection system.

MWRA Current Equipment and Operational Summary for Wastewater Transport Facilities, June 2002 - This report provides detailed equipment and operational information specific to each facility as an existing conditions baseline for the Wastewater Hydraulic Optimization Project.

2003 Wastewater Characterization Study - This report identified the various components in the wastewater stream with hydrogen sulfide being a component of interest.

Upper Neponset Valley Relief Sewer Phase III Report Final Environmental Impact Report, February 2003 - This report summarizes the alternatives for hydraulic relief of the Upper Neponset Valley Sewer system to eliminate sewer system overflows, and presents the recommended alternative and associated mitigation measures.

Final Variance Report for Alewife Brook and the Upper Mystic River, July 2003 - This report (including July 8, 2003 supplemental letter report) confirmed a revised plan for CSO control for the Alewife Brook watershed.

Final Report on Hydraulic Optimization Alternative Analysis, August 2003 - This report presents the results of hydraulic evaluations of a series of hydraulic optimization alternatives originally identified in a workshop conducted with the consultant and MWRA staff on March 27, 2003 under the Wastewater Hydraulic Optimization Project.

Rutland-Holden Trunk and Relief Sewers, Hydraulic Capacity Evaluation, December 2003 and Sewer System Evaluation Survey, November 2003 - These reports present results of evaluations of the Rutland – Holden sewers.

2004 Cottage Farm CSO Facility Assessment Report - This report evaluated the treatment performance of the Cottage Farm CSO facility, recommended system optimization improvements, and demonstrated that expanding the facility's detention/storage capacity would not be cost-effective.

East Boston Branch Sewer Relief Project Reevaluation Report, February 2004 - This report evaluated CSO control alternatives for East Boston outfalls and confirmed the cost-benefit of the 1997 interceptor relief plan with minor adjustments.

Supplemental Facilities Plan and Environmental Impact Report on the Long-term CSO Control Plan for North Dorchester Bay and Reserved Channel, April 2004 - This report presented a revised plan for North Dorchester Bay outfalls recommending a storage tunnel controlling CSOs up to the 25-year storm and separate stormwater discharges up to the 5-year storm.

MWRA Long Term CSO Control Plan, Fort Point Channel Sewer Separation and System Optimization Project, Level of Control at CSO Outfalls BOS072 and BOS073, June 2004 - This report evaluated alternatives for controlling CSO discharges at outfalls BOS072 and BOS073, recommending sewer separation and CSO regulator modifications.

Recommendations and Proposed Schedule for Long-Term CSO Control for the Charles River, Alewife Brook and East Boston, August 2005 and MWRA Revised Recommended CSO Control Plan for the Charles River, Typical Year CSO Discharge Activations and Volumes, November 2005 - Together these reports recommended additional improvements and higher level of control for the Cottage Farm facility and other Charles River CSO outfalls. They affirmed revised recommended plans for Alewife Brook and East Boston, proposed new schedule milestones, and raised the number of recommended CSO control projects to 35.

December 2006 MWRA Water and Wastewater System Master Plan - This report was MWRA's first comprehensive Master Plan that presented a long-term (40 year) vision of the capital development needs for both the water and wastewater systems.

Prison Point Optimization Study, April 2007 and Proposed Modification of Long-Term Level of Control for the Prison Point CSO Facility, April 2008 - These reports recommended improved operation of wet weather influent gates at Prison Point CSO facility to maximize in-system storage and minimize treated discharges from the facility.

Concept Design Report on Solids Handling Systems, August 2009 and Concept Design Report for Remote Headworks, August 2009 - These reports present the investigations, inventory, evaluations, findings and conclusions of the equipment and systems in the three remote headworks in order to upgrade the headworks. The reports include itemized lists of over 1,000 improvement recommendations.

Residuals Condition Assessment/Utilities Reliability Study, July 2010 - This report evaluated all facility equipment and support systems at the residuals pellet plant.

FY12 Final Capital Improvement Program (CIP) - This report, the FY12 version of MWRA's annual CIP, lists all MWRA capital projects approved by the MWRA Board of Directors for funding and each project's anticipated schedule and expenditure forecast.

FY13 Final Capital Improvement Program (CIP) - This report, the FY13 version of MWRA's annual CIP, lists all MWRA capital projects approved by the MWRA Board of Directors for funding and each project's anticipated schedule and expenditure forecast.

FY14 Final Capital Improvement Program (CIP) - This report, the FY14 version of MWRA's annual CIP, lists all MWRA capital projects approved by the MWRA Board of Directors for funding and each project's anticipated schedule and expenditure forecast.

Annual Progress Report for the Combined Sewer Overflow Control Plan - This report is filed annually (by March 15) in compliance with the Federal District Court Order in the Boston Harbor Case (U.S. v. M.D.C., et al., No. 85-0489-RGS). Each annual report describes the progress of work to implement the Long-Term Control Plan relative to milestones in the Court-ordered schedule as well as related benefits achieved.

Annual National Pollutant Discharge Elimination System (NPDES) Compliance Summary Report - This report is compiled annually to summarize monitoring and compliance data collected and analyzed by the MWRA's Environmental Quality Department (ENQUAD).

Industrial Pretreatment Program Annual Report (Industrial Waste Report) - This report is compiled annually to document MWRA's ongoing efforts to implement the requirements of 40 CFR Part 403, General Pretreatment Regulations by the Toxic Reduction and Control (TRAC) Department.

MWRA Five Year Progress Report - This report is prepared by MWRA every five years in accordance with Section 22(b) of Chapter 372 of the Acts of 1984 (MWRA's Enabling Act). The most recent Five Year Report for the period 2005-2010 was completed in February 2011. The report provides an overview of the accomplishments and challenges of MWRA.

1.08 Master Plan Priority Ratings for Wastewater System Projects

As noted in Section 1.03, all projects in the Wastewater System Master Plan have been prioritized on a scale of 1 to 5. A detailed list of priority ratings is presented below. This same prioritization system is also used for new projects proposed in the annual CIP process via the Project Prioritization Assessment Worksheet, whether or not the new project was previously recommended in the Master Plan.

Priority One **Critical/Emergency** Risk moderate to high/Consequence very high

Projects which:

- Resolve emergencies or critical threats to public health or worker health and safety
- Prevent imminent failure of the system and significant loss of service

Priority Two **Essential Projects** Risk variable/Consequences high

Projects which are essential to:

- Critical facility assessment
- Fix existing reliability or capacity problems during dry weather flow conditions
- Reduce sanitary sewer overflows from the MWRA system
- Address facilities in poor condition where the ability to provide uninterrupted service or adequate flow is compromised.
- Upgrade or maintain emergency backup facilities in poor condition
- Meet minimum hydraulic performance requirements and service needs
- Implement MWRA's approved CSO control plan
- Maintain wastewater effluent and residuals quality
- To comply with mandated legal, regulatory or statutory requirements

Priority Three **Necessary Projects** Risk moderate to high/Consequence moderate to low

Projects which are necessary to:

- Improve public health and worker safety
 - Restore the system's infrastructure where it is seriously deteriorated
 - Improve hydraulic performance
 - Significantly improve the effectiveness, efficiency, or reliability of system operations and service delivery including where appropriate, the ability to monitor the system
 - Maintain consumer confidence
 - To comply with other legal, regulatory or statutory requirements
-

Priority Four **Important Projects** Risk moderate/Consequences low

Projects which are important to:

- Maintain the integrity of the system's infrastructure
 - Produce significant cost savings or revenue gains for MWRA
 - Monitor system needs and plan appropriate longer-term responses
 - Provide acceptable working conditions at field sites and at maintenance support facilities
 - Implement the regional I/I plan
-

Priority Five **Desirable Projects** Risk/Consequence both low

Projects which are desirable because they would:

- Yield worthwhile cost savings, revenue gains, or efficiency improvements for MWRA
- Protect the long term value and usefulness of system assets
- Solve future problems and conditions which are expected to arise in the latter half of the planning period
- Be beneficial towards the improved operation of a local system

CHAPTER 2

MISSION, GOALS AND OBJECTIVES

2.01 MWRA Mission

MWRA's mission is to provide reliable, cost-effective, high-quality water and sewer services that protect public health, promote environmental stewardship, maintain customer confidence, and support a prosperous economy.

MWRA's mission specific to sewage collection, treatment and disposal is established in the Enabling Act, including: efficient and economical operation; repair, replacement, rehabilitation, modernization, and extension of the system; system-wide planning and professional and productive management; reduction of infiltration and inflow in the service area; financing capital and operating expenses on a self-sustaining basis; and establishment and administration of equitable charges.

2.02 Wastewater Goals and Objectives

To set priorities and to guide the planning process, the mission can be translated into the following goals for the wastewater system:

Goal 1: Provide reliable and safe sewer service.

Goal 2: Provide environmentally sound wastewater collection and treatment, pretreatment, residual disposal, and combined sewer overflow control.

Goal 3: Assure appropriate future wastewater collection and treatment capacity.

Goal 4: Manage regional sewer service efficiently and cost-effectively.

For each goal, objectives have been developed to clarify how each goal will be met and to help prioritize the commitment of resources efficiently. The objectives express the philosophy and emphasis that is to be reflected in program planning and project implementation and identify where efforts should be focused and what approaches should be followed in assessing conditions, developing solutions, implementing improvements and meeting appropriate performance standards. These objectives reflect the needs and priorities of the existing wastewater system, as well as the need to plan and adapt to future priorities driven by member communities, regulatory change, or external events.

Individual projects identified during the master planning process have been prioritized. A recommended implementation timetable has been developed to correspond with MWRA's CIP development cycle, with an eye toward the Board's establishment of a spending cap for the FY14-18 period. MWRA's annual CIP development process will refine costs, schedules, cash-flows, and priorities. Ultimately, project scheduling in the CIP will need to balance: (1) system needs, (2) financial and rates implications, and (3) project staffing considerations.

Goal 1: Provide reliable and safe sewer service.

Dependable, uninterrupted sewage collection, transport, and disposal is an essential public service that is integral to the health, safety, and economic well being of the region's population. Therefore, MWRA's goal is to operate and maintain the sewer system so that service interruption is kept to an absolute minimum, while customer and workforce safety is maximized.

Objectives

- 1) Maintain system capacity: Operate and maintain the sewer system to provide essential day-to-day sewage collection, pumping and disposal.
- 2) Ensure facilities meet condition standards: Identify and rehabilitate or replace facilities and key assets that are in poor condition, are hydraulically deficient, or failing to meet desired performance levels. Identify and prioritize key points within the sewer system where failure or shutdown could lead to an unacceptable disruption in service.
- 3) Use effective planning to minimize risks: Implement and improve practices to inspect, monitor, and maintain the system and replace key equipment in an efficient way to reduce the risk of service disruptions, such as: pipeline blockages, equipment failure, etc. Plan, practice, and implement effective emergency operations procedures to minimize potential public health impacts.
- 4) Monitor system performance: Implement and enhance measures for continual monitoring of key system performance parameters.
- 5) Support work force safety: Provide appropriate workplace and field site conditions and equip crews with the tools, materials, information and training necessary to carry out operational, maintenance, and repair duties safely. Prevent the introduction of hazardous materials into the sanitary sewer system to protect worker health and safety during operation and maintenance activities.
- 6) Support customer communities: Provide technical and financial assistance to customer communities and coordinate emergency operations procedures with local officials to minimize potential public health impacts, including sanitary sewer overflows (SSOs), and basement backups.

Goal 2: Provide environmentally sound wastewater collection and treatment, pretreatment, residual disposal, and combined sewer overflow control.

Since its inception, MWRA has invested significant funds into sewer system relief, wastewater treatment, and combined sewer overflow (CSO) controls to promote environmental quality improvements and meet regulatory requirements. Many capital improvements have been completed and MWRA resources are now being focused on proper operation, maintenance and repair of new facilities, so that environmental quality improvements are not compromised.

Objectives

- 1) Provide effective wastewater treatment: Discharge treatment plant effluent that meets, or cost-effectively exceeds, the quality standards set by federal and state regulations and National Pollutant Discharge Elimination System (NPDES) Permits. Monitor emerging trends in treatment technologies.
- 2) Implement effective federal, state, and local pretreatment standards: As a Publicly Owned Treatment Works (POTW) that receives wastewater from sources subject to National Pretreatment Standards and other industrial users subject to the General Pretreatment Regulations for Existing and New Sources of Pollution (40 CFR Part 403), MWRA is required to operate a pretreatment program (per the regulation) to:
 - Prevent the introduction of pollutants into the sanitary sewer system which will interfere with the operation of the sewer system, including worker health and safety during operation and maintenance activities, and which will interfere with MWRA's use or disposal of residuals from the treatment of sanitary sewerage;
 - To prevent the introduction of pollutants which will pass through the treatment works or otherwise be incompatible with the treatment works; and,
 - To improve the opportunities to recycle and reclaim municipal and industrial wastewaters and residuals.
- 3) Provide effective residuals processing and disposal: Process and dispose of wastewater residuals cost-effectively using methods that meet the quality standards set by federal and state regulations.
- 4) Provide effective wastewater collection and CSO control: Manage the sewer system in order to provide effective and reasonable wastewater collection service to member communities, comply with the requirements of NPDES permits, maximize wastewater flow to the treatment plant to minimize CSOs and sanitary sewer overflows (SSOs), and minimize the impact of sewer odors. Implement the approved Long-Term CSO Control Plan and manage the sewer system in accordance with MWRA's Nine Minimum Controls compliance documentation.
- 5) Provide effective monitoring and reporting of environmental impacts: Implement the Ambient Monitoring Plan for the MWRA Effluent Outfall and monitor CSO impacts as required under MWRA's NPDES permit and the CSO variances for the Charles River and Alewife Brook/Mystic River.

- 6) Track changes in wastewater legislation and regulations: Track and evaluate modifications to water quality criteria, wastewater treatment, pretreatment, CSO, and sewer system legislation and regulations. Actively represent MWRA's interests in the development and implementation of environmental regulations and policies.
- 7) Promote member community and customer confidence: Promote member community and customer confidence in MWRA's ability to provide environmentally sound sewage service and effectively monitor and report environmental impacts. Promote greater awareness and educate the community, businesses, and households on how to reduce the introduction of toxic contaminants and hazardous materials into the wastewater system to improve effluent and residual quality.

Goal 3: Assure appropriate future wastewater collection and treatment capacity.

System-wide master planning is essential to efficiently repair and upgrade system infrastructure. MWRA must develop appropriate planning tools, design criteria, and performance standards, and work cooperatively with member communities to assure appropriate future system capacity.

Objectives

- 1) Provide system-wide planning: Periodically update the Wastewater Master Plan to identify baseline system needs and realistic future capacity requirements. The Master Plan will help prioritize and schedule capital projects based on need and affordability. Implement facilities planning for priority projects identified through the master planning process to assure future capacity.
- 2) Update and refine mapping and modeling tools: Use up-to-date modeling and mapping tools to facilitate system analyses and decision-making. Support records management activities that promote the documentation of accurate, comprehensive, and up to date information that is accessible to appropriate staff.
- 3) Develop appropriate performance standards: Work cooperatively with member communities to develop reasonable and appropriate design criteria performance standards to evaluate existing and future system capacity needs.
- 4) Monitor changes in the collection system: Track and review proposed community system changes, development projects, and other activities that may affect sewer system flows. Consider requests for system expansion in the context of current and anticipated system capacity and within the requirements of MWRA's Enabling Act and MWRA policies. Assess impacts and promote mitigation measures in order to preserve long-term collection, transport, and treatment performance consistent with goals.
- 5) Implement Regional I/I Reduction Plan: Work cooperatively with member communities and continue to implement the regional I/I reduction plan to reduce infiltration and inflow entering the MWRA-owned and community-owned collection system. The reduction of I/I provides capacity for transport of sanitary flow.

Goal 4: Manage regional sewer service efficiently and cost-effectively

As a public agency, an important portion of MWRA's mission is to manage the sewer system efficiently and cost-effectively and to minimize sewer charges. Careful attention will be given to efficiency, sustainability of resources, and cost-effectiveness in all activities and decisions to provide the greatest value to the ratepayers while meeting appropriate standards of service.

Objectives

- 1) Maximize efficiency and minimize costs: Operate and maintain the wastewater collection and treatment system to achieve efficient and economical system performance. Emphasize lower-cost preventive maintenance actions to avoid more costly future expenditures for repair or replacement. Continue to implement reliability-centered maintenance. Where appropriate, implement preventive measures that will extend asset life.
- 2) Implement sustainable and energy efficient practices: Continue to consider opportunities to reduce the energy used to operate the MWRA wastewater system; purchase renewable power where appropriate; and, continue to develop solar, wind and hydroelectric facilities at locations within the system as feasible. Also, continue to improve the opportunities to recycle and reclaim municipal and industrial wastewaters and residuals.
- 3) Maintain and enhance measurement and monitoring technologies: Continue to support measurement and monitoring technologies, including SCADA, to facilitate accurate and reliable sewer rate basis data and monitoring of flow conditions for the purposes of daily and emergency operations, CSO and SSO control, hydraulic modeling, and planning analyses. Review new technologies and implement system upgrades, as appropriate, for improved system monitoring and control that will yield benefits in terms of operational efficiency, flow control and data accuracy.
- 4) Support work force productivity: Support the productivity of the work force by providing appropriate workplace and field site conditions and equip crews with the tools, materials, training, and information necessary to carry out operational, maintenance, and repair duties efficiently and cost effectively. Move forward with MWRA succession planning to assure continuity of operations.
- 5) Optimize system operations: In designing long-term improvements, look for opportunities to optimize operation and maintenance of the system.

CHAPTER 3

HISTORY AND BACKGROUND

3.01 Chapter Summary

This chapter provides background information including a historical perspective of wastewater collection and treatment, a summary of the development and overview of the MWRA regional sewer system, a synopsis of the replacement asset value of MWRA's wastewater infrastructure, an outline of MWRA's management structure, and a timeline of MWRA accomplishments.

3.02 History of Wastewater Collection and Treatment

Modern wastewater collection practices were initiated in Hamburg, Germany and London, England during the 1840s. In the early 1800s, residents of Metropolitan Boston dumped their sewage waste into local streams and Boston Harbor. Due to growing public health problems associated with this practice, Massachusetts created a Board of Health in 1869 to investigate the consequences of discharging sewage into local waterways. In 1876, the Legislature authorized the construction of a system to collect wastewater from 18 communities and dispose of it away from drinking water supplies. The Boston Main Drainage System, built between 1877 and 1884, used a series of tunnels, interceptors, and pumping stations to collect and convey wastewater from the greater Boston area to storage tanks on Moon Island before being released on the outgoing tide into Boston Harbor. In 1889, the Metropolitan Sewerage District was created to oversee the regional sewer collection system. In 1898, the Neponset Valley Sewer System was completed and connected to Moon Island via the Boston Main Drainage System. In 1904, the South Sewerage System was completed with a separate discharge to Boston Harbor at Nut Island. The South Sewerage System conveyed wastewater from the Charles River Watershed, the Neponset River Watershed and areas south of the Boston Main Drainage System to Nut Island. The collection system operated by the Metropolitan Sewerage District became recognized as one of the best in the country, though it provided no treatment, but merely collected wastewater and discharged it into Boston Harbor.

In 1919, the Metropolitan District Commission (MDC) was created to manage Parks, Park Engineering, Waterworks, and Sewerage. The MDC assumed jurisdiction of both the North and South Sewerage Systems. During this period, sewage pollution forced the closure of several harbor clam beds. By 1933, due to worsening pollution, all shellfish taken from the harbor required purification. In 1940, planners recommended the construction of wastewater treatment plants at each of the harbor's three raw sewage discharge locations: Moon Island, Nut Island and Deer Island.

A primary wastewater treatment plant was constructed on Nut Island in 1952 to treat discharge from the South Sewerage System and, in 1968, a primary wastewater treatment plant was constructed on Deer Island to treat flows from the Boston Main Drainage (North) System. The untreated Moon Island discharge was restricted to emergency use only. The Deer and Nut Island Treatment Plants combined received average wastewater flows between 300 and 400 million gallons per day (mgd) and peak flows to 900 mgd.

Growing public awareness and concern for controlling water pollution led to enactment of the Federal Water Pollution Control Act Amendments of 1972 (Public Law 92-500). The 1972 Federal Amendments, as well as updated state laws, mandated primary and secondary treatment for all municipal sewer systems, effectively taking the option for lesser treatment levels away from the states. MDC's treatment plants did not comply with these new requirements.

As additionally amended in 1977, the Federal Water Pollution Control Act became commonly known as the Clean Water Act. The Act established the basic structure for regulating discharges of pollutants into the waters of the United States. It gave the United States Environmental Protection Agency (EPA) the authority to implement pollution control programs such as setting wastewater standards for industry and water quality standards for surface waters. The Act made it unlawful for any person to discharge any pollutant from a point source into navigable waters, unless a permit was obtained under its provisions. It also funded the construction of wastewater treatment plants under the construction grants program and recognized the need for planning to address the critical problems posed by nonpoint source pollution.

Subsequent enactments modified some of the earlier Clean Water Act provisions. Revisions in 1981 streamlined the municipal construction grants process, improving the capabilities of treatment plants built under the program. Changes in 1987 phased out the construction grants program, replacing it with the State Water Pollution Control Revolving Fund, more commonly known as the Clean Water State Revolving Fund. This new funding strategy addressed water quality needs by building on EPA-State partnerships.

Over the years, many other laws have changed parts of the Clean Water Act. See www.epa.gov/lawsregs/laws/cwa.html for more information. Chapter 4 of the Wastewater System Master Plan discusses the regulatory framework affecting MWRA's wastewater system and potential regulatory changes and long-term issues that may impact MWRA.

3.03 Growth of the Sewer Service Area

Growth of the sewer service area is shown in Figure 3-1. A large portion of the metropolitan Boston sewer system was built from the 1880s through 1933. In the 1950s, sewer extensions were made to serve the Hingham North Sewer District, Holbrook and Randolph, as well as Ashland, Framingham, and Natick. During the 1970s, additional sewer extensions added Bedford, Burlington, Wilmington and Westwood.

MWRA's sewer service area today remains essentially the same as that following the expansion from the 1970s. MWRA serves a total of 43 member sewer communities; of these, 42 entire communities are within the service area and only Hingham (North Sewer District) is partially served by MWRA. Any further expansion of the MWRA sewer service area is subject to MWRA's sewer expansion policies as detailed in Section 3.06 of this Chapter.

FIGURE 3-1
Growth Of The Sewer Service Area

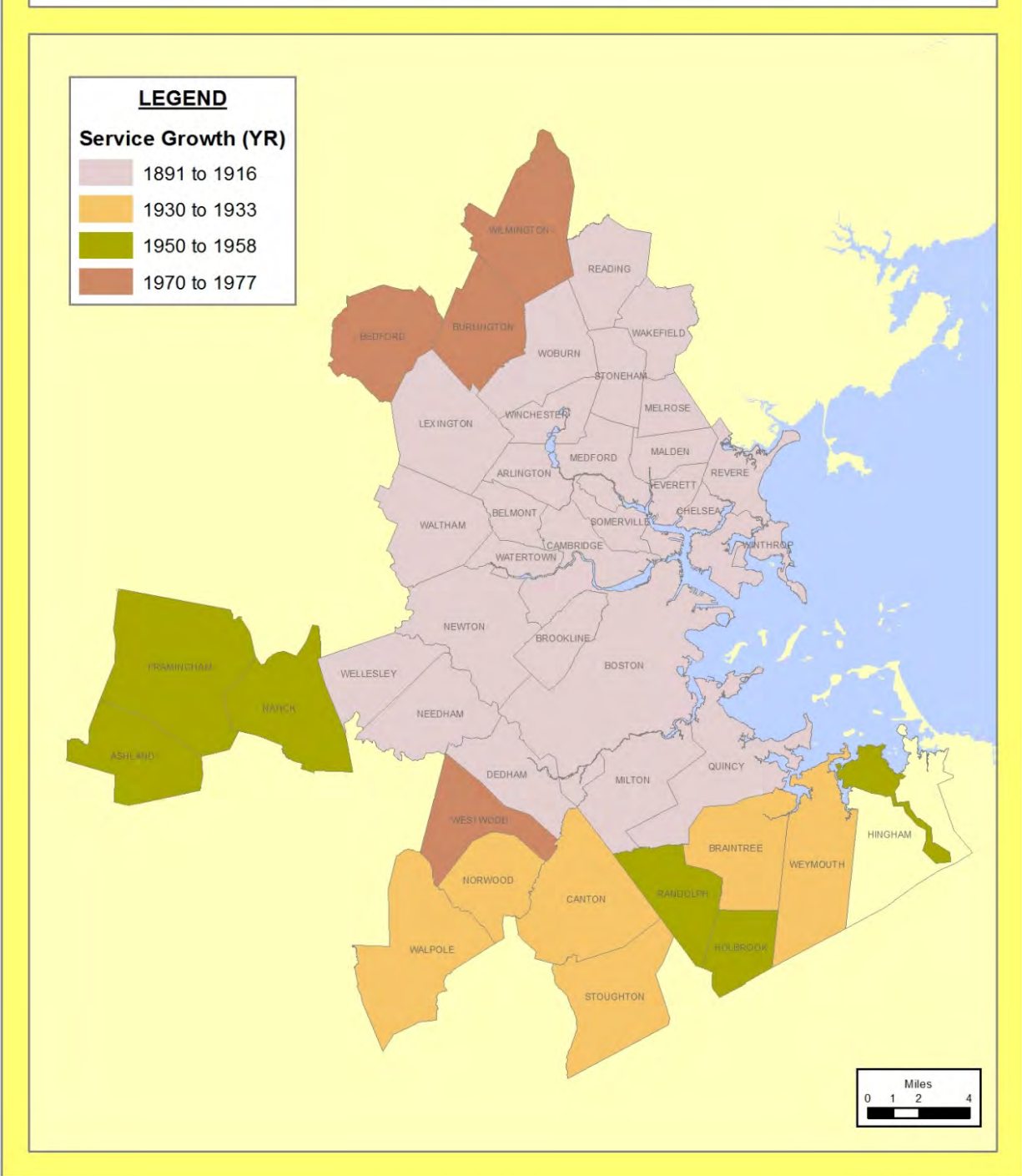

3.04 Transition from MDC to MWRA

By the early 1970s, MDC's Nut Island and Deer Island Treatment Plants were obsolete, in disrepair and often unable to provide an adequate level of treatment. The inability of the system to meet increased wastewater flows, combined with a less advanced level of treatment than required by the Clean Water Act, was a major cause of harbor pollution. In order to provide effective sewer service, the MDC needed the ability to raise sufficient revenues to hire adequate staff, properly maintain facilities and equipment, finance major capital programs, and develop operating budgets that were responsive to existing and future needs. Under the system that existed, it was impossible for MDC to achieve these goals.

In 1982, the City of Quincy sued the MDC for violating the Massachusetts Clean Water Act. Judge Paul Garrity, who presided over the case, ruled that the MDC's practice of releasing inadequately treated wastewater into Boston Harbor violated the state's Clean Water Act. In 1983, the Conservation Law Foundation sued MDC and EPA in Federal Court. In 1984, legislation was enacted to create the Massachusetts Water Resources Authority, an independent agency with the ability to raise revenues from ratepayers, bond sales and grants. MWRA's mission included: modernize wastewater treatment to clean up Boston Harbor, repair and upgrade the collection system, increase staff to improve operations and maintenance, and plan for future system needs. In 1985, the United States on behalf of the EPA brought an action against the Commonwealth of Massachusetts, MDC, MWRA and Boston Water and Sewer Commission for Clean Water Act violations. The federal cases were consolidated into the Boston Harbor Case (D. Mass. C.A. No. 85-0489) and the state case was dismissed. The City of Quincy and the Town of Winthrop were allowed to intervene. In the Boston Harbor Case, Judge A. David Mazzone found MDC liable for Clean Water Act violations and also found MWRA liable as a successor in interest to MDC. As part of the Boston Harbor Case, MWRA was required to undertake certain corrective actions to meet wastewater treatment, effluent discharge and combined sewer overflow (CSO) requirements. MWRA responded by instituting an aggressive schedule to plan, construct and operate a new Deer Island Treatment Plant and regional CSO control facilities to comply with the Clean Water Act. The schedule was incorporated into a court order that has dictated many of the Authority's decisions. In 2000, MWRA completed the last significant milestone of the Boston Harbor Project which related to improvements to MWRA's Deer Island Wastewater Treatment Plant and related facilities. The overall cost of the Boston Harbor Project was approximately \$3.8 billion.

The MWRA continues to be a defendant in the Boston Harbor Case. The only corrective actions remaining in the Boston Harbor Case are CSO-related. As of July 2013, the Authority has a total of 35 CSO projects, 29 of which are complete. The estimated total cost for the Authority's long-term CSO control plan is \$888.1 million.

A time line of major MWRA accomplishments for the wastewater system is presented in Section 3.09, at the end of this Chapter.

3.05 Overview of the MWRA Regional Sewer System

MWRA's Enabling Act (Section 8 (c)) requires the Authority to provide main sewer services for the area consisting of the following political subdivisions: Arlington, Ashland, Bedford, Belmont, Boston, Braintree, Brookline, Burlington, Cambridge, Canton, Chelsea, Dedham, Everett, Framingham, the North Sewer District of Hingham, Holbrook, Lexington, Malden, Medford, Melrose, Milton, Natick, Needham, Newton, Norwood, Quincy, Randolph, Reading, Revere, Somerville, Stoneham, Stoughton, Wakefield, Walpole, Waltham, Watertown, Wellesley, Westwood, Weymouth, Wilmington, Winchester, Winthrop and Woburn. A link to MWRA's Enabling Act (Chapter 372 of the Acts of 1984) is available on: www.mwra.com. To serve the 43 customer communities in metropolitan Boston, MWRA maintains a regional wastewater collection system, a complex network of conduits and facilities that is strongly influenced by seasonal and wet weather conditions. The system average daily flow is approximately 360 mgd, minimum dry weather flow is approximately 260 mgd, peak wet weather capacity to the Deer Island Treatment Plant is 1,270 mgd with additional system capacity available at CSO outfalls. The MWRA collection system includes a network of about 274 miles of sewer pipelines (tunnels, gravity sewers, force mains, siphons, and outfalls); one screening facility; 13 pump stations; six CSO treatment/storage facilities; and four remote headworks facilities.

Community wastewater discharges into the regional collection system are subject to MWRA's Sewer Use Regulations (360 CMR 10.000) which govern the discharge of sewage, drainage, substances, and wastes into any sewer under the control of MWRA, or into any sewer tributary thereto. MWRA's Sewer Use Regulations are intended to protect the public health, safety and welfare, and the environment, and ensure proper and safe operation of the Authority's wastewater treatment facilities by regulating the direct and indirect discharge of wastewater and pollutants to the MWRA's sewerage system.

MWRA's Deer Island Treatment Plant is the centerpiece of MWRA's \$3.8 billion program to protect Boston Harbor against pollution. The plant treats wastewater in compliance with all federal and state environmental standards and is subject to a National Pollutant Discharge Elimination System (NPDES) permit issued for the plant by EPA and MassDEP. A 9.4-mile, 24-foot-diameter outfall tunnel transports effluent into the 100-foot deep waters of Massachusetts Bay. Extensive monitoring ensures that the environment is properly protected. Key components of the Deer Island Treatment Plant include: influent pumps, primary treatment, secondary treatment, sludge digesters, odor control, disinfection, dechlorination, effluent discharge, off-site power supply, and onsite power generation.

When it began operating in 1991, MWRA's sludge-to-fertilizer plant made history by ending sludge discharges into Boston Harbor. The sludge-to-fertilizer plant, located near Fore River in Quincy, recycles organic solids (residuals) left over from the wastewater treatment process into fertilizer. The product is suitable for landscaping, gardening and large-scale agriculture. Using rotating, high-temperature dryers, the plant produces a small, hard granule that is approximately 60 percent organic matter. The pellets contain several important nutrients, such as nitrogen, phosphorus, calcium, sulfur and iron, and because the nitrogen in the fertilizer is in an organic form, it feeds plants slowly over time and minimizes the risk of nitrate pollution.

In addition to operation of regional wastewater facilities for metropolitan Boston, MWRA assumed formal operational responsibility for the Clinton Advanced Wastewater Treatment Plant (AWWTP) in 1987. The plant provides advanced wastewater treatment services to the Town of Clinton and the Lancaster Sewer District. Completed in 1992, MWRA constructed new primary, secondary, and advanced treatment facilities that incorporate rehabilitated portions of the existing plant with new construction. The facilities meet all federal and state environmental standards and the NPDES permit issued by EPA and MassDEP. Key components of the Clinton AWWTP include: preliminary treatment, influent pumps, primary treatment, secondary treatment, advanced nutrient removal, sludge digesters, off-site power supply, on-site power generation using digester gas, odor control, disinfection, and dechlorination. The plant discharges its effluent into the South Branch of the Nashua River in accordance with the discharge limits of the facility's NPDES permit. Residual materials are pressed and transported to an MWRA-owned landfill for disposal.

3.06 MWRA Sewer Expansion Policies

MWRA has detailed policies that address the procedures and criteria for handling requests for services to locations outside MWRA's water or sewer service areas. MWRA must approve all extensions of service to entities outside the existing service area (see list of MWRA member communities in Section 3.05) pursuant to the applicable policy noted below. This is the case even when an entity outside the service area is not directly connected to an MWRA-owned interceptor, but instead to a community-owned local sewer that is part of the MWRA service area.

At the present time, the demand for sewer expansion to communities outside the service area is low. None of the communities immediately adjacent to the existing sewer service area have expressed strong interest in becoming MWRA member sewer communities.

MWRA's sewer expansion policies are as follows:

- **OP.04, Sewer Connections Serving Property Partially Located in a Non-MWRA Community.** This policy applies to persons seeking MWRA sewer services for buildings and structures partially within and partially outside MWRA's service area. It is also known as the "Sewer Straddle" policy.
- **OP.11, Admission of New Community to MWRA Sewer System and Other Requests for Sewer Service to Locations Outside MWRA Sewer Service Area.** This policy applies to communities seeking admission to the MWRA sewer system and to all parties seeking sewer services for locations outside the MWRA service area.

3.07 Wastewater System Infrastructure Replacement Asset Value

MWRA's wastewater infrastructure is a network of facilities, structures, sewers, tunnels, and outfalls. In preparation of the 2006 Master Plan, staff developed a replacement asset value (cost valuation) of MWRA's infrastructure using MWRA-specific appraisal data and actual MWRA project cost information. For the 2013 update of the Master Plan, the 2006 replacement asset value analysis was reused (in 2006 dollars) with only minor revisions for new facilities added between 2007 and 2012. MWRA's wastewater infrastructure has an estimated replacement asset value of \$6.66 billion, as shown in Table 3-1 and Figure 3-2. The revisions from the 2006 Master Plan replacement asset value analysis were made in two of the asset class categories in Table 3-1. First, an increase of \$260 million (change from \$370 million to \$630 million) in the Pump Stations and CSO Facilities category was made to account for the following new facilities: Union Park CSO Facility, BOS019 CSO Storage Conduit, Braintree/Weymouth Replacement Pump Station, and North Dorchester Bay CSO Storage and Pump Facilities. Second, an increase of \$150 million (change from \$1750 million to \$1900 million) in the Sewer Pipelines category was made to account for the following new pipelines: Cummingsville Replacement Sewer, Upper Neponset Valley Sewer Replacement, Cottage Farm CSO Brookline Connection pipeline, and East Boston Branch Sewer Relief. The replacement asset value estimates detailed in this Section are used in various Chapters of the Master Plan to help estimate reinvestment needs.

TABLE 3-1
Wastewater System Infrastructure Replacement Asset Value

Asset Class	Replacement Asset Value	% of Total
Deer Island Treatment Plant	\$2,500 million	38%
Deer Island Outfall	\$530 million	8%
Residuals Pelletizing Plant	\$200 million	3%
Cross-Harbor Tunnels	\$660 million	10%
Remote Headworks	\$190 million	3%
Pump Stations and CSO Facilities	\$630 million	9%
Sewer Pipelines	\$1,900 million	28%
Clinton Treatment Plant	\$50 million	1%
TOTAL	\$6,660 million	100%

FIGURE 3-2
Wastewater System Infrastructure Replacement Asset Value Total \$6.66 Billion

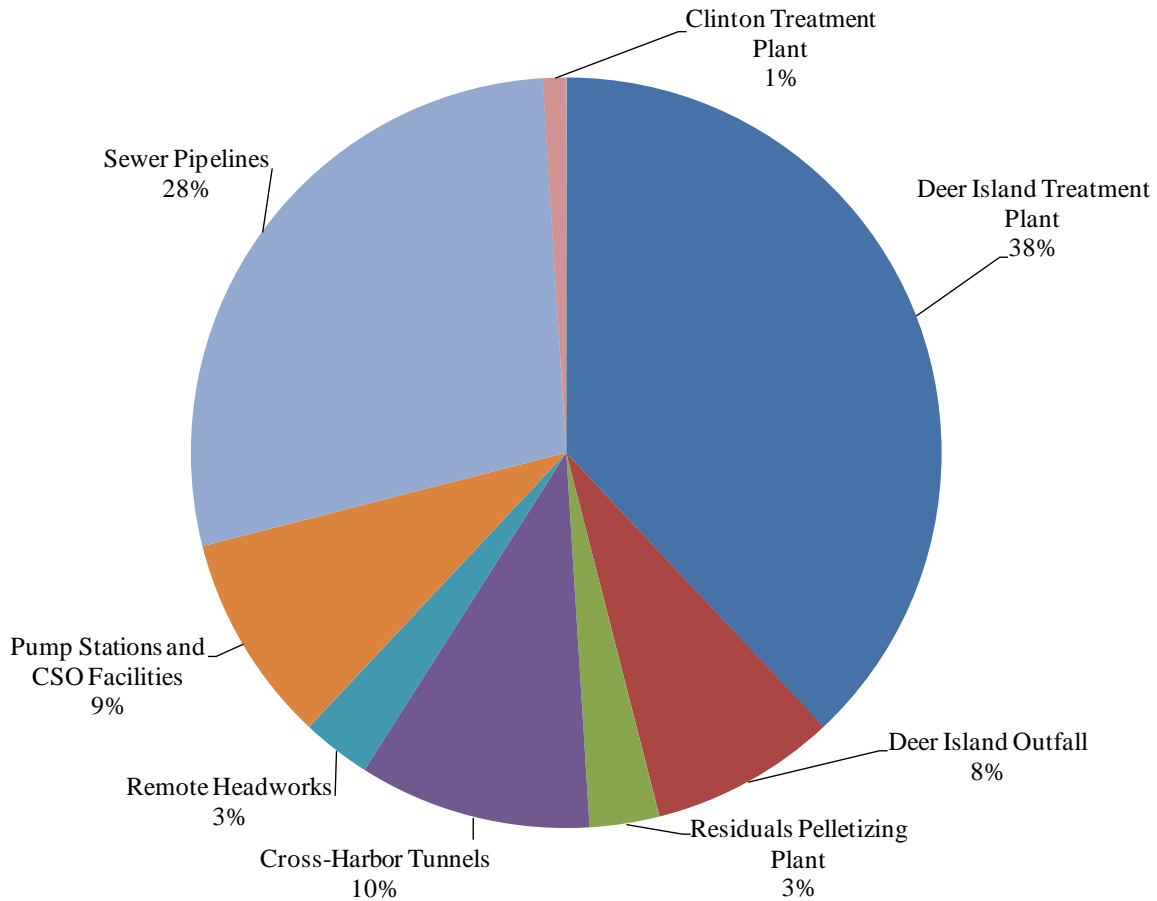

3.08 Outline of MWRA’s Management Structure

MWRA is governed by an 11-member Board of Directors. Eight of the 11 members of MWRA’s Board of Directors are directly or indirectly appointed by elected officials in MWRA’s customer communities. Three members are appointed by the Governor.

MWRA’s Executive Director is responsible for implementing MWRA programs, policies and procedures at the direction of the Board of Directors. Four Divisions carry out MWRA’s mission: the Executive Office under the direction of the Executive Director, Operations under the direction of the Chief Operating Officer, Administration and Finance under the direction of the Director of Administration and Finance, and Law under the direction of the General Counsel. MWRA’s overall staffing level as of 2012 is about 1,200 employees.

Much of the work described in the Wastewater System Master Plan is carried out by the Operations Division under a variety of interrelated departments. Additional information on MWRA’s structure, administration, and staffing can be found on the MWRA web site at www.mwra.com.

3.09 Time Line of MWRA Wastewater System Accomplishments

1985

- MWRA assumed control of the wastewater system from MDC

1986

- Because the level of wastewater treatment inherited by MWRA was below federal standards, Federal Judge David A. Mazzone defined the court ordered schedule for the Boston Harbor Project

1987

- Purchase of Fore River Shipyard in Quincy as staging area for Boston Harbor Project and site for Residuals Pelletizing Facility
- Equipment upgrades at Remote Headworks Facilities completed
- Hayes Pump Station (Wakefield) completed
- Reading Extension Relief Sewer completed

1988

- Deer Island Wastewater Treatment Plant (DITP) groundbreaking

1989

- Both DITP and Nut Island Treatment Plant (NITP) halted discharge of more than 10,000 gallons per day of floatable pollution (grease, oil, and plastics) known as scum
- Fox Point Gravity CSO Facility (Dorchester) completed
- Somerville Marginal Gravity CSO Facility rehabilitation completed
- Belle Isle Siphon rehabilitation completed

1990

- Cross-harbor power cable installed to DITP
- Chelsea Screen House completed

1991

- Phase 1 of Residuals Pelletizing Facility (Quincy) completed allowing daily sludge discharges into Boston Harbor to end
- DITP Pump and Power Station upgrades completed
- Caruso Pump Station (East Boston) completed
- Commercial Point Gravity CSO Facility (Dorchester) completed

1992

- Clinton Wastewater Treatment Plant completed
- NITP intermediate upgrades completed
- Hingham Pump Station completed

1993

- DeLauri Pump Station (Charlestown) completed
- System-wide Wastewater Metering System completed
- MWRA initiated the I/I Local Financial Assistance Program to provide grant/loan funding for member community sewer projects

1994

- Primary treatment component of DITP completed
- Wellesley Extension Sewer Replacement completed

1995

- New Neponset Valley Sewer Pump Station (Canton) completed
- Alewife Brook Pump Station (Somerville) rehabilitation completed

1996

- New Neponset Valley Relief Sewer completed
- Flow-based sewer rate methodology implemented
- Somerville baffle manhole separation (CSO project) completed

1997

- First phase of secondary treatment at DITP completed allowing the plant to meet the requirements of the Federal Clean Water Act for the first time

1998

- Nut Island Headworks and Inter-Island Tunnel connecting the south collection system flows to DITP began operation ending discharges from the Nut Island Treatment Plant
- Second battery of secondary treatment at DITP completed
- Framingham Extension Relief Sewer completed
- Framingham Pump Station completed
- Approval received for CSO Facilities Plan and Environmental Impact Report

1999

- Additional upgrades at Remote Headworks Facilities completed
- Hough's Neck Pump Station (Quincy) completed
- North Metropolitan Trunk Sewer rehabilitation completed
- Public access at Nut Island opened

2000

- Completion of 9.4 mile DITP outfall tunnel moving effluent discharge from the confined waters of Boston Harbor to the deep waters of Massachusetts Bay
- Third and final battery of secondary treatment at Deer Island Treatment Plant completed
- Prison Point Pump Station and Pumped CSO Facility (Cambridge) upgrade completed
- Constitution Beach CSO Treatment Facility (East Boston) decommissioned
- Closing of CSO Outfalls MWR021 and MWR022 on Charles River Esplanade completed
- Hydraulic relief at CSO Outfalls CAM005 and BOS017 completed
- Chelsea Trunk Sewer Replacement and Chelsea Branch Sewer Relief (CSO projects) completed
- CSO Outfall CHE008 repairs completed
- Neponset River sewer separation (CSO project) completed
- Constitution Beach sewer separation (CSO project) completed

2001

- Boston Harbor Project completed
- Phase 2 of Residuals Pelletizing Facility (Quincy) completed
- 15-year contract for residuals operations and marketing awarded
- CSO Facilities upgrades completed at Commercial Point, Cottage Farm, Fox Point, Prison Point, and Somerville Marginal

2002

- Boston Harbor Project performance certification completed
- Quincy Pump Station completed
- Repairs to portions of the West Roxbury Tunnel (Sewer Sections 637 and 638) including the New Haven Street Drop Chamber completed
- MWRA maintenance and office facility in Chelsea opened
- Public access at Deer Island opened

2003

- Squantum Pump Station (Quincy) completed

2004

- Framingham Extension Sewer completed
- Wastewater System GIS mapping project completed

2005

- Intermediate Pump Station (Weymouth) and Braintree-Weymouth Relief facilities completed
- Wastewater Metering System equipment replacement completed

2006

- Judge Richard G. Stears ruled to amend the CSO Control Program schedule with respect to the Charles, Alewife, South Boston, and East Boston basins largely defining CSO Control Plan spending through 2020
- Cummingsville Sewer Replacement Project completed
- Stony Brook Sewer separation (CSO project) completed
- Pleasure Bay Storm Drain Improvements (CSO project) completed
- Fort Point Channel Sewer separation (CSO project) completed

2007

- Union Park CSO Detention/Treatment Facility (South End) completed
- South Dorchester Bay Sewer separation (CSO project) completed
- CSO Plan floatables control and outfall closings projects completed
- BOS 019 CSO Storage Conduit (Charlestown) completed

2008

- Fox Point Gravity CSO Facility (Dorchester) decommissioned
- Prison Point Pump Station and Pumped CSO Facility (Cambridge) optimization project completed
- DITP optimization projects completed
- First roof-mounted solar photovoltaic system (100-kW) at DITP completed
- Braintree-Weymouth Replacement Pump Station (Quincy) completed
- Upper Neponset Valley Sewer Replacement completed
- Cummingsville Replacement Sewer completed
- Rehabilitation of Sewer Sections 80, 83, and 160 completed

2009

- Cottage Farm CSO Facility Brookline connection and inflow controls project completed
- Morrissey Boulevard Storm Drain (CSO project) completed
- Two wind turbines (600-kW each) at DITP completed
- Wastewater Central Monitoring Project construction completed

2010

- Bulfinch Triangle Sewer Separation (CSO project) completed
- East Boston Branch Sewer Relief (CSO project) completed
- Interceptor connection relief and floatables control at CSO Outfalls CAM002 and CAM401B and floatables control at CSO Outfall CAM001 completed
- Second roof-mounted solar photovoltaic system (180-kW) at DITP completed
- DITP grit air handler replacements completed
- Melrose sewer (Melrose Street) interconnection completed

2011

- North Dorchester Bay CSO Storage and Pump Facilities completed
- Charles River CSO Controls completed
- CSO Outfall CAM400 common manhole separation completed
- Wind turbine (1.5 MW) at DeLauri Pump Station (Charlestown) completed
- DITP electrical equipment upgrade (#3) completed
- DITP heat loop pipe replacement construction completed
- DITP steam turbine generator system modifications completed
- Rehabilitation of Sewer Section 624 (Weymouth) completed

2012

- DITP primary and secondary clarifier rehabilitation completed
- DITP gravity thickener improvements completed
- DITP North Main Pump Station motor control center replacement completed
- Rehabilitation of Sewer Section 156 (Everett) completed
- Central Laboratory Upgrades completed
- Reserve Channel sewer separation BWSC CSO contract 3A

2013

- Clinton AWWTP aeration efficiency improvements completed
- Cambridge CSO program CAM004 stormwater outfall and wetlands basin
- Brookline CSO program Sewer Separation completed
- Brookline MWR010 CSO outfall cleaning

CHAPTER 4

WASTEWATER REGULATORY FRAMEWORK

Current and Near-Term Issues and Longer-Term Considerations

4.01 Chapter Summary

The primary regulatory mechanism for the MWRA wastewater system is the National Pollutant Discharge Elimination System (NPDES). The NPDES Program was created by the Clean Water Act of 1972. NPDES regulates point source dischargers such as wastewater treatment plants, direct industrial discharges, combined sewer overflow (CSO) facilities, and stormwater. In Massachusetts, the United States Environmental Protection Agency (EPA) has primacy in writing and administering the permits. Massachusetts is one of a few states that are not yet authorized to administer its own Clean Water Act programs; therefore, the NPDES discharge permits are issued jointly by EPA and Massachusetts Department of Environmental Protection (MassDEP). This chapter details MWRA's NPDES permits for: (1) the Deer Island Treatment Plant (DITP) and related CSO facilities/outfalls; (2) the Clinton Advanced Wastewater Treatment Plant (Clinton AWWTP); (3) stormwater permits for MWRA wastewater facilities; (4) discharges from the Carroll Water Treatment Plant and for hydroelectric generating facilities at Cosgrove and Oakdale; and (5) pesticide application at Wachusett Reservoir. Although the Carroll Water Treatment Plant and hydroelectric generating facilities at Cosgrove and Oakdale are MWRA water system facilities (not wastewater); they are included in this chapter to provide the reader a comprehensive review of MWRA's NPDES permitting issues. This chapter highlights near-term changes expected with the issuance of future NPDES permits, other likely near-term changes in wastewater regulation, and longer-term issues that may affect the regulation of MWRA's wastewater system and the level of treatment required. The activities of MWRA's Environmental Quality Department (ENQUAD) are described.

4.02 NPDES Permitting and Reporting for the DITP and MWRA's CSO Facilities and Outfalls

MWRA's NPDES permit for DITP came into effect August 2000. The permit regulates discharges from the treatment plant outfall in Massachusetts Bay, three CSO treatment facilities (Cottage Farm, Prison Point, and Somerville Marginal), MWRA's five untreated CSO outfalls in the Charles River (MWR010, MWR023, MWR018, MWR019, MWR020), and MWRA's untreated CSO outfall in Alewife Brook (MWR003). MWRA is co-permittee with Boston Water and Sewer Commission for MWRA's Union Park CSO Facility; it is expected that Union Park will be included in MWRA's next DITP permit. The 2000 DITP NPDES permit expired in 2005 and has been administratively continued (its provisions remain in force but cannot be modified) while a new permit is being prepared by EPA.

The DITP NPDES permit requires submission of effluent discharge monitoring reports (DMRs) every month. These reports include data on flow, conventional pollutants, priority pollutants, nutrients, toxicity, CSO discharges, and operations of MWRA's collection system. ENQUAD prepares DMR reports based on monitoring data provided by staff within many MWRA departments, including: DITP, Department of Laboratory Services, Toxic Reduction and Control

(TRAC), Field Operations, and Planning. Since 2000, DITP has received the Platinum award for five years without a violation, five Gold awards for having no permit violations, and six Silver awards (five or fewer violations) from the National Association of Clean Water Agencies. Contaminant loadings from DITP effluent are well below planning predictions.

In addition to the monthly DMRs, the permit has numerous additional requirements, for example: implement the CSO Nine Minimum Controls and the Long-term CSO Control Plan; estimate CSO discharges; produce Best Management Practices and staffing reports for MWRA facilities; and submit annual reports for TRAC requirements, infiltration/inflow reduction, and demand management. In addition, there are extensive ambient monitoring requirements in Massachusetts Bay and Boston Harbor.

One unusual requirement is a contingency plan that uses the ambient monitoring results to report on monitoring thresholds. If the thresholds are exceeded, MWRA must determine if there are adverse impacts that may be caused by the discharge. Threshold exceedances must be reported to regulatory agencies and the public within five days. The monitoring is reviewed at public meetings by an independent Outfall Monitoring Science Advisory Panel convened by EPA. Overall, the environmental monitoring has found that DITP discharges can be detected only locally (as increased ammonium) around the outfall, and no adverse impacts of the discharge on the water quality, plankton, bottom-dwelling communities, sediment contaminants, fish and shellfish of Massachusetts and Cape Cod Bays or Stellwagen Marine Sanctuary have been found.

4.03 NPDES Permitting and Reporting for the Clinton Advanced Wastewater Treatment Plant

MWRA's NPDES discharge permit for the Clinton Advanced Wastewater Treatment Plant (AWWTP) issued by EPA in 2000 regulates the plant's discharges to the South Branch of the Nashua River. The NPDES permit expired in 2005 and has been administratively continued (its provisions remain in force but cannot be modified) while a new permit is being prepared by EPA. The Clinton permit requires submission of DMRs every month. These reports include data on flow, conventional pollutants, priority pollutants, nutrients, and toxicity. The plant has generally met its permit limits; however, it is not unusual for the flow limit to be exceeded in wet weather. In addition, the copper limits in the 2000 permit were sometimes violated prior to the issuance of an Administrative Order by EPA in 2002 which includes less stringent copper limits. The Administrative Order requires annual reporting to EPA on MWRA's efforts to reduce copper in the waste stream. Since 2002, the plant has consistently met the interim copper limits. In 2007, Massachusetts revised its copper water quality standards to include less stringent site specific criteria for the Nashua River. In September 2010, EPA issued a draft NPDES permit for public comment, and in September 2013 EPA re-issued a revised draft permit for public comment. As of October 2013, MWRA provided written comments to EPA on key issues to preserve MWRA's rights to appeal portions of the permit.

The major project cost impact of the 2013 draft NPDES permit on MWRA is substantially more stringent limits on phosphorus, which will require the construction of new phosphorus treatment facilities. More stringent phosphorus limits had been anticipated as there are signs of eutrophication in the river and other dischargers had been receiving more stringent limits. EPA used the 1986 "Gold Book" numerical criterion to calculate phosphorus limits for Clinton. It is estimated that building new treatment facilities for phosphorus removal will cost approximately

\$6.7 million (this project is discussed in more detail in Chapter 14). EPA may also limit aluminum in the effluent if it determines that it has the potential to exceed water quality criteria. In an effort to reduce aluminum in the effluent, MWRA has shifted from using alum to a different chemical for phosphorus treatment at the Clinton AWWTP.

In addition (as of October 2013), EPA is in the process of revising the freshwater water quality criteria for ammonia. The new criteria will likely be more stringent than existing criteria. Effluent limits for ammonia at Clinton AWWTP may drop from the present (a seasonal low of 2 mg/l) to approximately 1 mg/l or slightly lower. There is also a potential for the more stringent limit to apply year-round rather than just in the summer months. The new ammonia criteria may affect the NPDES permit that follows the now-draft permit (as of October 2013), or EPA could re-open the (now draft) Clinton NPDES permit to implement the new ammonia criteria when they are promulgated.

4.04 NPDES Stormwater Permitting and Reporting for MWRA Wastewater Facilities

Stormwater discharges from MWRA facilities are permitted under EPA's 2008 Multi-Sector General Permit for Industrial Facilities (MSGP). This includes treatment plants, headworks, pumping stations, CSO treatment facilities, and residuals facilities. Of MWRA's 25 such facilities, 12 have no storm drains and 12 qualify for "no exposure" status (i.e. stormwater runoff is not exposed to the industrial process) under the MSGP. DITP is the only MWRA facility that is required to carry out stormwater monitoring and reporting under the MSGP.

At DITP, initial sampling in 2009 had indicated elevated bacteria in stormwater discharges to Boston Harbor. However, follow-up sampling showed that stormwater contamination was not related to any wastewater treatment process, but rather was due to runoff from a parking lot where many seagulls roost (a natural source).

There is also a draft Total Maximum Daily Load (TMDL) for pathogens for Boston Harbor which is designated as impaired because it does not always meet the criteria for unrestricted shellfishing. The loading allocations in the draft TMDL are concentrations equal to the state water quality criteria for the water body. It is not clear when an approved TMDL for pathogens for Boston Harbor will be finalized; the draft was issued for public comment in 2005. If there is an approved TMDL for the receiving water, EPA will specify the monitoring requirements for the stormwater permit to ensure consistency with the TMDL. There are unlikely to be other stormwater permit regulatory issues at DITP.

4.05 NPDES Permitting and Reporting for Discharges from the Carroll Water Treatment Plant and for Hydroelectric Generating Facilities at Cosgrove and Oakdale

MWRA applied for an NPDES permit for discharges from the Carroll Water Treatment Plant in 2009. The permit application is for surface water discharges from annual maintenance activities (November – March) in which tanks and equipment are drained and disinfected. The discharges, which are basically dechlorinated drinking water, are tributary to the Wachusett Aqueduct Open Channel which flows into the Sudbury Reservoir. The permit was issued in January 2013.

MWRA's hydroelectric facilities at the Cosgrove Intake Facility and Oakdale Power Station are covered under NPDES general permits. At Cosgrove, stormwater runoff, roof drains, and the turbine floor sump discharge to wetlands tributary to North Brook within the Concord River Watershed. At Oakdale, turbine flow, turbine by-pass flow, cooling water, and sump water are discharged to the Quinapoxet River. There are no regulatory issues associated with these permits.

4.06 NPDES Permitting and Reporting for Pesticide Application at Wachusett Reservoir

MWRA's Pesticide General Permit became active on May 13, 2012. This permit allows for the application of a pesticide (copper sulfate) to control algae growth at Wachusett Reservoir. Specific algae cause taste and odor problems in drinking water. Application of copper sulfate, when necessary, usually occurs in the months of June - September.

The Permit requires visual monitoring and the submission of an annual report detailing activities in the previous year regarding copper sulfate addition. The report requires information for each treatment area and includes a description of the treatment area, pesticide and quantity used, dates of application, adverse incidents, and other relevant information.

4.07 Current and Long-Term Regulatory Issues and Potential Impacts on MWRA

Regulations and enforcement are always changing in response to evolving environmental issues and changing state and federal policy priorities. Examples of changes in regulations occurring now or in the future that affect MWRA wastewater discharges include:

- Bacteria: In 2007, Massachusetts issued new water quality standards for bacteria. Depending on how the standards are interpreted in new NPDES permits, MWRA treatment facilities, particularly those that discharge to the marine environment, and especially in wet weather, may need to use more chemical treatment to meet these standards. Congress has mandated that EPA develop new recreational water quality criteria by fall 2012. EPA must also develop rapid methods for beach monitoring. States generally adopt EPA recommendations. Present indications are that these newest criteria will not directly affect NPDES testing for wastewater treatment, but there is a potential for the criteria to affect the listings for impaired waters and also TMDLs.

It is anticipated that DITP will have to meet both *Enterococcus* and fecal coliform criteria. Depending on how permit limits are defined, it is not clear whether existing disinfection practices will enable DITP to consistently meet an *Enterococcus* criterion. The same is true for CSO treatment facilities. It is anticipated that it will not be a problem for Clinton AWWTP to meet an *E. coli* limit.

- Freshwater Nutrients (phosphorus): EPA has developed very stringent recommended numerical nutrient criteria for most freshwater "ecoregions", including the eastern coastal plain which includes most of Massachusetts. States are encouraged to develop site-specific numerical nutrient criteria, but Massachusetts has not. Nevertheless, phosphorus TMDL analyses have been developed for some impaired waters in Massachusetts, for example the

Charles River. These TMDLs are used to allocate loadings among different sources including treatment plant discharges, CSO, and stormwater.

- Marine Nutrients (nitrogen): No EPA-recommended criteria have yet been developed for marine waters, although EPA has produced a guidance document for states to do so. EPA, together with New England Interstate Water Pollution Control Commission, has convened a working group to develop nutrient criteria for marine waters off the northeast coast. Modeling is likely to play an important role in criteria development and compliance.

Nutrients have been on the radar screen for DITP since the early planning stages. In fact, DITP must submit an annual report that tracks nutrients throughout the plant and also evaluates nutrient removal technologies. Measurable increases in ammonium have been found in the outfall nearfield, but no adverse effects of DITP nutrient discharges have been found. Beginning in 2011, EPA added a station to MWRA's outfall monitoring program at the edge of the mixing zone to obtain more data on whether potential nutrient criteria may be met at that location. If nutrients become a permit or water quality issue, MWRA may need to evaluate nutrient removal at DITP or perhaps at the Fore River Residuals Processing Facility if side-stream only treatment is necessary.

- Sanitary Sewer Overflow (SSO) Rule: EPA's proposed SSO rule included preamble wording prohibiting all SSOs and would have required a collection system management, operations, and maintenance (CMOM) program to manage collection systems to avoid SSOs. This rule was withdrawn; however, EPA and MassDEP will continue to focus on reduction and/or elimination of SSOs. EPA has prioritized this issue as "long-term."
- Stormwater NPDES Permitting: MWRA's future role in stormwater regulation or remediation is likely to be a continuing subject of discussion. For example, the 2009/2010 draft stormwater general permit for small MS4's in the Massachusetts North Coastal Watershed (containing the Charles River), includes dramatic phosphorus reduction requirements for many of the cities and towns with stormwater discharges to the river to comply with the TMDL. These requirements may be very difficult to meet and there have been instances where MWRA has been asked to consider accepting stormwater to facilitate compliance with the nutrient reductions mandated in the draft permit. Such requests may increase in the future. Compliance with the pathogen TMDLs will also be an issue for communities.
- CSO Variances: CSO discharges are allowed in the Lower Charles River Basin and the Alewife Brook/Upper Mystic River through MassDEP-issued variances from water quality criteria. Based on an agreement among EPA, US Department of Justice, MassDEP and MWRA, the variances will be reissued every three years through December 2020. After this date, MassDEP is expected to make long-term water quality standards determinations for these receiving waters based on the performance of MWRA's long-term control plan, the impacts of non-CSO sources of pollution, and an updated analysis of the feasibility of attaining Class B uses. MWRA's CSO Control Plan (see chapter 11) leaves minimal CSO discharges to these waters in the long-term and is generally consistent with the Class B(cso) standard. A decision to remove the variances and maintain the Class B water quality standard would require the elimination of CSO discharges. A decision to revise the water quality

standard to Class B(cso) could bring the CSO plan into compliance or could include a requirement for a higher level of CSO control.

- Biosolids Criteria: Molybdenum still remains an issue from time to time in MWRA biosolids. Less stringent criteria from EPA are under development which, if adopted by the state, would loosen the regulations for application of the pellets to livestock grazing areas.

4.08 Potential Long-Term Regulatory Considerations

Provided below is a list of potential regulatory and environmental issues, that MAY impact MWRA (and other coastal dischargers) in the future. MWRA should remain aware of these long-term issues, proactively follow scientific developments as they arise, and develop timely and appropriate recommendations (projects, costs and schedules) to maintain effective and economical system performance.

- Recreational Use Versus Regulatory Standards: As the harbor and its tributary rivers get cleaner, there may be conflicts between increased recreational use and current regulatory standards. MWRA should prepare for potentially tighter regulatory controls that may be put into place to encourage recreational use.
- Ecosystem Management: Present discharge regulations focus on limiting the discharge of pollutants. Future regulations may incorporate more concepts of ecosystem management. For example, ocean policies at both the federal and state level use this concept. This may change the way publically-owned treatment works operate.
- Emerging Contaminants: As conventional and EPA priority pollutants are better controlled, awareness among the public, the scientific and engineering, and regulatory communities has shifted to the unknown effects of emerging contaminants (also termed trace organics, endocrine disruptors, pharmaceutical and personal care products) which are ubiquitous and largely unregulated. Many of these contaminants appear to be effectively removed by secondary treatment; however, the research on many contaminants is in very early stages. MWRA can anticipate that, long-term, there will be increased regulatory pressure to measure the effectiveness of treatment on a suite of emerging contaminants and eventually there may be permit limits on additional pollutants.
- Climate Change: An especially difficult aspect of climate change is its unpredictability. What degree of climate change is occurring; what will the effects be? Issues include sea level rise, impact of more frequent and more violent storms, effects of nutrient and other discharges on the ecosystem, and ecosystem change as oceanographic patterns change.
- Green Infrastructure: Recently EPA has taken some steps to encourage the use of green infrastructure in remediation of CSO and stormwater impacts. EPA has approved green infrastructure as part of other municipalities' long-term CSO control plans and has incorporated requirements for green infrastructure into enforcement orders and penalties. It is unclear if EPA's initiative for promoting green infrastructure will affect regulatory decisions requiring higher levels of pollution control.

- Integrated Planning Approach Framework: EPA has issued a draft “Integrated Planning Approach Framework” to allow municipalities to balance various Clean Water Act requirements to address the most pressing environmental and public health issues first, which may affect how MWRA member communities address stormwater vs. SSOs vs. green infrastructure.
- MassDEP Primacy for Clean Water Act Programs: It is possible that the state environmental agencies may apply for federal authorization to administer its own Clean Water Act Programs and NPDES permitting. This may lead to higher permitting fees for MWRA, as EPA does not charge fees for permit writing and administration.

4.09 Interfacing With Regulators - MWRA’s Environmental Quality Department

MWRA’s Environmental Quality Department (ENQUAD) plays a key role in the implementation of Clean Water Act regulations. ENQUAD staff coordinate the negotiation of permits with state and federal regulators. The Department implements the administrative components of permit reporting for DITP and related CSO facilities, the Clinton AWWTP, stormwater permitting; as well as ambient monitoring of Boston Harbor, its tributary rivers, and Massachusetts Bay. In addition, environmental monitoring overseen by ENQUAD is linked to the implementation of changes in MWRA operations through MWRA’s Contingency Plan, which is incorporated into DITP’s NPDES permit. The Contingency Plan establishes a framework for evaluating the results of environmental monitoring and using those results to assess if MWRA discharges are, or are not, affecting the environment.

MWRA’s ENQUAD and Department of Laboratory Services staff (and consultants) implement an extensive environmental monitoring program in Boston Harbor and Massachusetts Bay, sampling the water column, sediments, and fish and shellfish. ENQUAD and Department of Laboratory Services also implement environmental monitoring of CSO impacts on the Charles and Alewife-Mystic Rivers as part of the CSO variance requirements. Staff manage, analyze, and report on data from MWRA facilities and from state environmental agencies, universities, and consultants. Reports are submitted to state and federal regulatory agencies, the Outfall Monitoring Science Advisory Panel, and numerous other individuals and organizations.

Data from these monitoring projects are used by state and federal regulatory agencies in developing regulatory requirements, TMDLs, and assessing whether water bodies are impaired. Because regulatory changes are often (ideally) based on science and engineering, professional environmental scientists and engineers within ENQUAD are frequently called upon by local, state, and federal agencies to advise on the development and implementation of water quality regulations and also to advise on the design and interpretation of water quality studies. ENQUAD maintains an extensive amount of data on Boston Harbor and Massachusetts Bay available at www.mwra.com.

ENQUAD reports to the Deputy Chief Operating Officer for Programs, Policy and Planning in the Operations Division. ENQUAD has 17 staff and an annual budget in the FY13 CEB of \$3.0 million. Contracted Professional Services accounts for \$1.5 million of the annual budget.

CHAPTER 5

WASTEWATER FLOW AND QUALITY TO THE DEER ISLAND TREATMENT PLANT

5.01 Chapter Summary

MWRA has reviewed planning parameters including water use trends, projected population, employment growth, sewer system build-out, potential for sewer system expansion, projected wastewater generation, and potential wastewater quality changes within the MWRA sewer service area. For the Master Plan period, MWRA projects minimal change in future wastewater flow and quality tributary to Deer Island Treatment Plant (DITP). The bullets below provide a summary of the conclusions outlined in this Chapter:

- Future population and employment growth in the MWRA sewer service area is projected to be modest. The Metropolitan Area Planning Council (MAPC) projects a population increase of 222,202 between 2010 and 2035 and an employment increase of 128,614. Using performance measures and water forecast methodologies of the Massachusetts Water Resources Commission for residential and non-residential growth, these increases in population and employment would result in a projected increase of up to 20 mgd (6 percent increase) of wastewater generation from 2010 through 2035, if water withdrawn is used as a proxy for wastewater and standard performance measures are assumed.
- Residential per capita consumption in the MWRA service area is less than the 65 residential gallons per capita per day performance measure commonly used in water supply forecasts in Massachusetts. In addition, not all water withdrawn is discharged as wastewater. For these reasons, the Wastewater System Master Plan's projected increase of up to 20 mgd of sanitary flow is extremely conservative.
- MWRA admission criteria for sewer system expansion (including requirements for inflow reductions) are stringent; therefore, MWRA expects no net increase in future wastewater flow to DITP from system growth outside the existing sewer service area. Any increase in sanitary flow may partially be offset by reductions in infiltration/inflow (I/I) from continued regional sewer system rehabilitation and reductions in stormwater contributions from combined sewer areas due to separation. The result of all project impacts on wastewater flow during the Master Planning period is estimated to be a minimal net future increase in total wastewater flow to DITP.
- MWRA projects the future DITP average dry day wastewater flow (through 2035) will remain below: (1) the 436 mgd National Pollution Discharge Elimination System (NPDES) permit limit for dry day flow; (2) the 354 mgd used for DITP secondary treatment design (1994 Design Package 29); and (3) the 480 mgd used as the initial basis for DITP design year flow (1988 Secondary Treatment Facilities Plan). Therefore, MWRA anticipates no impact on DITP due to wastewater flow increases in the service area through 2035.

- For flow tributary to DITP, no wastewater quality parameters are anticipated to change significantly for the near future. The need for capital projects to address wastewater quality will most likely be based on revised NPDES permit limits (as discussed in Chapter 4).

There are no existing or recommended CIP projects presented in this Chapter.

5.02 MWRA Sewer Service Area to DITP

MWRA's regional interceptor system tributary to the DITP receives flow from 43 member sewer communities (locally-owned collection systems) covering an area of about 518 square miles. The regional system serves about 2.2 million people, including the City of Boston and surrounding metropolitan area. About 95 percent of the service area is sewered. Figure 5-1 shows the MWRA sewer service area and the wastewater collection system. All flow from the service area is tributary to MWRA's DITP. The regional collection system encompasses about 274 miles of MWRA-owned sewer pipelines, 5200 miles of publicly-owned community sewers, and 5000+ miles of private sewer service connections. Most of the service area (93 percent) is served by separate sanitary and storm drainage systems. However, portions of five communities (Boston, Brookline, Cambridge, Chelsea, and Somerville) utilize combined sewers that account for seven percent of the sewer service area.

Community wastewater discharges into the regional collection system are subject to MWRA's Sewer Use Regulations (360 CMR 10.000) which govern the discharge of sewage, drainage, substances, and wastes into any sewer under the control of MWRA, or into any sewer tributary thereto. MWRA's Sewer Use Regulations are intended to protect the public health, safety and welfare, and the environment, and ensure proper and safe operation of the Authority's wastewater treatment facilities by regulating the direct and indirect discharge of wastewater and pollutants to the MWRA's sewerage system. MWRA's Sewer Use Regulations (online at: www.mwra.com) include general requirements and specific prohibitions to minimize infiltration and inflow and regulate the quality of wastewater discharged into the regional collection system. Details on MWRA's industrial permitting and pretreatment program and a review of wastewater quality to DITP are presented in Section 5.07.

FIGURE 5-1
Sewer System Location Plan

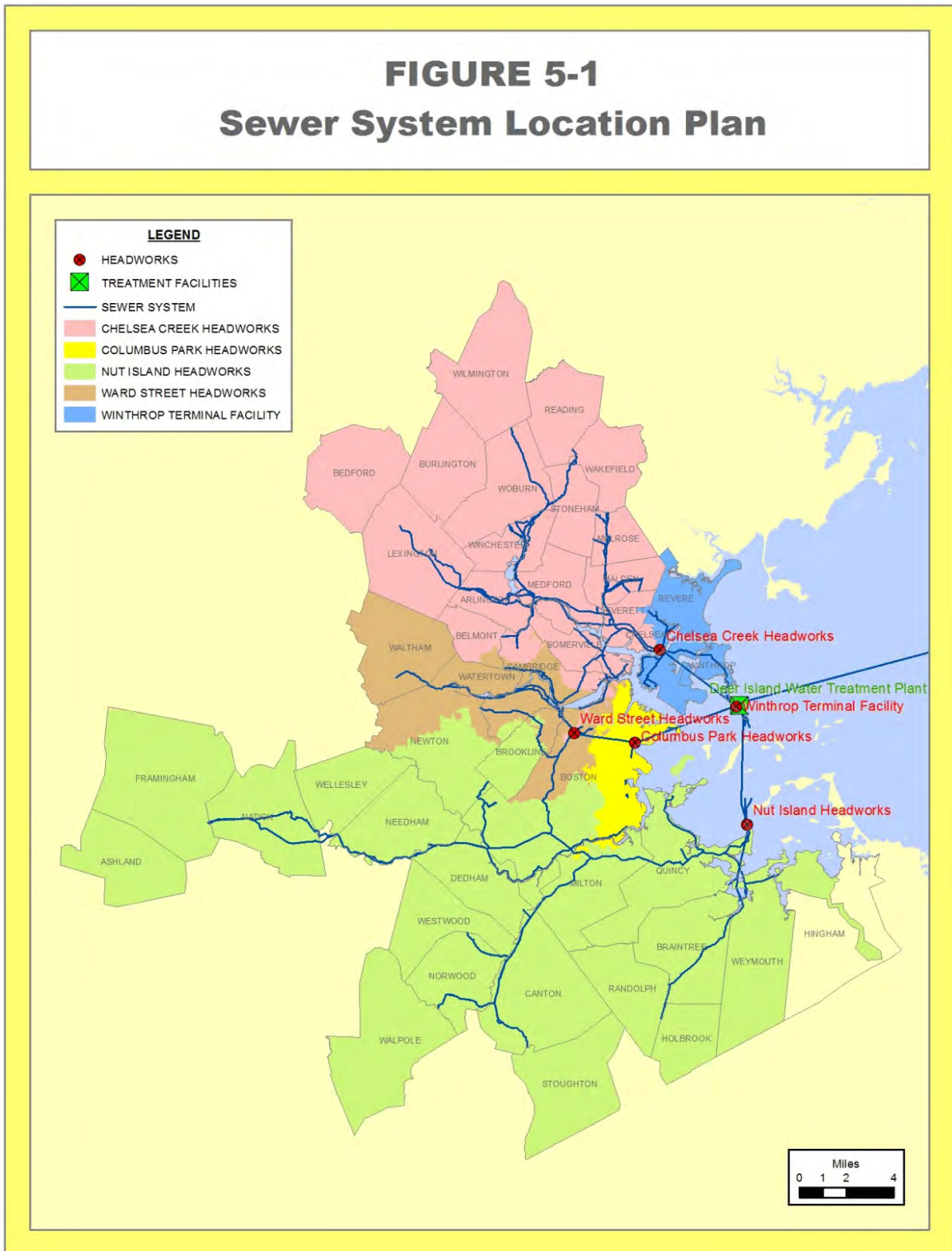

5.03 NPDES Permit for DITP

As of July 2013, MWRA is awaiting a renewal of its NPDES permit for DITP. The current permit, which expired in 2005, has been administratively continued (the provisions of the existing permit remain in force but cannot be modified) while a new permit is being prepared by EPA. Future regulatory requirements and potential changes to the NPDES permit may impact MWRA's recommended capital projects (see Chapter 4 - Wastewater Regulatory Framework). Over the Master Plan period, MWRA expects changes in regulatory requirements related to wastewater flow and quality to have more significant impact on capital project needs than actual changes in future wastewater flow and quality tributary to DITP.

MWRA's NPDES permit requires the Authority to maintain dry day wastewater flow to DITP below 436 mgd (see discussion in Section 5.06). Two reports that address wastewater flow (both submitted annually before September 1) are required under the DITP NPDES Permit: (1) Summary Report on MWRA's Demand Management Program, which is intended to reduce the sanitary component of wastewater flow; and (2) an Annual Infiltration/Inflow (I/I) Reduction Report that details metered wastewater flows, flow components, and regional efforts to reduce I/I.

MWRA's Environmental Quality Department (ENQUAD) develops a detailed NPDES Compliance Summary Report at the end of each Fiscal Year. These reports are an excellent resource for DITP influent and effluent flow and load data and have been used as a reference for this Chapter.

5.04 Review of Wastewater Flow to DITP

Wastewater average daily flow to DITP for the last 24 calendar years (CY89 through CY12) and corresponding annual rainfall recorded at the NOAA rain gauge at Boston Logan Airport are listed in Table 5-1. Prior to CY99, MWRA's South collection system was not tributary to DITP and plant flow data from both DITP and the former Nut Island Treatment Plant were combined to derive the total system flow.

Wastewater is comprised of three separate flow components: sanitary flow, groundwater infiltration, and stormwater inflow. Sanitary flow includes all residential, commercial, institutional, municipal, and industrial sewage, but specifically excludes infiltration and inflow (I/I). I/I is groundwater and rainwater that enter the sewer systems of both MWRA and its member communities through a variety of defects. In addition, five MWRA member communities (Boston, Brookline, Cambridge, Chelsea, and Somerville) have portions of the locally-owned collection systems that are constructed as combined sewers. The volume of wastewater discharged by member communities into MWRA's interceptors is significantly influenced by seasonal and wet weather conditions. About half of the annual flow treated at DITP is sanitary flow and the remaining half is stormwater from combined sewers and I/I that enters the regional sewer system. Potential future change to the sanitary component of wastewater flow to DITP is detailed in Section 5.05. Flows from combined sewers and I/I are further discussed below.

**TABLE 5-1
DITP Flow Data and Rainfall**

Calendar Year	Wastewater Average Daily Flow (mgd)	Logan Annual Rainfall (in)
1989	410	42.4
1990	411	46.5
1991	387	42.3
1992	371	43.7
1993	376	43.2
1994	382	47.6
1995	338	35.1
1996	426	52.7
1997	353	30.4
1998	412	53.7
1999	344	37.9
2000	362	45.6
2001	346	30.7
2002	341	41.1
2003	382	44.4
2004	356	44.6
2005	402	43.7
2006	380	52.8
2007	330	39.5
2008	380	54.5
2009	339	43.5
2010	346	49.7
2011	369	52.4
2012	287	36.7

24 Year Average 368 43.9

Last 5 Year Average
(CY08-CY12) 344 47.4

High levels of I/I and stormwater from combined sewers consume capacity in the collection system that would otherwise be available to transport sanitary flow. MWRA’s efforts to rehabilitate the MWRA-owned collection system (and reduce I/I) are detailed in Chapter 9 – Collection System Sewers. MWRA’s projects on combined sewers are detailed in Chapter 11 – Combined Sewer Overflow Control Plan. MWRA’s Regional I/I Reduction Plan and efforts to reduce I/I in locally-owned collection systems tributary to DITP are detailed in Chapter 15 – MWRA Financial Assistance For Community-Owned Collection Systems. Continued rehabilitation of the regional collection system is intended to at least offset ongoing collection system deterioration to prevent a net increase in regional I/I. In the long-term, continued system

rehabilitation and separation of combined sewers may result in lower I/I and stormwater flows in the sewer system, which will offset, to some extent, potential future increases in sanitary flow.

Long-term metering records are analyzed to monitor regional wastewater flow trends. Figure 5-2 provides a graph of long-term (24 years of data from Table 5-1) regional flow data for annual average daily wastewater flow and annual rainfall recorded at the NOAA rain gauge at Boston Logan Airport. The 24-year average daily wastewater flow is 368 mgd and the average annual rainfall over the 24-year period is 43.9 inches. Comparing the same data for the last five years (CY08-12), the average daily wastewater flow is down to 344 mgd; however, the average annual rainfall has increased a small amount to 47.4 inches. During the 24-year period of record, the regional wastewater flow trend is modestly declining while the annual rainfall trend is modestly increasing. The declining wastewater flow is more evident in Figure 5-3 which displays the five-year running averages (flow and rainfall) as a means of smoothing the annual variability in the data.

The data displayed in Table 5-1 and Figure 5-2 shows that annual wastewater flow to DITP has varied dramatically (by over 100 mgd) from a low of 287 mgd (in CY12) to a high of 426 mgd (in CY96). This variability in annual average flow (up to 25 percent of the long-term average) is influenced by many factors, including:

- Change in volume, intensity, and duration of rainfall events that increase or decrease stormwater entering combined sewers and I/I entering the regional collection system;
- DITP upgrades and regional sewer interceptor and pumping upgrades that increase flow transmission and treatment capacity;
- Regional combined sewer overflow and system optimizations that increase the capture and treatment of combined flow; offset by combined sewer overflow separation projects that decrease stormwater tributary to DITP;
- I/I rehabilitation projects that reduce wastewater flow in a local sewer subsystem; however, these projects may produce a lower net flow reduction at the end of the collection system because of offsetting increases from other I/I sources;
- Increase in service area sewered population leading to an increase in wastewater flow; and,
- Decrease in *per capita* water use (portion returned to the sewer system) due to installation of low-flow plumbing fixtures/appliances and conservation trends leading to a decrease in wastewater flow.

FIGURE 5-2
MWRA Long-Term Regional Flow Data
NOAA Annual Rainfall at Logan Airport

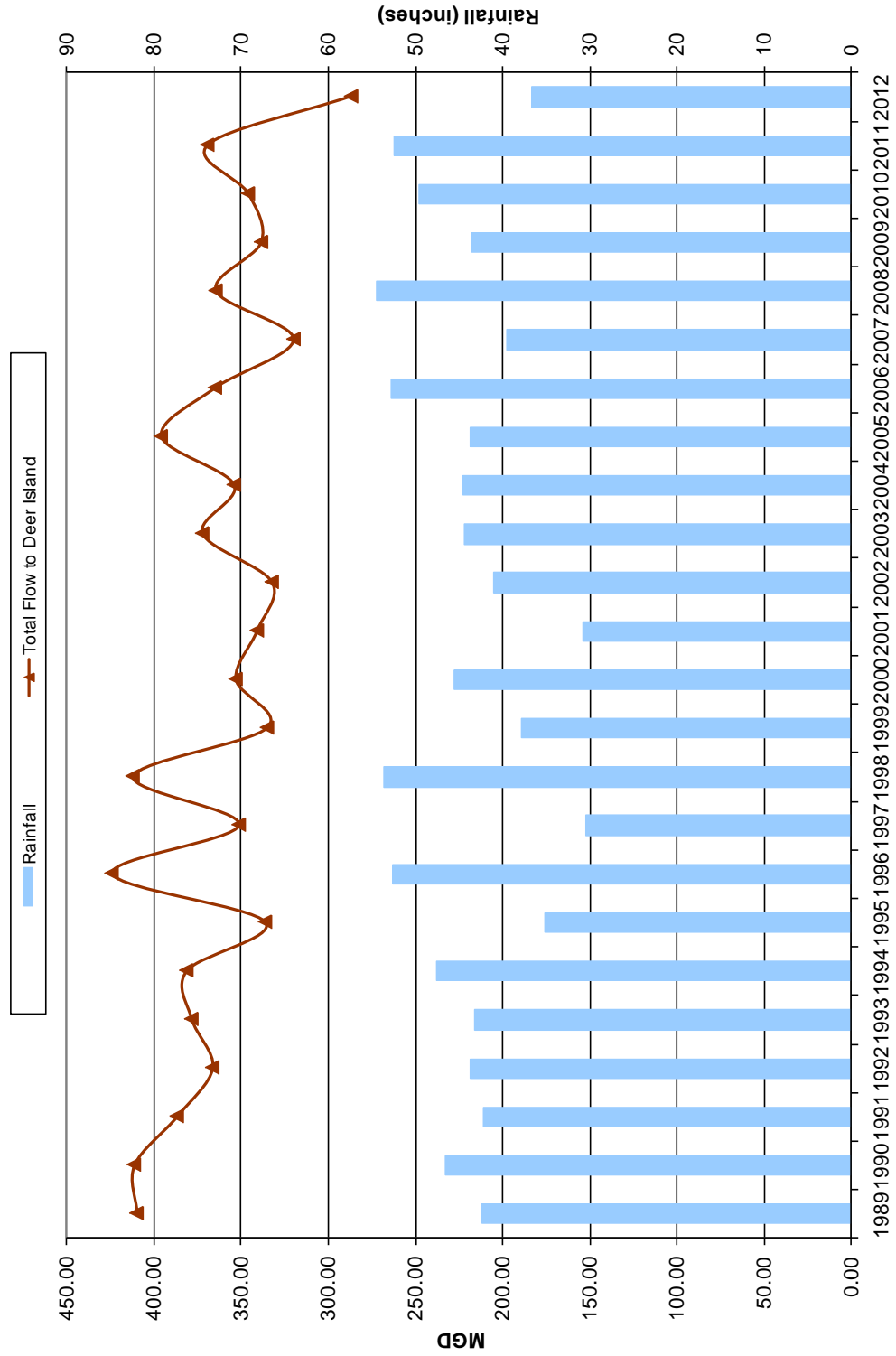
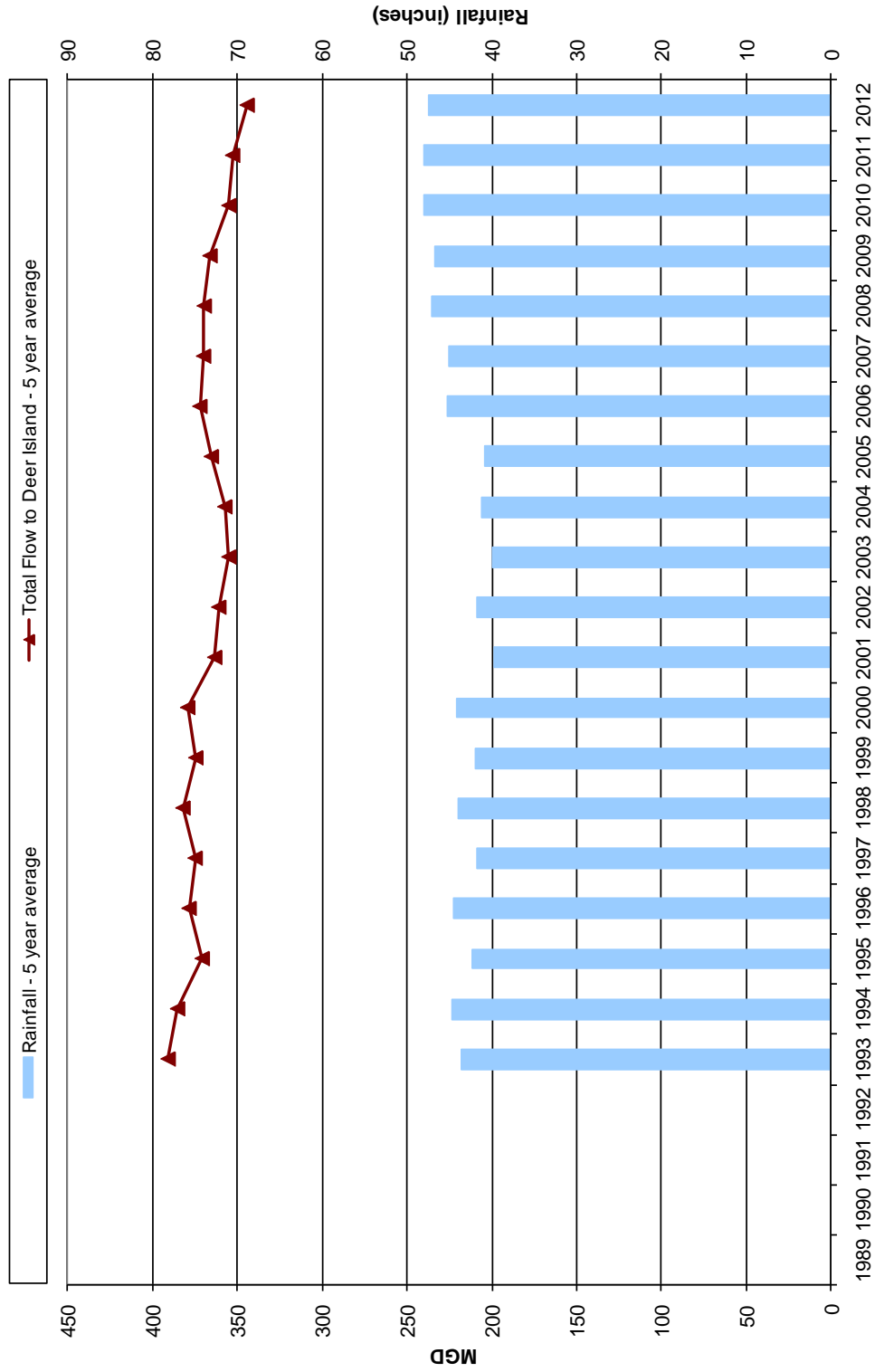

FIGURE 5-3
MWRA Long-Term Regional Flow Data
5-year Running Averages
5 year running NOAA Rainfall Average at Logan Airport



5.05 Potential Future Increase in Sanitary Flow to DITP

There are three ways the sanitary component of wastewater flow may potentially increase in MWRA’s sewer service area: (1) increase in water use (per capita), (2) increase in sewer population and/or employment, and (3) expansion of the regional boundary of the sewer service area. The potential for such increases are discussed below.

Water Use in the MWRA Sewer Service Area

MWRA water supply and demand are fully detailed in Chapter 4 of the 2013 Water System Master Plan. MWRA continues to implement effective water demand management and water conservation policies and programs for the MWRA-owned and community-owned water distribution systems. The effectiveness of MWRA’s conservation efforts over the past 25 years is demonstrated by the fact that baseline water demand (water withdrawal from MWRA reservoirs) has been dramatically reduced from 1985 levels, continues to moderately decline, and is comfortably below the system’s safe yield of 300 mgd (see Figure 5-4).

FIGURE 5-4

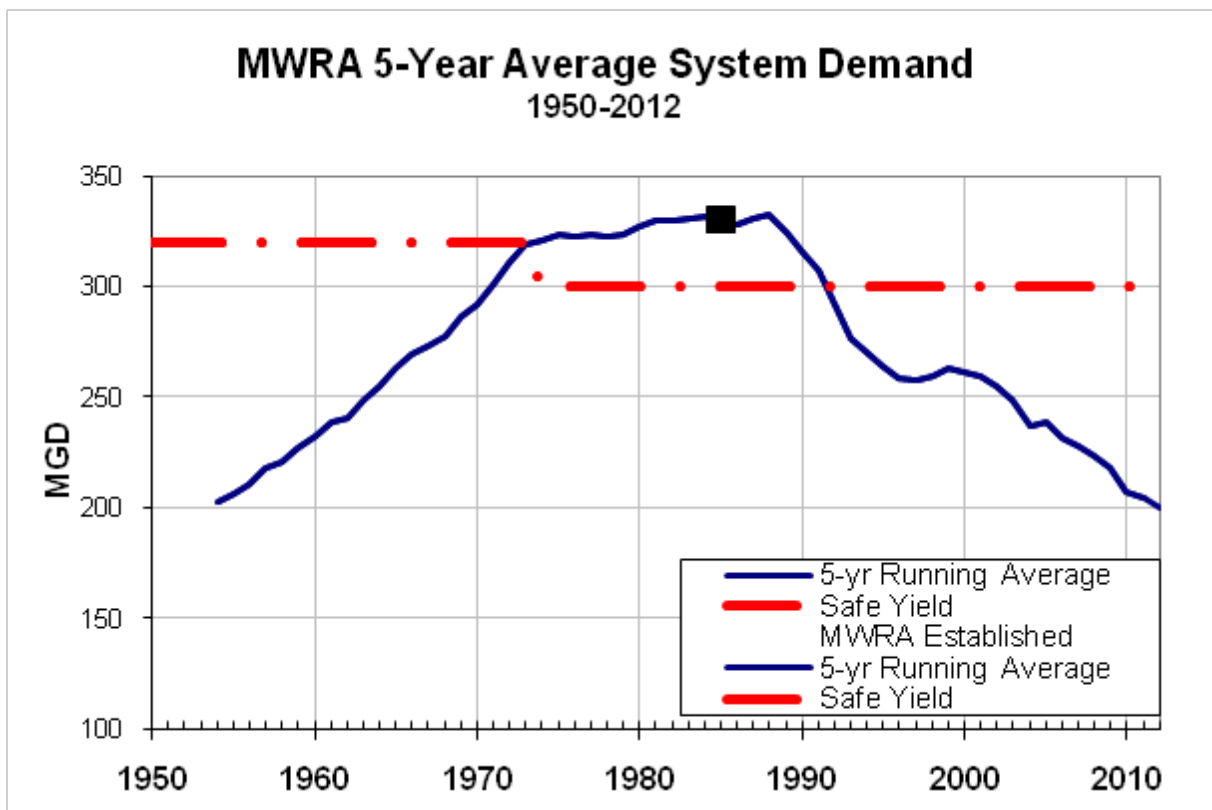

Regional actions that have helped reduce water demand in the MWRA service area include:

- Leak detection surveys of MWRA distribution mains and subsequent leak repairs;
- Leak detection surveys of member community distribution mains and subsequent leak repairs (required at least every two years via 360 CMR 12.00 – Leak Detection Regulations);
- Improved MWRA wholesale water metering for member community purchases;
- Plumbing code revisions (including 1.6 or less gallon per flush toilets);
- MWRA’s distribution of free low-flow fixtures (showerheads, faucet aerators, toilet dams);
- MWRA’s distribution of free water conservation literature;
- MWRA’s school education program that provides classroom presentations and science-based curriculum to promote water conservation awareness for young people;
- MWRA’s \$432 million interest-free loan program (10-year repayment) designed to fund local community water system rehabilitation projects (targeting unlined water mains, water tank rehabilitation, water metering system upgrades, etc.); and,
- Significant water and sewer rate increases.

Given the focus on conservation in state water policy coupled with regional and national trends of declining residential demand, per capita water use is likely to decrease. For the Wastewater System Master Plan, it will be assumed (conservatively) that sanitary flow (generated from per capita water use in the sewer service area) will remain at or below the current state performance standard of 65 residential gallons per capita per day (RGPCD), and will not increase over the planning period.

Sewered Population and Employment in the MWRA Sewer Service Area

The baseline (2010 census) MWRA sewer service area total population is 2.19 million people (see Table 5-2). Of this total, about 80,000 (4 percent) are currently unsewered residents served by on-site septic systems, and about 2.11 million (96 percent) are connected to the regional sewer system. In February 2010, MAPC adopted population projections to the year 2035. The MAPC planning area encompassed all communities that are part of the MWRA sewer service area (as well as a number of other communities). MAPC projections reflect totals for population and employment issued by the Massachusetts Department of Transportation (MDOT), Office of Transportation Planning. The population projections also incorporate data from MAPC’s development data base for residential and commercial developments recently completed, constructed, or planned. Communities collaborated on and reviewed the population projections, which underwent public review prior to finalization. As noted on Table 5-2, population growth between 2010 and 2035 for the MWRA sewer service area is projected to increase by 222,202 persons, an increase of 10 percent.

**TABLE 5-2
Population Data**

MWRA SEWER AREA		
Community	Baseline Total Population (1)	Projected Total Population for 2035 (2)
Arlington	42,844	42,173
Ashland	16,593	19,153
Bedford	13,320	14,373
Belmont	24,729	25,444
BWSC	617,595	727,719
Braintree	35,744	38,085
Brookline	58,732	59,499
Burlington	24,498	27,392
Cambridge	105,162	123,300
Canton	21,561	23,056
Chelsea	35,177	43,905
Dedham	24,729	27,039
Everett	41,667	40,237
Framingham	68,318	71,288
Hingham	7,475	9,104
Holbrook	10,791	11,204
Lexington	31,394	32,545
Malden	59,450	61,449
Medford	56,173	57,914
Melrose	26,983	28,596
Milton	27,003	27,000
Natick	33,006	36,125
Needham	28,886	30,627
Newton	85,146	86,303
Norwood	28,602	29,728
Quincy	92,271	95,563
Randolph	32,112	33,618
Reading	24,747	25,687
Revere	51,755	57,167
Somerville	75,754	88,045
Stoneham	21,437	23,716
Stoughton	26,962	29,927
Wakefield	24,932	27,253
Walpole	24,070	24,580
Waltham	60,632	63,049
Watertown	31,915	33,641
Wellesley	27,982	28,301
Westwood	14,618	16,553
Weymouth	53,743	64,343
Wilmington	22,235	24,514
Winchester	21,374	22,475
Winthrop	17,497	17,911
Woburn	38,120	40,335
TOTAL	2,187,734	2,409,936

Total projected increase in population 222,202

Estimated Increase in wastewater generation 14.43 mgd

(1) 2010 U.S. Census Data
(2) Metropolitan Area Planning Council/DOT projections

**TABLE 5-3
Employment Data**

MWRA SEWER AREA		
Community	Baseline Employment (1)	Projected Employment for 2035 (1)
Arlington	7,797	8,035
Ashland	4,966	4,962
Bedford	21,561	22,697
Belmont	6,263	6,437
BWSC	545,079	603,393
Braintree	26,221	27,207
Brookline	17,164	17,584
Burlington	37,223	38,104
Cambridge	103,015	119,953
Canton	23,146	23,316
Chelsea	13,393	14,973
Dedham	14,413	14,719
Everett	12,771	12,894
Framingham	43,809	46,829
Hingham	11,790	12,233
Holbrook	2,628	2,783
Lexington	19,287	21,696
Malden	15,031	15,133
Medford	17,906	19,237
Melrose	6,273	6,468
Milton	4,998	4,990
Natick	24,218	25,401
Needham	20,260	21,033
Newton	47,779	49,962
Norwood	23,871	25,126
Quincy	48,046	51,860
Randolph	7,734	8,429
Reading	6,417	6,649
Revere	8,873	10,031
Somerville	20,435	35,564
Stoneham	7,757	8,252
Stoughton	12,691	13,444
Wakefield	14,091	14,054
Walpole	10,376	10,308
Waltham	54,248	55,241
Watertown	18,334	19,072
Wellesley	16,735	17,629
Westwood	9,796	12,691
Weymouth	18,275	22,652
Wilmington	18,939	18,162
Winchester	8,409	8,805
Winthrop	1,885	1,898
Woburn	38,887	41,498
TOTAL	1,392,790	1,521,404

Total projected increase in employment 128,614

Estimated Increase in wastewater generation 5.87 mgd

(1) MAPC Data and Projections

A residential water consumption rate of 65 RGPCD is assumed as this is the state performance standard and is the value used in the water forecast methodology of the Massachusetts Water Resources Commission. At 65 RGPCD for the projected 222,202 person population increase, a residential sanitary flow increase of about 14.4 mgd is estimated. This projection is at the high end (conservative) because (1) some water consumed will not be returned to the sewer system as wastewater; and (2) more than half of the regional population growth is projected to occur in Boston where, over a number of years, residential consumption has trended between 42-51 RGPCD, well below the state performance standard. It is possible that some of the unsewered area in MWRA communities will become sewerred, and some of the conservatism in estimating projected wastewater generation will be offset by build-out (infilling) of the collection system.

MDOT and MAPC also projected employment growth based on growth projections by industry sector, historic state and regional employment, and sectoral trend data. Table 5-3 shows employment between 2010 and 2035 for the MWRA sewer service area projected to increase by 128,614 persons. MAPC's projections for employment growth note that a large portion of the employment growth is recovery from the recent recession. MAPC also notes that employment projections for 2035 exceed 2000 employment by less than one percent.

The Water Resources Commission (WRC) Water Needs Forecast methodology was used to project water use and resulting wastewater generation associated with increased employment. This methodology multiplies the baseline non-residential average daily demand by percent change in employment to derive the new water demand (and for the purpose of this analysis, the new wastewater demand) due to employment growth. The WRC methodology is arguably conservative and inflates the gallons used per employee, as the non-residential demand includes not only commercial, industrial, and other uses; it also includes municipal water use. Municipal water use does not distinguish between water used by municipal employees and water used for schools, municipal buildings, non profits such as churches, and irrigation uses. Based on WRC's methodology, water use in the MWRA service area is approximately 45 gallons per employee. Using the employment forecast through 2035 (an increase of 128,614 employees) and an estimate of 45 gallons per employee per day, there would be an additional 5.8 mgd of commercial/industrial/institutional wastewater generation by 2035.

In summary, future population and employment growth is projected to be modest. The projected population increase of 222,202 persons and employment increase of 128,614 persons results in a projected increase of up to 20 mgd of sanitary wastewater flow generation from 2010 through 2035. The projected 20 mgd represents a potential 6 percent increase over the current 360 mgd average daily wastewater flow to DITP over the last five years.

Boundary of MWRA Sewer Service Area and Expansion Policies

The MWRA sewer service area was defined in the Enabling Act that created the Authority, Chapter 372 of the Acts of 1984. Since 1984, there have been no new member communities added to the MWRA sewer system. Some communities adjacent to the MWRA sewer service area are currently served by community or regional wastewater treatment plants, whereas a number are served by onsite septic systems. At the present time, the demand for sewer expansion to communities (or large portions of communities) outside the service area is low. None of the communities immediately adjacent to the existing service area have expressed strong interest in becoming MWRA member sewer communities. MWRA's sewer expansion policies are as follows:

- **OP.04, Sewer Connections Serving Property Partially Located in a Non-MWRA Community.** This policy applies to persons seeking MWRA sewer services for buildings and structures partially within and partially outside MWRA's service area. It is also known as the "Sewer Straddle" policy.
- **OP.11, Admission of New Community to MWRA Sewer System and Other Requests for Sewer Service to Locations Outside MWRA Sewer Service Area.** This policy applies to communities seeking admission to the MWRA sewer system and to all parties seeking sewer services for locations outside the MWRA service area.

MWRA receives occasional requests to extend its sewer service to individual projects, institutions, businesses, and/or homes in non-sewered areas in communities adjacent to MWRA. There have also been inquiries regarding the formation of new sewer districts to be served by MWRA. Often initial inquiries do not result in a formal application to MWRA, and expansions of the MWRA sewer service area are infrequent. All individual applicants that have successfully joined the MWRA sewer service area under the expansion policies collectively total less than 1.0 mgd of additional sanitary flow, prior to accounting for required inflow offsets (as discussed below). Unlike the MWRA waterworks system, where there is more than ample capacity to serve new water customers, the wastewater collection system is constrained.

The Enabling Act forms the foundation of the expansion policies and the Act requires that MWRA must find that the safe capacity of the sewer system as extended will be sufficient to meet ordinary wet weather demands and that all feasible actions have been taken by any local body to which the system is extended to minimize infiltration and inflow. The policies detail the criteria MWRA will use to evaluate any request by a community, individual, or other entity. MWRA's admission criteria are rigorous and include requirements for inflow reductions that will more than offset new wastewater flows (four gallons of inflow removed for each gallon of new sanitary flow). Based on policy requirements, it is assumed that any future new connections from outside the sewer service area (system expansion) will result in no net increase in wastewater flow to MWRA's DITP.

5.06 Potential for Future Wastewater Flow Increases to Impact DITP

MWRA's NPDES Permit requires the Authority to maintain a 365 calendar day running average dry day wastewater flow to DITP below 436 mgd. The dry day flow is reported monthly by MWRA as part of the NPDES Operational Performance Summary. For fiscal year 2013, the 365-calendar day running average dry day flow to DITP was 272 mgd and has averaged about 302 mgd over the last five years and 313 mgd over the last fifteen years (see Table 5-4). The dry day wastewater flow has less annual variability than total wastewater flow because wet weather flow is more variable due to the impact of infiltration/inflow and stormwater (as detailed in Section 5.04).

As discussed in Section 5.05, future sanitary flows in the sewer service area could increase up to 20 mgd through 2035 as a result of population growth, employment growth, and sewer system build-out. Therefore, DITP average dry day wastewater flow through 2035 should remain well below: (1) the 436 mgd NPDES Permit limit for dry day flow; (2) the 354 mgd used for DITP secondary treatment design (1994 DP-29); and (3) the 480 mgd used as the initial basis for DITP design year flows (1988 STFP). In summary, MWRA anticipates no impact on the DITP due to potential wastewater flow increases in the service area through 2035.

TABLE 5-4
Average Dry Day Wastewater Flow to DITP

Fiscal Year	Running Dry Day Flow (mgd)
1999	307
2000	324
2001	324
2002	294
2003	330
2004	321
2005	345
2006	323
2007	332
2008	286
2009	310
2010	342
2011	283
2012	304
2013	272
Fifteen Year Average	313
Last Five Year Average (FY09-FY13)	302

5.07 Review of Wastewater Quality to DITP

MWRA samples DITP influent and effluent for a variety of characteristics including conventional wastewater parameters, nutrients, priority pollutants (metals, cyanide, pesticides/PCBs, and organic compounds), fecal coliform bacteria, and whole effluent toxicity. The NPDES permit requires effluent monitoring, with results submitted monthly to EPA and MassDEP. Influent sampling measures wastewater quality prior to treatment. MWRA's Environmental Quality Department administers the NPDES permit reporting requirements and develops a detailed NPDES Compliance Summary Report at the end of each fiscal year. These reports are an excellent resource for DITP influent and effluent flow and quality parameters (<http://www.mwra.state.ma.us/harbor/enquad/trlist.html>).

Influent to DITP is classified as a weak/medium load based on average total suspended solids (TSS) of about 200 to 250 mg/L, average total kjeldahl nitrogen (TKN) of about 30 to 35 mg/L, and average ammonia-nitrogen of about 15 to 20 mg/L. Metals and organic priority pollutant loadings in the MWRA collection system have been decreased over time through two MWRA programs: (1) the Toxic Reduction and Control Department (TRAC) industrial permitting and pretreatment program, and (2) the water supply corrosion control program. Changes in industrial loadings have also affected influent loadings, and state and MWRA programs have substantially decreased loadings of mercury to the waste stream.

Community wastewater discharges (including residential, commercial, industrial, and institutional flows) into the MWRA regional collection system are governed by MWRA's Sewer Use Regulations to protect public health, safety and welfare, and the environment, and ensure proper and safe operation of the Authority's wastewater treatment facilities by regulating the direct and indirect discharge of wastewater and pollutants to the Authority sewerage system. The Sewer Use Regulations (www.mwra.com) include general requirements and specific prohibitions to minimize infiltration and inflow and regulate the quality of wastewater discharged into the regional collection system. The MWRA Sewer Use Regulations are derived from EPA regulations (40CFR Part 403) and are implemented by MWRA's TRAC Department. The EPA regulations identify three main objectives of the National Pretreatment Program:

- Prevent the introduction of pollutants into the sanitary sewer system which will interfere with the operation of the sewer system, including worker health and safety during operation and maintenance activities, and which will interfere with MWRA's use or disposal of residuals from the treatment of sanitary sewerage;
- To prevent the introduction of pollutants which will pass through the treatment works or otherwise be incompatible with the treatment works; and,
- To improve the opportunities to recycle and reclaim municipal and industrial wastewaters and residuals.

The TRAC Department carries out the requirements of the National Pretreatment Program to meet these objectives. EPA regulations require MWRA to perform permitting, inspection, monitoring, and enforcement activities in accordance with MWRA's NPDES permits and the federal regulations. As of July 2013, the TRAC Department oversees over 1150 permitted industrial and commercial users of the sewer system, including more than 200 that meet EPA's definition of Significant Industrial User. TRAC's Industrial Pretreatment Program Annual

Report (Industrial Waste Report) documents MWRA's ongoing efforts to implement the requirements of 40 CFR Part 403, General Pretreatment Regulations.

Over the past two decades, the mix of industrial users has transitioned from heavily water dependent industries such as metal products manufacturing to much less water intensive operations such as biotechnology and pharmaceutical research and development. Water conservation measures have been instituted throughout commercial and industrial facilities, reducing the proportion of wastewater attributable to these sources over time. MWRA's most recent analysis (completed in 2000) estimated only about 3 to 4 percent of wastewater flow to DITP was discharged from permitted industrial and commercial users of the sewer system. This analysis will be reexamined when MWRA completes a reevaluation of its local limits following EPA's renewal of the Deer Island NPDES permit. The decline in traditional photo-processing and printing operations has resulted in lower discharges of heavy metals into the sewer system during the past two decades as well. However, future impacts to wastewater quality resulting from the growing universe of biotechnology and pharmaceutical research and development facilities are unknown at this time. Traditional pollutant analysis methods do not necessarily reveal all the pollutants being discharged.

MWRA continues to address hydrogen sulfide corrosion and odor issues in the regional collection system (see Chapter 9), which have been attributed to high levels of biochemical oxygen demand (BOD) and sulfates. In 1999, MWRA proceeded with a multi-faceted corrosion and odor control program, including: (1) source reduction in the form of BOD, sulfate and sulfide limits for municipal and industrial discharges; (2) treatment in the form of chemical addition and installation of biofilters at key locations and, (3) asset protection through rehabilitation of affected sewers and related structures. A 2003 Wastewater Characterization Study identified the various components in MWRA's wastewater, with hydrogen sulfide being one of the more important parameters tested. As a follow-up, a project was developed to introduce chemicals into the Framingham Extension Sewer system for hydrogen sulfide and corrosion control. Internal TV and physical inspections continue to be prioritized for affected sewers and TRAC Department staff continue to oversee the pre-treatment work of municipalities and industries in the program. Capital projects to address hydrogen sulfide corrosion and odor issues in the collection system are included as recommendations in Chapter 9.

In summary, DITP influent wastewater quality parameters are not anticipated to change significantly in the near future. However, there are potential changes to wastewater quality that may occur over the long term if the biotechnology and pharmaceutical industries grow and change. Also, there may be an increasing trend for use of drugs and medications now used in hospitals to be used at home, where TRAC programs currently have no jurisdiction. Emerging technologies (like nanotechnologies) are being used in medications, clothing, cosmetics and personal care products. Existing DITP treatment processes are expected to continue to meet NPDES permit limits. However, if new limits for emerging contaminants, nutrients, or conventional pollutants (such as pathogen indicator bacteria) are incorporated into future NPDES Permits, then there may be a need for future capital projects targeting wastewater quality to DITP. Additional current and long-term regulatory issues and potential impacts on MWRA are detailed in Chapter 4.

CHAPTER 6

DEER ISLAND TREATMENT PLANT

6.01 Chapter Summary

MWRA's Deer Island Treatment Plant (DITP) was the centerpiece of MWRA's \$3.8 billion construction program to alleviate pollution in Boston Harbor. The plant provides primary and secondary treatment of wastewater collected from approximately 2.2 million people in 43 greater Boston communities. Treated wastewater effluent is carried by a 9.4-mile, 24-foot diameter outfall tunnel and discharged into the 100-foot deep waters of Massachusetts Bay. Components of DITP include: influent pumps, primary treatment, secondary treatment, disinfection, dechlorination, the outfall tunnel, sludge digesters, odor control, and on-site power generation. Extensive monitoring of wastewater effluent and Massachusetts Bay ensures protection of the environment. DITP meets federal and state environmental standards and complies with a stringent National Pollutant Discharge Elimination System (NPDES) permit as described in Chapter 4. MWRA's Clinton Advanced Wastewater Treatment Plant is detailed separately in Chapter 14 of the Wastewater System Master Plan.

This Chapter provides details on the major equipment and processes at DITP the second largest wastewater treatment plant in the U.S. The components of DITP came on-line sequentially beginning in January 1995 with construction completed in 2001 and performance certification completed in 2002. The plant has a unique combination of treatment processes and automation. Also, the technological and engineering challenges of constructing the facility required uncommon solutions which present additional challenges in its operation, maintenance, and replacement of equipment and related support systems. Most plant equipment and structures are up to fifteen years old and in good condition. Operability of mechanical equipment and maintenance of electric and standby power systems are key elements to minimize risk of component failure, particularly during large storm events when the plant is at full capacity. Key decision making includes the cost-benefit analyses of timing the replacement of aging equipment and planning the kinds and numbers of spare parts to pre-purchase. MWRA and DITP's highly skilled and qualified staff are committed to excellence in the operation and maintenance of this valuable public asset. DITP staff have developed systems, policies, and protocols for assessing the current condition of structures and equipment and determining when to schedule the necessary level of maintenance or replacement.

The replacement asset value of the DITP is \$2.5 billion (38 percent of wastewater system asset value) and the outfall tunnel is \$530 million (8 percent of wastewater system asset value). See detail on Wastewater Infrastructure Replacement Asset Value in Section 3.07. Major DITP processes and/or facilities are detailed within the Chapter Section noted below:

- 6.05 Pumping and Preliminary Treatment;
- 6.06 Primary Wastewater Treatment;
- 6.07 Secondary Wastewater Treatment;
- 6.08 Disinfection and Dechlorination;

- 6.09 Outfall Tunnel and Effluent Discharge;
- 6.10 Residuals Processing;
- 6.11 Electrical Generation and Distribution;
- 6.12 Odor Control Facilities; and,
- 6.13 Additional Support Systems.

For the Deer Island Treatment Plant, \$1,146.52 million in projects is identified in the 40-year Master Plan timeframe (FY14-53). Fifty projects (\$456.82 million) are programmed in the FY14 CIP. Forty-seven additional projects (\$689.7 million) are recommended for inclusion in future CIPs. Section 6.14 – Summary of Existing and Recommended Capital Projects includes a consolidated list of all projects recommended in this Chapter. Existing DITP treatment processes are expected to continue to meet NPDES permit flow and wastewater quality parameters. However, if new limits for emerging contaminants, nutrients, or conventional pollutants are incorporated into future NPDES permits, additional future capital projects for DITP beyond those outlined in this chapter may be required. Additional current and long-term regulatory issues and potential impacts on MWRA are detailed in Chapter 4.

Near-term (FY14-18):

- \$188.385 million is programmed in the FY14 CIP:
 - \$3.923 million to provide as-needed design services and/or construction support;
 - \$5.0 million to provide additional as-needed design services (not yet awarded);
 - \$1.8 million to begin South System Pump Station Variable Frequency Drive Replacement;
 - \$18.212 million for North Main Pump Station Variable Frequency Drive Replacement;
 - \$6.086 million for North Main Pump Station Motor Control Center Replacement;
 - \$10.0 million for North Main Pump Station Butterfly Valve and Winthrop Terminal Facility Plug Valve Replacement;
 - \$4.796 million for Winthrop Terminal Facility and Miscellaneous Variable Frequency Drive Replacements;
 - \$2.333 million to begin Future Miscellaneous Variable Frequency Drive Replacements;
 - \$2.699 million to continue Expansion Joint, Clarifier, and Retaining Wall Repairs;
 - \$71,000 to continue Clarifier Repairs for Replacement of Water Flushing Lines;
 - \$20.0 million for Clarifier Scum Skimmer (Tip Tube) Replacement;
 - \$3.417 million to begin Clarifier Rehabilitation Phase 2 Work;
 - \$4.944 million to begin Ancillary Modifications #4 for the Cryogenics and Odor Control Facilities;
 - \$1.1 million for Cryogenics Chillers Replacement;
 - \$6.9 million for Cryogenics Plant Equipment Replacement;
 - \$10.558 million for Sodium Hypochlorite Pipe Replacement;
 - \$2.446 million to begin Chemical Pipe Replacement;
 - \$1.667 million to begin Sodium Hypochlorite Tank Rehabilitation;
 - \$2.543 million for Sodium Bisulfite Tank Rehabilitation;
 - \$5.786 million for Gravity Thickener Rehabilitation Improvements;
 - \$498,000 to continue Gravity Thickener Center Column Replacement;
 - \$3.868 million to continue Centrifuge Back-drive Replacement;

- \$520,000 to begin Centrifuge Replacements;
 - \$542,000 to continue Digester Modules 1 and 2 Pipe Replacement;
 - \$1.875 million to begin Digester and Storage Tank Rehabilitation;
 - \$1.2 million for Dystor Tank Membrane Replacements;
 - 5.474 million for Digester Sludge Pump Replacement;
 - \$3.0 million to continue Power System Improvements;
 - \$800,000 for Thermal Power Plant Fuel System Modifications;
 - \$1.0 million for Thermal Power Plant Boiler Control Replacement;
 - \$338,000 to begin LOCAT Scrubber Replacement;
 - \$3.333 million to begin Combustion Turbine Generator Rebuilds;
 - \$12.062 million for Electrical Equipment Upgrades Phase 4;
 - \$799,000 to begin Electrical Equipment Upgrades Phase 5;
 - \$2.651 million to begin Switchgear Replacements;
 - \$2.25 million to begin Switchgear Replacements Phase 2;
 - \$13.793 million to begin HVAC Equipment Replacement;
 - \$90,000 to begin DITP Process Instrumentation Control System (PICS) Replacement;
 - \$16.758 million to begin Fire Alarm System Replacement;
 - \$1.272 million to begin Eastern Seawall Repairs;
 - \$750,000 to begin Barge Berth and/or Pier Facilities;
 - \$1.156 million to complete Roof Replacement Phase 3; and,
 - \$75,000 to complete the Document Format Conversion project.
- \$27.25 million in needs is identified for FY14-18 and recommended for inclusion in future CIPs:
 - \$3.0 million for Future South System Pump Station Shaft and Motor Replacements;
 - \$20.0 million for Cross-harbor Cable Dredging Construction;
 - \$1.5 million to begin Steam Turbine Generator (STG) Replacement;
 - \$500,000 for Leak Protection System Upgrades;
 - \$250,000 for Cathodic Protection Testing; and,
 - \$2.0 million for Personnel Dock Rehabilitation Construction.

Mid-term (FY19-23):

- \$221.679 million is currently programmed in the FY14 CIP:
 - \$10.0 million to provide additional as-needed design services (not yet awarded);
 - \$25.0 million to provide a placeholder budget for Future DI Equipment Replacement;
 - \$22.2 million to complete South System Pump Station Variable Frequency Drive Replacement;
 - \$2.9 million for South System Pump Station Pump Lube System Replacement;
 - \$7.183 million to begin Future North Main Pump Station Variable Frequency Drive Replacements;
 - \$3.0 million for North Main Pump Station Harmonic Filter Replacement;
 - \$4.334 million to complete Future Miscellaneous Variable Frequency Drive Replacements;
 - \$26.583 million to complete Clarifier Rehabilitation Phase 2 Work;
 - \$10.18 million to complete Ancillary Modifications #4 for the Cryogenics and Odor Control Facilities;
 - \$311,000 to complete Chemical Pipe Replacement;

- \$8.333 million to complete Sodium Hypochlorite Tank Rehabilitation;
 - \$4.68 million to continue Centrifuge Replacements;
 - \$22.875 million to complete Digester and Storage Tank Rehabilitation;
 - \$1.515 million for Digester Gas Flare #4 project;
 - \$4.832 million to begin LOCAT Scrubber Replacement;
 - \$2.667 million to complete Combustion Turbine Generator (CTG) Rebuilds;
 - \$15.974 million to continue Electrical Equipment Upgrades Phase 5;
 - \$3.146 million to complete Switchgear Replacements;
 - \$18.25 million to complete Switchgear Replacements Phase 2;
 - \$6.807 million to complete HVAC Equipment Replacement;
 - \$8.0 million for DITP Process Instrumentation Control System (PICS) Distributed Process Units (DPU) Replacement;
 - \$5.4 million for DITP Process Instrumentation Control System (PICS) Replacement;
 - \$3.142 million to complete Fire Alarm System Replacement;
 - \$2.902 million to complete Eastern Seawall Repairs; and,
 - \$1.515 million to complete Barge Berth and/or Pier Facilities.
- \$15.7 million in needs is identified for FY19-23 and recommended for inclusion in future CIPs:
 - \$3.0 million for Future South System Pump Station Shaft and/or Motor Replacements;
 - \$600,000 for Enterprise Engine Removal;
 - \$1.5 million for Future Cryogenics Plant Cooling Tower and Related Equipment Replacements;
 - \$3.0 million for Future Outfall Inspections;
 - \$1.5 million for Future Transformer Replacements;
 - \$2.0 million to complete Steam Turbine Generator (STG) Replacement;
 - \$2.0 million for Future Heat Loop Pipe Replacement; and,
 - \$2.1 million for Future Electrical Equipment Upgrades.

Long-term (FY24-33 and FY34-53):

- \$46.756 million is currently programmed in the FY14 CIP:
 - \$6.05 million to provide additional as-needed design services (not yet awarded); and,
 - \$14.917 million to complete Future North Main Pump Station Variable Frequency Drive Replacements;
 - \$15.6 million to complete Centrifuge Replacements;
 - \$1.8 million for Dystor Tank Membrane Replacements;
 - \$6.389 million to complete Electrical Equipment Upgrades Phase 5; and,
 - \$2.0 million for East/West Odor Control Air Handler Replacement.
- 646.75 million in needs is identified for FY24-33 and FY34-53 and recommended for inclusion in future CIPs:
 - \$56.0 million to provide Future As-needed Design Services;
 - \$60.0 million to provide Future DI Equipment Replacement;
 - \$72.0 million for Future South System Pump Station Variable Frequency Drive Replacements;
 - \$6.0 million for Future South System Pump Station Shaft and Motor Replacements;

- \$44.0 million for Future North Main Pump Station Variable Frequency Drive Replacements;
- \$12.0 million for Future North Main Pump Station Motor Replacements;
- \$20.0 million for Future North Main Pump Station Motor Control Center Replacement;
- \$9.0 million for Future Winthrop Terminal Facility Variable Frequency Drive Replacements;
- \$21.0 million for Future Miscellaneous Variable Frequency Drive Replacements;
- \$6.0 million for Future Winthrop Terminal Facility Shaft and Motor Replacements;
- \$6.0 million for Future Cryogenics Plant Equipment Replacement;
- \$1.5 million for Future Cryogenics Plant Cooling Towers and Related Equipment Replacements;
- \$50.0 million for Future Secondary Clarifier Rehabilitations;
- \$7.5 million for Future Secondary Clarifier Drive Chain Replacement;
- \$1.0 million for Future Chemical Pipe Replacement;
- \$30.0 million for Future Sodium Hypochlorite Tank Rehabilitation;
- \$2.0 million for Future Sodium Bisulfite Tank Rehabilitation;
- \$3.0 million for Future Outfall Inspections;
- \$9.0 million for Future Centrifuge Back-drive Replacement;
- \$16.0 million for Future Centrifuge Replacements;
- \$30.0 million for Future Digester and Sludge Storage Tank Rehabilitation;
- \$3.0 million for Future Dystor Tank Membrane Replacements;
- \$8.0 million for Digester Sludge Pump Replacements;
- \$9.0 million for Future Transformer Replacements;
- \$6.0 million for Future LOCAT Scrubber Replacement;
- \$6.0 million for Future Combustion Turbine Generator (CTG) Rebuilds;
- \$4.0 million for Future Heat Loop Pipe Replacement;
- \$4.0 million for Future Hydroturbine Generator Rehabilitation;
- \$21.0 million for Future Electrical Equipment Upgrades;
- \$30.0 million for Future Switchgear Replacements;
- \$6.0 million for Future Odor Control Air Handler Replacements;
- \$4.0 million for Future DITP Process Instrumentation Control System (PICS) Distributed Processing Units (DPU) Replacements;
- \$4.0 million for Future DITP Process Instrumentation Control System Replacement;
- \$40.0 million for Future HVAC Upgrades/Replacement;
- \$5.0 million for Future Fuel Transfer Pipe Replacement;
- \$1.0 million for Leak Protection System Upgrade;
- \$2.0 million for Water Storage Tank Cleaning/Rehabilitation and Water Pipeline Rehabilitation;
- \$750,000 for Cathodic Protection Testing;
- \$2.0 million for Future Sanitary and Stormwater System Rehabilitation
- \$3.0 million for Future Personnel Protection Systems Upgrade/Replacement;
- \$6.0 million for Future Seawall Refurbishment;
- \$4.0 million for Future Barge Berth and/or Pier Facilities Rehabilitation;
- \$4.0 million for Personnel Dock Rehabilitation; and,
- \$12.0 million for Future Roof Replacements.

6.02 Facilities Overview

Wastewater from MWRA's 43 member sewer communities enters the DITP via three cross-harbor tunnels: two that serve north system communities and one that serves south system communities (Figure 6-1). The DITP process layout is shown in Figure 6-2. The limited available acreage on which to build the DITP facilities created space constraints that resulted in uncommon engineering solutions such as stacked clarifiers, centrifugal grit removal, on-site oxygen generation, and the distinctive egg-shaped digesters.



DITP is designed to process a maximum of 1.27 billion gallons per day of wastewater. The majority of north system flow is tributary to DITP's North Main Pump Station (NMPS) through two deep-rock tunnels, the North Metropolitan Relief Tunnel and the Boston Main Drainage Tunnel. The remainder of north system flow is transported by gravity to the Winthrop Terminal Facility (WTF) through the North Metropolitan Trunk Sewer. Flow from the NMPS and WTF then travels through two force mains to the DITP grit removal facility and is then conveyed to the primary clarifiers. Wastewater from the south system is tributary to the South System (Lydia Goodhue) Pump Station via the Inter-Island Tunnel. South system flow is introduced directly into the DITP primary clarifiers.

In the primary treatment process, wastewater moves slowly through large clarifier tanks where non-suspended solids settle to the bottom. Constantly moving chain and flight mechanisms slowly skim the floatables off the surface into scum collection tubes, and flights moving along the bottom scrape settled solids (primary sludge) into collection hoppers. The collected primary sludge and scum are pumped to gravity thickener tanks for further settling and water removal further concentrating the solids. Supernatant from the gravity thickeners is recycled through the plant and the thickened primary sludge and scum are pumped to anaerobic digesters. The primary clarifier effluent flows by gravity into "reactor/selector" tanks, to begin the biological secondary treatment process. A portion of settled sludge from the secondary clarifiers (containing microorganisms) is returned to these tanks, to keep an optimal concentration of microorganisms present in the reactors as the primary wastewater flows into the first reactor. Oxygen is also injected into the wastewater to promote further growth of these naturally occurring microorganisms, which feed on the organic matter in the wastewater. At this stage, the wastewater is called "mixed liquor" or "activated sludge". After passing through the reactor/selector tanks, the activated sludge enters the secondary clarifiers, which are operated in the same manner as the primary clarifiers. The secondary sludge settles out, leaving a clearer effluent that overflows the tanks into the secondary effluent channels. This secondary effluent is disinfected and discharged down a shaft into the outfall tunnel where it is dechlorinated and transported 9.4 miles out into the waters of Massachusetts Bay. The DITP effluent is discharged through diffusers along the last 1.5 miles of the outfall where it mixes with ocean currents.



Secondary sludge is collected from the bottom of the secondary clarifiers and pumped to the centrifuge facility where excess water is removed. Thickened secondary sludge is pumped to the anaerobic digesters, and centrate from the centrifuges returns to DITP for treatment. Thickened primary sludge, thickened secondary sludge, and concentrated scum all are mixed in the egg-shaped anaerobic digesters. Each of the 12 digesters holds three million gallons. The anaerobic digestion process involves maintaining a warm, well-circulated, oxygen-free environment to encourage the growth of anaerobic microorganisms. Over time, these microorganisms break down the sludge mixture into simpler compounds (methane gas, carbon dioxide, solid organic byproducts, and water). The methane gas produced in the digesters is used in DITP's Thermal Power Plant, while the digested sludge is pumped to MWRA's Residuals Pellet Plant in Quincy, where it is processed into fertilizer pellets. Pellet Plant operation and residuals disposal are detailed in Chapter 7.

6.03 Management and Staffing

The Director, Wastewater Treatment is responsible for the overall strategy and management of Deer Island, the Residuals Pellet Plant (see Chapter 7) and the Clinton Advanced Wastewater Treatment Plant (see Chapter 14). The Director, Wastewater Treatment reports to one of the Deputy Chief Operating Officers within MWRA's Operations Division. There are four Deputy Directors for each of the four Deer Island Departments: (1) Operations, (2) Maintenance, (3) Operations and Maintenance Support, and (4) Engineering Services. The four Departments (detailed below) comprise approximately 254 approved positions as of July 2012. The process used for development of the annual current expense and capital improvement budgets are also detailed in this Section.

Operations Department

The Operations Department consists of two functional groups: Wastewater Operations and Process Control. Operators and Area supervisors in the Wastewater Operations group are responsible for the operation and regulatory compliance of the wastewater treatment facilities and are assigned to the four main treatment process functional areas: power and pumping, primary treatment, secondary treatment/disinfection, and residuals. The Process Control group has Process Monitoring and Process Optimization units. Process Monitoring staff manages the monitoring and adjustment of process control set points, and development and management of day-to-day technical support for the Operations Department and management of the plant's Process Instrumentation and Control System (PICS), as well as the implementation of any process improvement or optimization initiative. Optimization initiatives managed by the group include efforts aimed at improvement in plant process control, as well as energy or chemical use reduction. Work performed by the Operations Department is supplemented by a series of service contracts, as listed below:

- PICS and instrumentation maintenance;
- All major chemical deliveries;
- Activated carbon replacements and nitrogen purging;
- Digester storage tank repairs; and
- Electric power purchase and supply.

Maintenance Department

The MWRA is committed to providing timely and efficient maintenance for the DITP to protect the facility and equipment assets. The Maintenance Department is responsible for performing preventive, predictive, and corrective maintenance on approximately 70,000 pieces of equipment. This Department consists of 135 staff, including laborers, painters, carpenters, electricians, plumbers, machinists, planner/schedulers, and facility management staff.

The Asset Management Group is in this Department. Asset Management Group responsibilities include optimizing crew size and productivity, developing cross-functional job descriptions, establishing a framework for the long-term maintenance program, construction coordination, and warranty work. A common issue in public utilities is that some amount of staff downtime can result from one tradesperson waiting for another tradesperson to perform a work task. Single-skill labor systems, which emphasize skill separation or specialization, are less flexible and require larger workforces to deliver services. DITP's workforce flexibility program is intended to minimize staff downtime. Workforce flexibility is the practice of improving quality and productivity through the use of cross-functional training and multiple-skill development for DITP staff. The objective of workforce flexibility is to promote skill sharing for tasks critical to maximizing the effectiveness of human resources. To this end, Deer Island has developed a program to significantly increase the flexibility of its workforce. An agreement with the affected trade unions was reached and staff have been trained to efficiently implement this program.

Work performed by the Maintenance Department is supplemented by a series of service contracts, as listed below:

- Maintenance for boilers, CTGs, STGs, wind turbines and hydroturbines;
- Crane and elevator maintenance;
- Centrifuge and oxygen generation facilities maintenance;
- Electrical equipment testing and maintenance;
- Instrumentation maintenance;
- Fuel supply (propane, gasoline and bio-diesel for vehicles);
- Overhead door maintenance;
- Odor control chemical treatment;
- Digester mixer repair and/or refurbishment
- Janitorial, pest control, grounds keeping, trash removal services;
- Laser alignment, vibration monitoring, and lube oil analysis services;
- Air balancing and lab hood certification support services; and,
- Catch basin inspection and cleaning services.

Operations and Maintenance Support Department

The Operations and Maintenance Support Department provides information, personnel and programs necessary to support the other DITP Departments. This Department consists of four functional groups: Administration and Finance, Safety/Security, Permits, and Thermal Power Plant. The Administration and Finance group is responsible for development of the DITP current expense budget (CEB), requisitioning of low cost items, and coordination with MWRA's Procurement Department to acquire major services and equipment. The Safety/Security group is responsible for

integration of environmental, safety and security initiatives into all plant activities. It also provides direction and leadership to the DITP Emergency Response Team, which is trained to respond to chemical spills and personal injuries. Safety staff issue all DITP photo identification cards and parking passes, oversee the security systems contracts, and participate in annual “right to know” and other training programs for DI staff and outside contractors. The Permits group is responsible for all plant permits except the NPDES permit. The Thermal Power Plant group is responsible for the operation and regulatory compliance of the on-site Thermal Power Plant, which is critical to providing supplemental and back-up electrical power needed to maintain uninterrupted treatment plant operations at DITP.

Work performed by the Operations and Maintenance Support Department is supplemented by a series of service contracts, as listed below:

- Site Security and facility hardening;
- Hazardous waste removal and emergency chemical response;
- Ambulance services (managed by the Town of Winthrop beginning in July 2012);
- Fire extinguishers and alarm systems maintenance;
- Closed circuit TV systems maintenance;
- As-needed locksmith services;
- Thermal Power Plant chemicals;
- Thermal Power Plant continuous emissions system audits and maintenance;
- Air quality compliance (assistance to Real Property staff); and
- Copier and fax machine maintenance.

Engineering Services Department

The Engineering Services Department develops technical specifications for service and construction contracts in all disciplines, and provides engineering services for in-house maintenance projects. Plant Engineering staff manage the three “As-Needed Technical Services” contracts, which provides engineering assistance by task order for some of the more complex projects undertaken by the Maintenance Department at Deer Island and at the Clinton Advanced Wastewater Treatment Plant.

Staff in Engineering Services work with all other Deer Island Departments to identify the capital improvement projects necessary to maintain and/or improve facility and equipment assets in order to achieve MWRA and regulatory objectives. The capital improvement program (CIP) budget process involves semi-annual coordination with Project Managers to compile the data and backup documentation for DITP projects. The Department executes and manages contracts necessary for completion of CIP projects, as well as manages the Technical Information Center, where record drawings, contract specifications, and equipment manuals are kept for reference as needed. Engineering Services staff work with other DITP groups and MWRA’s Procurement Department to develop, review and edit specifications for obtaining goods and services needed by all areas of DITP from outside suppliers. The contracts cover engineering services, construction projects, supply and delivery of chemicals, maintenance of specialized equipment and systems, and housekeeping (janitorial, pest control, trash removal, grounds keeping, etc.).

Work performed by the Engineering Services Department is supplemented by a series of service contracts, as listed below:

- NEFCo Contract for operation of the Residuals Pellet Plant (see Chapter 7);
- Three As-needed design consultant contracts (CIP task-order contract);
- Technical standards reference sources; and,
- Printing services.

DITP Budget Development Process

Annual DITP budgets are developed using a bottom-up approach. All cost center managers review the current expense budget (CEB) to determine appropriate annual needs. Managers coordinate with Department heads and review recent data from all the existing contracts as well as future usage projections to help develop the cost basis for many of the chemical and equipment maintenance items. Recent history is often used to project expected costs for most other items. The Deer Island Director and Deputies review the budget, and make decisions regarding the overall DITP CEB request.

The Engineering Services group compiles the annual capital improvement program (CIP) budget for DITP. Current cost and schedule data on existing projects is reviewed and, as with the CEB, a bottom-up approach for identifying new capital projects is used. Members of all maintenance and operations departments meet with Work Coordination managers to discuss any DITP issues that need to be addressed within the CIP. New projects, as well as projects previously proposed are reviewed and prioritized by the DI Director and Deputies. Projects believed to be of the highest priority are recommended for consideration in the CIP.

6.04 Operation and Maintenance of Deer Island

Given the significant value and critical nature of MWRA assets, maintenance is of paramount importance. In 1996, the MWRA Facilities Asset Management Program (FAMP) initiative was created as a comprehensive, agency-wide effort to efficiently and effectively manage water and sewer infrastructure. The goals of FAMP include coordinated, consistent asset inventory; condition assessment; maintenance scheduling; long-term replacement planning; and cost-effective operations and maintenance procedures. During start-up of DI facilities, MWRA conducted maintenance on a calendar schedule in accordance with the original equipment manufacturers' recommendations. This approach to maintenance was primarily driven by contractual obligations for equipment warranties. The Authority's management team believed that it was important to modify its existing program with the goal of achieving a more holistic approach to maintenance management. A key component of the FAMP initiative was implementation of Reliability Centered Maintenance (RCM) for all of the critical systems at Deer Island.

The computerized maintenance management software (CMMS) used by MWRA is MAXIMO. This software is used to manage all aspects of the DITP maintenance program including work-order management, planning and scheduling, asset management, resource management, tracking various maintenance costs, and generating reports for analyses. The software has tremendous data storage capabilities and is equipped with built-in failure analysis programs. In addition, MAXIMO contains the historical record for all maintenance activities, allowing staff to better address a problem with a

particular facility or piece of equipment. Staff can generate reports that compare current-year spending against historical spending for each asset, process area, and/or facility. This may indicate that an asset is nearing the end of its useful life (i.e., maintenance spending has increased significantly) and can provide advance warning to initiate the replacement planning process. Maintenance staff can prioritize tasks, assign work based on the availability of necessary parts and labor, and analyze equipment failures in order to implement appropriate preventive maintenance measures. MAXIMO's functionality includes a history of yearly costs for all 70,000 pieces of equipment at DITP. Current Condition Assessments are used to assist maintenance staff in determining when a particular asset needs to be scheduled for repair, upgrade, or replacement. DITP relies on an extensive predictive maintenance program, which has almost doubled the equipment tested over the last five years. Several non-invasive condition monitoring methods are used, including: vibration testing/data collection, acoustic ultrasonics, ultrasonic thickness measurement, lube oil sampling and analysis, and infrared thermography. These techniques are used to monitor and/or evaluate each asset's current and/or future condition. The time frame for a potential failure is indicated and allows the maintenance planning group to respond quickly before the asset is non-operational. The goal of predictive maintenance is to determine early detection and eliminate the possibility of catastrophic failure which could have major operational impacts or environmental and safety consequences for the Plant.

Service and Consultant Contracts Programmed in the FY14 CIP and Recommended for Consideration in Future CIPs:

- DI As-Needed Technical Design 7-1, 7-2, and 7-3 projects, used to supplement in-house engineering staff, are programmed in the FY14 CIP at a cost of \$3.923 million during FY14-16. The As-Needed Design contracts are task-order contracts with engineering firms that have multiple engineering disciplines (structural, civil, mechanical, electrical, chemical) as well as other technical consultants with expertise in fields such as hydrology, biology, landscape design, architectural design, marine biology, etc. Three contracts were issued and run concurrently for three years each. These resources are used to supplement the skills of in-house staff and provide assistance with developing specifications for various construction contracts needed to move DITP projects forward.
- DI As-Needed Technical Design Project that acts as a placeholder for CIP funds to be used as the As-Needed Contracts are developed. A budget of \$2.0 million annually for FY16-26 accounts for the total project budget of \$21.05 million.
- DI Future As-Needed Technical Design (placeholder) Project is recommended for consideration in future CIPs for continuation of the project at a budget of \$2.0 million annually for FY26-53 and a total cost of \$56.0 million.
- Various CEB-funded service contracts are issued to supplement work performed by DITP staff. Service contracts managed by individual DITP Departments are listed in Section 6.03.

Equipment Replacement Placeholder Programmed in the FY14 CIP and Recommended for Consideration in Future CIPs:

- DI Equipment Replacement Project provides a long-term placeholder budget for funding new projects and/or increases to existing projects for DITP equipment replacement. New projects or new subphases are deducted from the \$25.0 million placeholder budget programmed in the FY14 CIP during FY19-23.

- DI Future Equipment Replacement Project to provide a long-term placeholder budget for funding new projects and/or increases to existing projects for DITP equipment replacement is recommended for consideration in future CIPs at an estimated cost of \$2.0 million annually during the FY24-53 timeframe (total cost of \$60.0 million over 30 years).

6.05 Pumping and Preliminary Treatment

There are three pump stations on Deer Island: the South System (Lydia Goodhue) Pump Station, the North Main Pump Station, and the Winthrop Terminal Facility. North system flows (from the North Main Pump Station and the Winthrop Terminal Facility) pass through DITP grit removal (circular vortex grit chambers) prior to entering the primary treatment process. Each facility is detailed in this Section. Figure 6-3 shows the pumping process flow schematic.

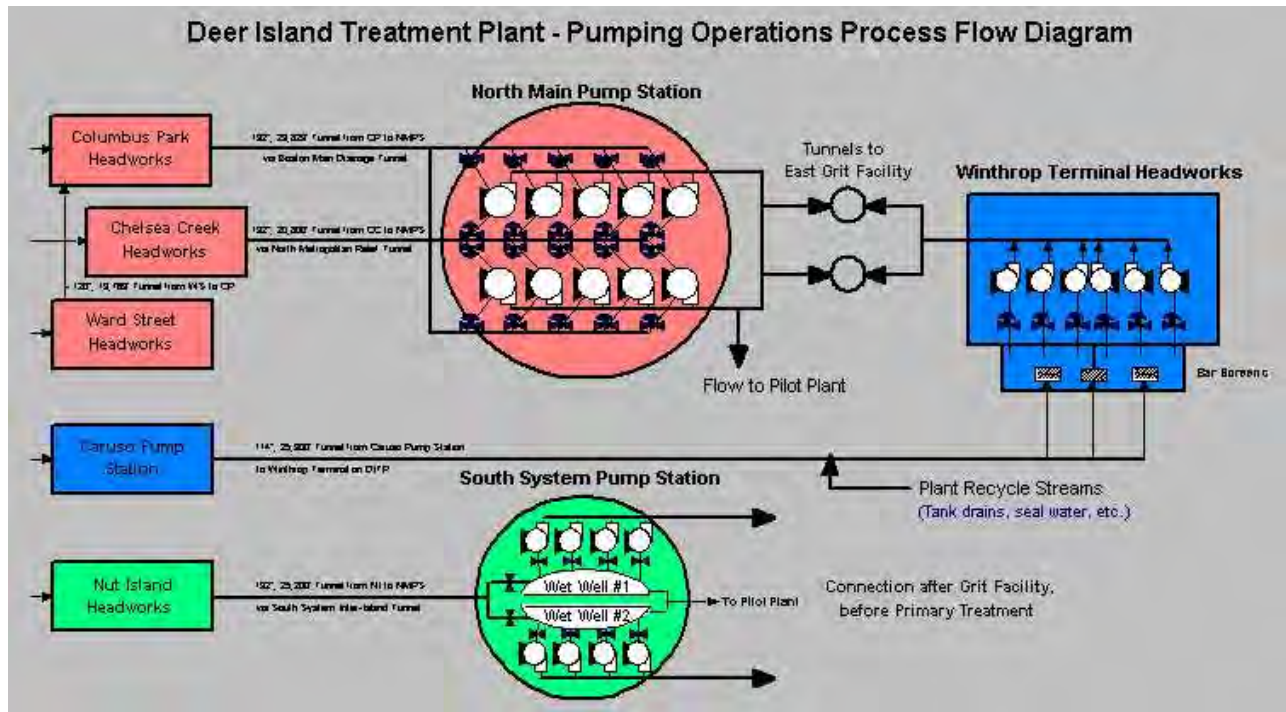

FIGURE 6-3 Pumping Process Flow Schematic

South System Pump Station

Facility Function and Operation: The South System (Lydia Goodhue) Pump Station (SSPS) is located just west of the DITP Grit Facility. Flow is conveyed 4.8 miles across Boston Harbor through the 11.5-foot diameter Inter-Island Tunnel from the Nut Island Headworks. On Deer Island, an 11-foot influent conduit conveys flow to the influent chamber from the north shaft of the Inter-Island Tunnel. Flow is directed from the influent chamber through sluice gates to one or both of



the semi-circular wet wells. Each set of four pumps discharges to one of two force mains that deliver south system flows to the North System Grit Facility effluent channel, to be combined with the north system and recycle flows. The total flow is then split between Primary Clarifier Batteries. An alternative discharge location for the south system flows directly to Primary Clarifier Battery D is available, allowing for isolation of the south system flow, however, it is rarely used. In this mode, the two 96-inch force mains discharge into the Battery D primary influent channel ahead of the venturi flow control valve. Two pair of 96-inch motor-operated butterfly valves located in the Pretreatment Gallery can divert the flow. Functional testing was completed in January 1996 and substantial completion was in February 1996. Preventive maintenance continued at SSPS until the Inter-Island Tunnel and Nut Island Headworks were completed. On March 13, 1998, steel plates were removed from the Nut Island effluent channel, allowing flow to the South System Pump Station. On July 8, 1998, all flow from the South System was diverted to the Inter-Island Tunnel for treatment at DITP.

Facility Components: The SSPS has eight raw wastewater pumps, six operating at peak flow and two standby. The two wet wells are each served by four Worthington vertical, non-clog centrifugal pumps rated for 66.7 mgd and equipped with mechanical seals. The 60-inch pump suction piping is equipped with a motorized gate valve to provide a tight shutoff when maintenance is required. The 54-inch pump discharge is equipped with a check valve, a 48-inch flow meter, and butterfly valve.

Hydraulic Performance: The SSPS wet wells were designed to receive from 80 mgd to 400 mgd. Design flows for the SSPS are based on the design pump capacity of 66.7 mgd per pump. Peak flow is based on hydraulic capacity of the High Level Sewer, the Nut Island Headworks, and the Inter-Island Tunnel. Minimum flows of 80 mgd are handled using one or two pumps. Average flows of about 150 mgd are handled using two or three pumps. Peak flows up to 400 mgd are handled using up to six pumps. Since startup of the SSPS, modifications were made to the plant's hydraulic profile under typical operating conditions. The design called for the pump rate to be set by several factors, including the water surface elevation at the Nut Island Shaft and the head loss due to friction in the Inter-Island Tunnel. The set points were modified to keep the Nut Island shaft water elevation as high as possible. The SSPS level is controlled by pumping the amount equal to

the inflow, with adjustments made to maintain level in the tunnel shaft. This reduces the head working against the SSPS pumps.

Facility Power: The eight pumps are driven by synchronous electric motors through VFDs. The motors on the ground floor level are connected to the pumps through three sections of shafting. The motors are rated for 343 to 1,250 horsepower with a minimum pump speed of 260 rpm and a maximum of 400 rpm. Two 13.8 kV-to-480V transformers provide station service through a nearby substation and the Thermal Power Plant provides back-up power.

Recent Upgrades Completed:

- In FY07-08, the VFDs were replaced in the SSPS and pump packing seals were replaced with mechanical seals.

Projects in the FY14 CIP and Future Recommended Upgrades:

- Future SSPS Variable Frequency Drives (VFDs) Replacement design/construction is programmed in the FY14 CIP at \$24.0 million in FY18-21 and is also recommended for consideration in future CIPs (every 10-15 years) at an estimated cost of \$24.0 million each cycle with a target schedule of FY26, FY36 and FY46 and a total cost during the Master Plan period of \$72.0 million.
- SSPS Pump Lube System Replacement to change the pump lubrication system from the current system using grease to a new system using oil is programmed in the FY14 CIP at \$2.9 million in FY19-21. Once installed, the new system will require only routine maintenance, not replacement.
- Future SSPS Shaft and/or Motor Replacements to replace worn shafts and/or obsolete motors in the South System Pump Station is recommended for consideration in future CIPs (every 20-25 years) at an estimated cost of at \$6.0 million each cycle with a target schedule of FY18 and FY40 and a total cost during the Master Plan period of \$12.0 million. Replacement of all eight pump motors is planned for every other cycle that the VFDs are replaced.

North Main Pump Station

Facility Function and Operation: The North Main Pump Station (NMPS) was initially constructed in 1968 as part of the original DITP. It is located on the northwest corner of Deer Island, near the Thermal Power Plant and was rebuilt in 1991 under the Boston Harbor Project. The NMPS receives flow from the North Metropolitan Relief Tunnel (from the Chelsea Creek Headworks) and the Boston Main Drainage Tunnel (from Columbus Park and Ward Street Headworks). Butterfly and knife gate valves can be configured so that any of the pumps can pump from either of the influent tunnels to either of the two force mains on Deer Island (North System Tunnels 1 and 2), conveying the flow to the DITP Grit Facility.



Facility Components: The NMPS houses ten pumps and motors. The pump station is approximately 120 feet in diameter and has seven levels, from the lowest level where the suction piping is located, up to the ground floor where the pump motors and discharge piping are located. Each motor has a variable frequency drive, and each pump discharges through a flow meter. Knife gates and 60-inch butterfly valves on both sides of each pump allow for maintenance isolation. The discharge side of each pump also has a check valve.

Hydraulic Performance: Four pumps can handle the peak design flow of 350 mgd from the North Metropolitan Relief Tunnel, and four pumps are needed for the peak design flow of 438 mgd from the Boston Main Drainage Tunnel, allowing for two standby pumps. The pumps are valved to pump to North System Tunnel No. 1 or 2. A cross-connection allows the pumps to discharge to either tunnel. Each vertical non-clog centrifugal pump is rated for 110 mgd maximum. Nine of the pumps discharge through a magnetic flow meter; the venturi meter for pump 10 was not replaced. An algorithm in the distributed control system manages the speed of the pumps and adjusts the speed to match headworks flow and maintain a set point shaft level at the remote headworks.

Facility Power: Each pump is driven by a 3,500-hp electric motor with a VFD. Four 13.8-to-4.16 kV transformers in a nearby substation provide power to the NMPS motors as well as to the WTF switchgear and equipment. A second substation with two 4.16kV-to-480V transformers provide station service to the NMPS. Back-up power is provided to all DITP facilities through the Thermal Power Plant's electric power generation equipment.

Recent Upgrades Completed:

- In FY07-08, the NMPS pump packing seals were replaced with mechanical seals and the butterfly valves were evaluated for replacement.
- The first phase of NMPS Motor Control Center (MCC) replacement was complete in FY13.

Projects in the FY14 CIP and Future Recommended Upgrades:

- NMPS VFD Replacements including design, ESDC, REI, and construction is programmed in the FY14 CIP at \$18.212 million in FY14-16 (project also includes motor replacements).
- Future NMPS VFD Replacement design/construction (every 10-15 years) is programmed in the FY14 CIP at \$22.1 million in FY22-25 and is also recommended for consideration in future CIPs (every 10-15 years) at an estimated cost of \$22 million each cycle with a target schedule of FY38 and FY48 and a total cost during the Master Plan period of \$44.0 million.
- NMPS Harmonic Filter Replacement is programmed in the FY14 CIP at \$3.0 million in FY19-21. This project is planned to be combined with the VFD replacements.
- Future NMPS Motor Replacements (to be coordinated with VFD replacements) is recommended for consideration in future CIPs (every 20-25 years) at an estimated cost of at \$12 million each cycle with a target schedule of FY38. Replacement of all ten pump motors is planned for every other cycle that the VFDs are replaced.
- NMPS sequential replacement of the Motor Control Center (MCC) that is currently obsolete and unreliable is programmed in the FY14 CIP at a total cost of cost of \$6.086 million in FY15-17. Future MCC replacements (every 18-20 years) are also recommended for consideration in future CIPs at \$10 million for each subsequent cycle with a target schedule of FY34 and FY52.

- NMPS Replacement of the remaining nine of ten 60-inch Butterfly Valves for isolating pumps (this project is combined with WTF Plug Valve Replacement) is programmed in the FY14 CIP at a cost of \$10.0 million in FY14-16.
- NMPS removal of the diesel engines (Enterprise Engines) is recommended for consideration in future CIPs at an estimated cost of \$600,000 with a target schedule of FY19. The schedule for this project may be accelerated.

Winthrop Terminal Facility

Facility Function and Operation: The Winthrop Terminal Facility (WTF), also part of the original 1968 Deer Island Wastewater Treatment Plant, was reconstructed in 1991 under the Boston Harbor Project. The WTF is located on the northwest corner of Deer Island, near the North Main Pump Station, and provides both screening and pumping of influent wastewater. The WTF receives flow from the North Metropolitan Trunk Sewer, which serves East Boston, Revere, Chelsea and Winthrop. It also receives flow from DITP's recycle and sanitary flow streams. Influent wastewater is screened by mechanically cleaned bar screens, discharged to one of two wet wells, and then pumped through the North System Tunnels to the DITP Grit Facility.



Facility Components: The motor and pump area of WTF consists of three levels. The sub-basement contains three influent channels, two wet wells, and the pump room which houses six pumps. The basement level contains the screen room and operating floor. The uppermost level houses the screenings discharge area with vacuum/wash press equipment, motor room, and personnel facilities. There is an electrical substation at ground level, adjacent to the motor room.

Hydraulic Performance: The six original lift pumps were replaced in order to pump from the WTF to the force mains leading to the DITP Grit Facility. Some pumps regularly pump to North System Tunnel 1; others pump to North System Tunnel 2. A cross-connection is provided to allow the pumps to discharge to either tunnel. The six pumps are rated for 10 to 32 mgd, (throttled down to deliver low flows). Four pumps are needed to deliver the peak flow of 125 mgd, with two on standby. The number of pumps needed is determined from the water level in the two wet wells. Each pump has its own suction line with an isolation valve downstream of the sluice gates, screens, and wet wells. Each 36-inch discharge line has a check valve, an isolation plug valve, and a magnetic flow meter.

Facility Power: Each pump is equipped with a VFD in conjunction with a 600-hp motor. Station power comes through a nearby substation and the Thermal Power Plant provides back-up power.

Recent Upgrades Completed:

- In FY07-08, the WTF pump packing seals were replaced with mechanical seals and the plug valves were evaluated for replacement.

Projects in the FY14 CIP and Future Recommended Upgrades:

- WTF Replacement of six 36-inch Plug Valves for isolating pumps (this project is combined with NMPS butterfly valve replacement) is programmed in the FY14 CIP at a cost of \$10.05 million in FY14-16.
- WTF design/construction to Replace Variable Frequency Drives (VFDs) that are currently obsolete at the WTF and miscellaneous smaller VFDs throughout the DITP is programmed in the FY14 CIP at \$4.796 million in FY14-17 and design/construction for future WTF VFD replacement is also recommended for consideration in future CIPs (every 10-15 years) at an estimated cost of \$3 million each cycle with a target schedule of FY25, FY35, and FY45.
- Future design/construction to replace additional miscellaneous Variable Frequency Drives (VFDs) is programmed in the FY14 CIP at \$6.667 million in FY15-21 and also recommended for consideration in future CIPs (every 10-15 years) at an estimated cost of \$7 million each cycle with a target schedule of FY28, FY38, and FY48. Each replacement cycle takes at least five years to complete if replacements are performed by in-house staff, since they are completed in batches and there are several hundred of these VFDs.
- Future WTF Shaft and/or Motor Replacements to replace worn shafts and/or obsolete motors in the Winthrop Terminal Facility is recommended for consideration in future CIPs (every 20-25 years) at an estimated cost of at \$3 million each cycle with a target schedule of FY25 and FY45. Motors will be replaced every other cycle that VFDs are replaced.

Deer Island Grit Facility

Facility Function and Operation: The DITP Grit Facility is designed to remove grit from screened wastewater pumped from the North Main Pump Station and the Winthrop Terminal Facilities. The grit removal facility is designed to protect downstream equipment that could be damaged by grit, such as sludge collector mechanisms, pumps, and centrifuges. North System flows from the NMPS and WTF are transported to the DITP Grit Facility through two 11.5-foot force mains (North System Tunnels east and west). Each tunnel splits into two 7-foot riser pipes, which enter the center influent channel at the Grit Facility, and feeds the circular vortex grit chambers. Substantial completion of the Grit Facility occurred on December 15, 1994, with facility start-up on January 20, 1995. All remote headworks have horizontal-flow grit removal equipment (see Chapter 8). However, flow conveyed to DI through the North Metropolitan Trunk Sewer is only screened at the Winthrop Terminal Facility. Grit removal is accomplished at the DI Grit Facility. The grit process flow diagram is shown in Figure 6-4.



FIGURE 6-4 Grit and Primary Treatment Process Flow Diagram

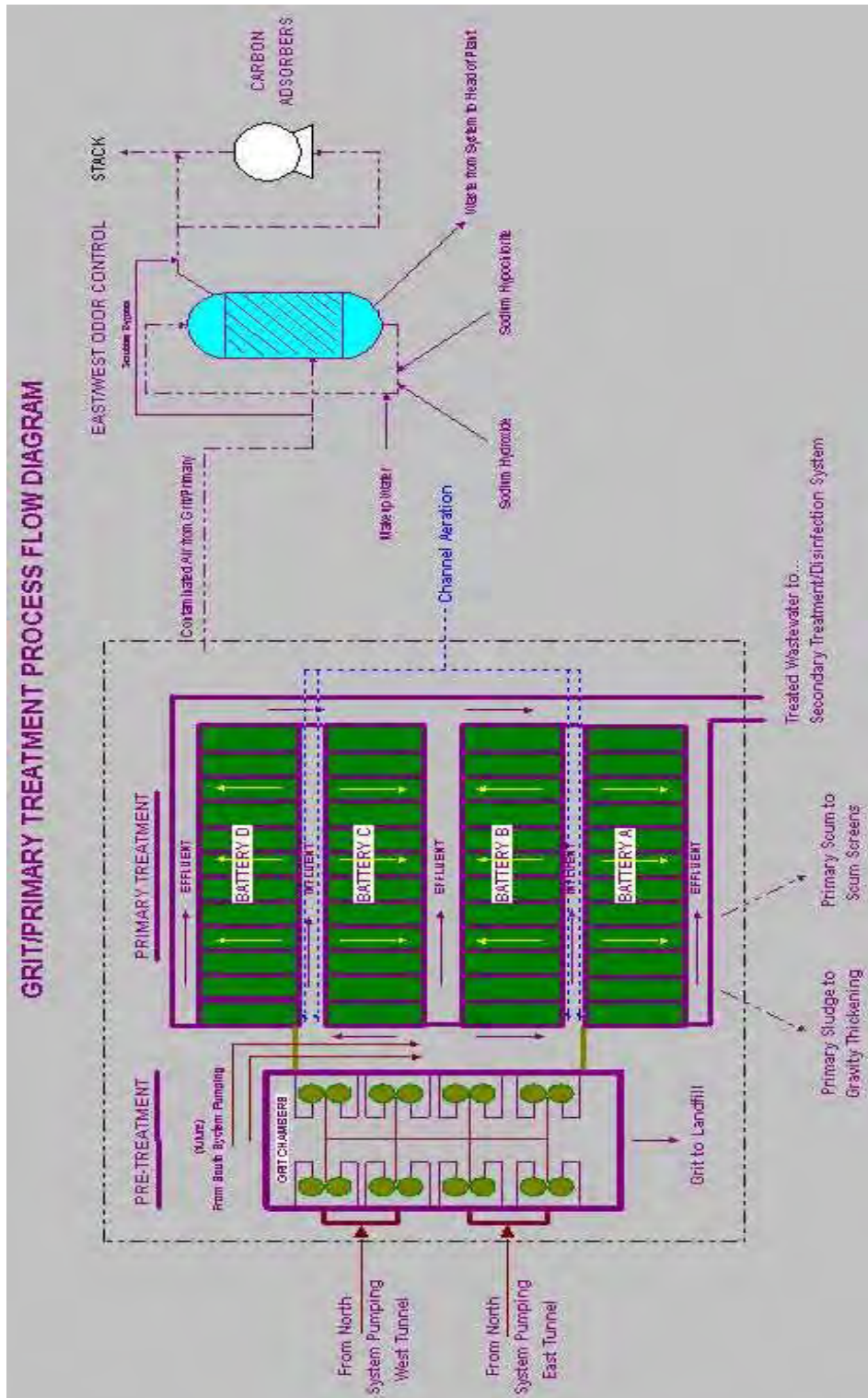

Facility Components: The structure encloses 16 circular vortex grit chambers, screw classifiers, belt conveyors, air handling units, air compressors, wastewater channels, and two truck loading bays for grit removal and disposal.

Hydraulic Performance: Flow from North System Tunnels 1 and 2 riser pipes enters the grit facility's center influent channel, then enters each of the grit chambers tangentially through an approach channel and undergoes either a clockwise or counterclockwise rotation of 270° before exiting over a weir and into the sloped, common effluent channel. All effluent exits the grit facility on the north side of the building and flows into an effluent distribution chamber. Typically 14 of the 16 circular vortex grit chambers are in service and two on stand-by. Each unit has a hydraulic loading rate of 23.6 mgd (design average) and 65 mgd (design peak). The grit removal efficiency is dependent on the grit mesh size. Heavy organics and grit are moved to the outer wall of the vortex grit chamber by centrifugal force, then settle to the bottom of the grit chamber where a paddle mixer "washes" the organics from the heavier grit particles. The particles that pass through the mixer settle into the grit hopper at the bottom of the chamber. An airlift system cycles to raise the mixture of grit and water through a pipe at the center of the chamber and discharge it to a screw classifier.

The screw classifier provides further removal of organics and water from the grit, and discharges the washed grit onto belt conveyors. Each belt conveyor serves four grit chambers and transfers the grit to two shuttle conveyors. The shuttle conveyors, each serving eight grit chambers, distribute grit into trailers located in the truck-loading bays. The shuttle conveyor belt direction is reversible so that a second trailer may be filled while the first trailer is still in place. The design loading rate per belt conveyor is 8 tons per hour and shuttle conveyor design loading rate is 16 tons per hour.

Facility Power: The Grit Facility is powered by two 13.8kV-to-480V transformers that provide station service through substation switchgear. The Thermal Power Plant provides back-up power.

Recent Upgrades Completed:

- In FY10, the prior high-maintenance grit blower system was replaced with a dedicated air-handling/compressor system for improved grit handling.

6.06 Primary Wastewater Treatment

Facility Function and Operation: Primary wastewater treatment involves distributing the influent into the stacked primary clarifiers, where the flow is slowed so that non-suspended solids settle to the bottom. Chain driven mechanisms supported along the sides of each tank have lateral flights which alternately skim the floatables across the surface of the tank to scum collection troughs, then travel to the bottom of the tanks and move settled sludge to cross-collection channels and into sludge hoppers. The upper and lower tanks are hydraulically connected to allow sludge from the upper tank to settle to the hoppers located in the lower tank. Cross collectors move the settled sludge across the hoppers, to where it is intermittently pumped out by the primary sludge pumps. The primary treatment process flow diagram is shown in Figure 6-4. A cross-sectional depiction of one stacked clarifier is shown in Figure 6-5.



FIGURE 6-5 Primary Clarifier

Facility Components: The primary treatment facilities have a total of 48, stacked rectangular clarifiers divided into four batteries (batteries A, B, C, and D), each containing 12 primary clarifiers. The primary treatment facilities were constructed under two construction packages, with Batteries A and B, the Central Blower Facility, and associated galleries and support systems coming online in January 1995. Primary Clarifier Batteries C and D came online in September 1995. The Central Blower Facility provides low-pressure air for the aerated channels throughout the plant.

The primary sludge pumping system transports sludge from the clarifiers to the gravity thickener distribution box at the residuals handling facilities. A total of 18 centrifugal pumps are provided for 12 stacked clarifiers in each battery. Pumps are variable speed, with design capacity of 550 gpm.

The primary scum system is designed to collect floatables in the primary clarifiers. The major components are the collector mechanisms; tip tubes, scum wells, pumps, rotating drum screens, scum concentrators, and primary and concentrated scum piping. Each upper and lower tank is equipped with two 16-inch diameter tip tube skimmers for a total of four tip tubes per clarifier; one for each chain and flight mechanism. The primary scum pumping system transfers scum removed from the primary clarifiers to the gravity thickener complex where it is screened and concentrated prior to digestion. Each of the 14 primary scum pumps is rated for 480 gpm to 775 gpm. Discharge piping from the scum wells in each battery connects into a single 10-inch scum header in the pretreatment gallery, which runs through the gallery to the scum screening facility in the gravity thickener complex. Scum is thickened prior to digestion, to reduce the amount of water going to the digesters. Ten progressive cavity pumps transfer concentrated primary scum from the scum wells to the digesters.

Hydraulic Performance: The hydraulic capacity of the four primary treatment batteries was designed to match the maximum transmission capacity of the north and south collection systems and associated pump stations at 1.27 billion gallons per day. The clarifiers were designed to handle this flow rate through the four batteries with 42 of 48 clarifiers in service. Under normal operation, the North System and South System flows are combined, and treated in two of the four primary batteries. During peak flow periods, or when less than 10 clarifiers are available per battery, additional clarifiers are placed into service. The South System piping is also configured to allow for isolated treatment of South System flows in Primary Battery D.

Flow entering the aerated primary battery influent channels is distributed to each of the stacked clarifiers through submerged inlet ports. Flow moves slowly to the opposite end of the clarifiers and over weirs located behind the scum baffles. Each clarifier discharges into a trough leading to the battery effluent channel, which then empties into a common primary effluent cross-channel spanning the width of the four primary batteries. Primary effluent can then be distributed to the secondary treatment facilities, or bypass secondary through drop shafts and channels leading directly to the disinfection facility.

A flow totalizer sums four primary battery flow meters, providing a raw wastewater total flow measurement for the plant. The design flow range is 75 mgd to 360 mgd for each battery. This flow measurement is also used to pace the feed rate of disinfection chemicals and also flow-paces primary influent composite samplers.

Facility Power: The primary clarifier batteries and related equipment are powered through two substations, each with two 13.8kV-to-480V transformers. The Thermal Power Plant provides back-up power.

Recent Upgrades Completed:

- In FY12, the first phase of the Primary Clarifier Rehabilitation Construction project to replace longitudinal chains and sprockets and some shafts, along with minor concrete repair was completed. In addition, the primary tip tubes which were failing were removed. The units will be replaced in a future contract.

Projects in the FY14 CIP and Future Recommended Upgrades:

- Expansion Joint Repairs construction 2 and 3 for clarifiers and retaining walls will continue the ongoing program to periodically replace failed expansion joints in the concrete clarifier decks and/or various retaining walls. This project is programmed in the FY14 CIP at a cost of \$2.699 million during the FY14-18 timeframe.
- Clarifier Rehabilitation to replace deteriorated water flushing lines (W3H Flush System) is programmed in the FY14 CIP at a cost of \$71,000 million during FY14. This project was awarded at in July 2012 and will be completed in FY14.
- Clarifier Rehabilitation (primary and secondary) to replace scum skimmer tip tubes is programmed in the FY14 CIP at a cost of \$20.0 million during FY14-17.
- Clarifier Rehabilitation Phase 2 for primary and secondary clarifiers design and construction is programmed in the FY14 CIP at a cost of \$30.0 million during FY14-21. This project is a follow-up to the recently completed phase 1 primary and secondary clarifier rehabilitation project. Additional work needed to correct noted deficiencies includes: influent gate seals, effluent launders, primary sludge removal system, secondary aeration/recirculation system, and concrete corrosion.

6.07 Secondary Wastewater Treatment

The secondary wastewater treatment process at Deer Island is a biological process, utilizing microorganisms to break down the compounds present in primary effluent, thereby improving wastewater quality prior to discharge. The microorganisms are mixed with the primary effluent in “selector/reactors”. They are selectors because the mode of operation (aerobic or anaerobic; high vs. low recycle rates; high vs. low microorganism concentrations, etc.) determines the predominant types of microorganisms that will thrive in the environment. They are also reactors because the microorganisms are actively processing (eating and breaking down the various compounds that are present) wastewater in the tanks. The mix of microorganisms and wastewater is also referred to as “mixed liquor” or “activated sludge”. Figure 6.6 shows the secondary treatment processes, including the selector/reactors; the polymer feed locations, the waste & return sludge lines, and the secondary effluent channels.

At DITP, the secondary reactor tanks are operated for aerobic microorganisms that require oxygen to survive. Air does not have enough oxygen to maintain the target of greater than 2 mg/l of dissolved oxygen, given the volume of wastewater passing through the secondary reactors. To achieve optimal transfer of oxygen into the wastewater, pure oxygen is maintained in the headspace above the activated sludge in the reactors. This oxygen is generated on-site in the Cryogenics Facility. Large motorized paddles keep the secondary reactor tanks mixed and facilitate the transfer of oxygen into the activated sludge.

After passing through the selector/reactors, the activated sludge enters the secondary clarifiers, which function similarly to the primary clarifiers. The main purpose of the secondary clarifiers is to allow the microorganisms to sink to the bottom of the tanks to be collected and removed. This “secondary sludge” is withdrawn from the clarifiers, with a portion of the flow being reintroduced to the selector/reactors (“return sludge”) to maintain the desired microorganism concentrations. The remaining secondary sludge (“waste sludge”) is thickened and sent to the digesters.

Secondary Selector/Reactors

Facility Function and Operation: Primary effluent flows into the secondary selector/reactors, where it mixes with activated sludge to begin the secondary treatment process. Each of the secondary reactors (designated A, B, and C) has three process trains, to biologically treat the primary effluent wastewater flow. The process trains are compartmentalized into a total of seven stages. Each compartment has openings in the walls to allow passage of activated sludge (mixed liquor), scum/foam, process gas, and purge air to the next stage. Each stage is designed to function as a complete mixed compartment within the process train. The first three stages can function as “selectors” that can be operated for aerobic or anaerobic treatment of the wastewater. Surface aerators and lower mixing impellers are designed to maintain a homogenous mixture within each stage.

Facility Components: The first and second selector stages are about 43 feet long by 35 feet wide, and each has a two-speed mixer; the third stage is 43-feet long by 70-feet wide and has two dual-speed mixers. Each mixer operates at high speed in the aerobic mode (to aid in oxygen transfer) and low speed in the anaerobic mode (to just keep the activated sludge from settling). The last four stages of each process train are oxygen reactor stages, 70 feet long by 70 feet wide. The gas is vented from the last stage of each process train, through an oxygen vent control valve. Purge air blowers maintain a safe environment by removing detected combustible gases to eliminate a potentially explosive situation.

Hydraulic Performance: All stages have an average liquid depth of 25 feet. High purity oxygen is provided to meet the oxygen demands of the activated sludge process while maintaining a dissolved oxygen concentration greater than 2 mg/l in all reactor stages. The high-purity oxygen gas enters the first selector stage above the liquid surface when the selectors are being operated aerobically. Valves in the oxygen feed line control the oxygen flow to each process train. Oxygen supplied to each process train is transferred to the activated sludge through mechanical surface aeration. Bottom-mixing impellers on each stage's aerator-mixer shaft assembly maintain mixing and suspension of the activated sludge in the tank.

Facility Power: The secondary selector/reactor batteries are powered through six 13.8kV-to-480V transformers providing station service through three substations. The Thermal Power Plant provides back-up power.

Ongoing Upgrades:

- As part of routine maintenance, when necessary, major pieces of equipment such as aerator mixer motors may be sent off-site for refurbishment.

Cryogenic Facility

Facility Function and Operation: The Cryogenic Facility separates oxygen from the other components in air, creating concentrated and purified oxygen (in both liquid and gas forms) for use in the secondary selector/reactors. Gaseous oxygen is transferred to the oxygen dissolution system in the reactor basins. The liquid oxygen is transferred to storage. The nitrogen gas waste stream is utilized for cooling the inlet compressed air and then vented to the atmosphere. Facility start-up occurred in January 1997, six months in advance of the start-up time for Secondary Battery A.

Facility Components: The Cryogenic Facility contains two sets of equipment that filter, compress, cool, and separate air to produce pure oxygen. The air separation units (cold boxes) separate air into gaseous oxygen, gaseous nitrogen, and smaller amounts of liquid oxygen. The waste stream from the units is 90-98 percent nitrogen with fractions of oxygen, argon, and other elements. The liquid oxygen system consists of a 1,000-ton storage tank and two 300-ton per day liquid oxygen vaporizers (one operating and one standby). The cryogenic system capacity is 80-300 tons per day.



Facility Power: Two 13.8kV-to-416V transformers provide service power through a nearby substation. The Thermal Power Plant provides back-up power.

Projects in the FY14 CIP and Future Recommended Upgrades:

- Ancillary Modifications Final design and construction 4 for modifications to the cryogenic facility, plant-wide odor control systems, digester gas, and scrubber improvements are programmed in the FY14 CIP at a cost of \$15.124 million during FY15-21.
- Cryogenics Plant Chillers Replacement project to replace three failing air chillers that require frequent maintenance in the oxygen generation plant is programmed in the FY14 CIP at a cost of \$1.1 million during FY14-15.
- Cryogenics Plant Equipment Replacement design and construction to replace pumps, valves, motors, sensors, switches, instrumentation, etc. at the Cryogenics Plant is programmed in the FY14 CIP at a cost of \$6.9 million in FY14-17.
- Future Cryogenics Plant Equipment Replacement design and construction is recommended for consideration in future CIPs (every 10-15 years) at an estimated cost of \$2.0 million each cycle and a target schedule of FY25, FY35, and FY45.
- Future Cryogenics Plant Cooling Tower and Related Equipment Replacement is recommended for consideration in future CIPs (every 20 years) at an estimated cost of \$1.5 million each cycle and a target schedule of FY20 and FY40.

Secondary Clarifiers

Facility Function and Operation: There are three secondary clarifier batteries designated A, B, and C, located adjacent to the corresponding reactor/selectors. Each secondary clarifier battery has 18 stacked clarifier sets and receives flow from the corresponding oxygen reactor battery through an aerated influent channel. Flow enters the upper and lower levels of each clarifier via submerged ports. The ports (four upper and four lower) are located at the same elevation in the influent channel.



Pipes extend the inlet flow beyond the sludge hopper horizontally into the upper clarifiers and through drop pipes into the lower clarifier. An inlet baffle dissipates energy, providing quiescent flow conditions that promote settling of the solids, and evenly distributes flow entering the tanks. Effluent is collected at the opposite end of the tanks in an effluent trough, which discharges to a 14-foot wide battery effluent channel. Chain and flight sludge collector mechanisms move settled sludge along the bottom of the tanks and scum across the surface, in the same fashion as discussed in the primary clarification sections. A portion of the activated sludge pumped from the collection hoppers is returned to the selector/reactors, and the rest is sent to the centrifuge facility. Secondary effluent flows from each effluent channel into the disinfection facility. Secondary Battery A started operating in June 1997, Battery B by December 1997, and Battery C by December 2000.

Facility Components: Each clarifier has a longitudinal sludge and scum collector, which operate the same as in the primary clarifiers. The flights scrape sludge along the bottom of each tank toward the influent end, rise to the surface, and return to the effluent end of the clarifier, pushing scum along the surface in the upper section and along the underside of the concrete slab in the bottom clarifier. The three secondary clarifier batteries are equipped with 27 return activated sludge pumps. Three pumps are provided for every two clarifiers with two pumps operating and one on standby. Return sludge is measured with a magnetic flow meter on each pump discharge and controlled through the PICS system. Waste sludge is withdrawn from each battery return sludge header with a rate-of-flow controller. Discharge of waste sludge is directed to the residuals facilities or the primary battery influent channel. Each process train is equipped with a scum removal system to remove scum that could otherwise build-up and adversely impact process performance.

A secondary polymer system is provided to dispense polymer into the influent channels of the secondary clarifier batteries to enhance settling and maintain effluent quality during periods of peak flow. There are two polymer systems, one for mixing batches from dry polymer, and one for mixing batches from liquid emulsion polymers. Each system has storage and mixing tanks, dilution tanks, mixers, pumps, piping, and valves required for facility operation. The systems are sized for dosing secondary influent with polymer at 1 to 2 mg/l.

Hydraulic Performance: The secondary clarifiers were designed to process 100 percent of primary effluent under normal dry weather conditions and higher flows up to 700 mgd. Processing flows at too high a flow rate [such as during peak (wet weather) flow conditions above 700 mgd] could disrupt the settling capacity of the clarifier, and decrease the effluent quality. Any primary effluent in excess of the secondary treatment capacity can be routed directly to the disinfection basin, where it is mixed with secondary effluent and chlorinated prior to discharge.

Facility Power: The secondary clarifier batteries and related equipment are powered through two substations, each with two 13.8kV-to-480V transformers. The Thermal Power Plant provides back-up power.

Recent Upgrades Completed:

- In FY12, the first phase of the Secondary Clarifier Rehabilitation Construction project to replace longitudinal chains and sprockets and some shafts, along with minor concrete repair was completed.

Projects in the FY14 CIP and Future Recommended Upgrades:

- Clarifier Rehabilitation (primary and secondary) to replace scum skimmer tip tubes is programmed in the FY14 CIP at a cost of \$20.0 million during FY14-17.
- Clarifier Rehabilitation Phase 2 (primary and secondary clarifiers) design and construction is programmed in the FY14 CIP at a cost of \$30 million during FY14-21. This project is a follow-up to the recently completed phase 1 primary and secondary clarifier rehabilitation project. Additional work needed to correct ongoing deficiencies includes: influent gate seals, effluent launders, primary sludge removal system, secondary aeration/recirculation system, and concrete corrosion.

- Future Secondary Clarifier Rehabilitations are recommended for consideration in future CIPs (every 15-20 years) at an estimated cost of \$25.0 million each cycle with a target schedule of FY30 and FY45.
- Future Secondary Clarifier Drive Chain replacements are recommended for consideration in future CIPs (every 10-15 years) at an estimated cost of \$2.5 million each cycle with a target schedule of FY26, FY36, and FY46.

6.08 Disinfection and Dechlorination

The Disinfection Facilities include four sodium hypochlorite storage tanks, two sodium bisulfite storage tanks, two disinfection basins, the disinfection gallery, and associated processes and support systems. Start-up of the permanent disinfection facility occurred on December 14, 1995. Figure 6-7 shows the flow diagram for the disinfection process.

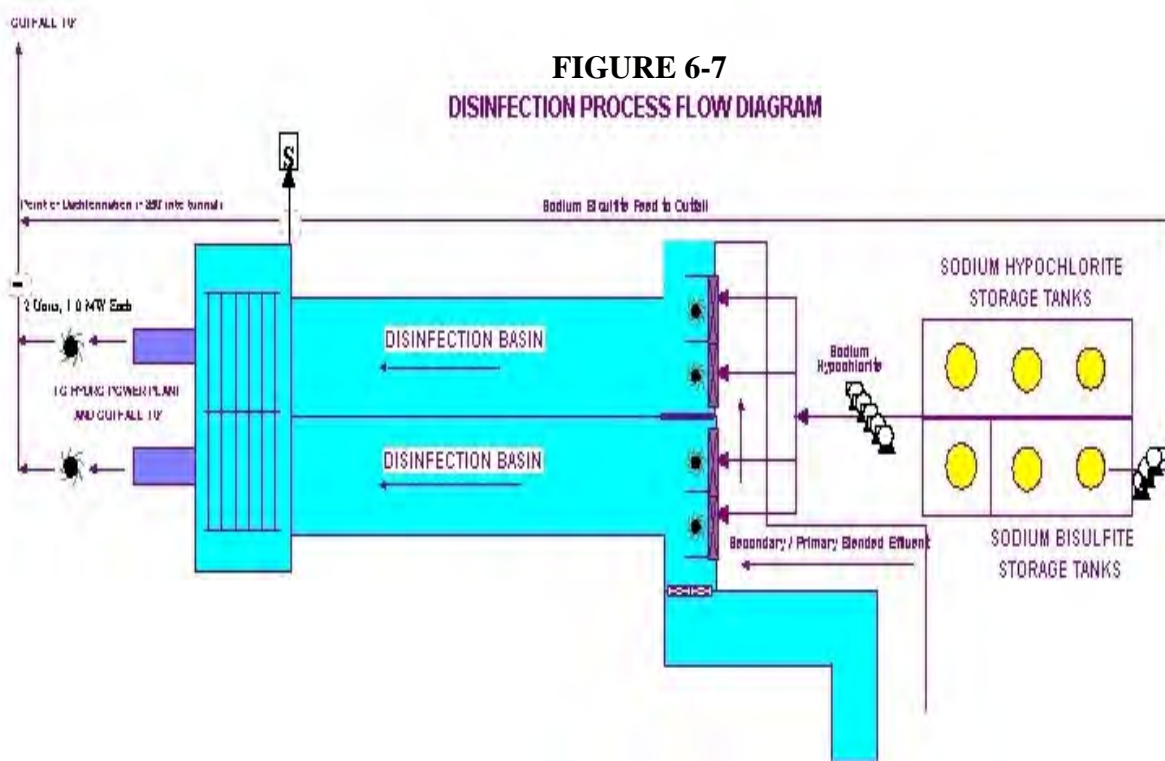

Facility Function and Operation: All plant flow is directed into the disinfection basins for post-treatment chlorination. The outfall bypass conduit remains, to allow use of the existing emergency outfalls in the event the deep-ocean outfall must come off-line. The Disinfection Facilities includes storage and handling facilities to receive sodium hypochlorite deliveries from both truck and barge, and transfer sodium hypochlorite to various locations throughout the plant. Two 12-inch diameter sodium bisulfite solution pipes are attached to the inside wall of the drop shaft and tunnel to deliver dechlorination chemicals to the treated effluent approximately 800 feet downstream of the drop shaft. This takes advantage of a portion of the tunnel volume for chlorine contact time to meet regulatory standards under peak storm conditions.

Sodium Hypochlorite Storage: Four 250,000-gallon tanks are provided for storage of up to 20 percent sodium hypochlorite in an outdoor tank farm surrounded by a containment wall. Each tank is 40 feet in diameter, 30 feet high, covered and vented to the atmosphere through a fume abatement unit. They are top-loaded to prevent the contents from draining if the feed line breaks. As of July 2012 sodium hypochlorite delivery by truck



is the least-cost option. Barge delivery was previously used; however, delivery by barge has become prohibitively expensive. Each sodium hypochlorite tank has a storage capacity of several weeks based on the annual average usage. To help avoid rapid sodium hypochlorite decomposition due to high temperatures, the tanks are insulated. The tanks have an ultrasonic monitoring system that displays tank level and high/low level alarms in PICS. The sodium hypochlorite pumped to the disinfection basins is flow-paced to match the metered flows through DITP.

Facility Power: The disinfection basins and related equipment are powered through one substation, with two 13.8kV-to-480V transformers. The Thermal Power Plant provides back-up power.

Recent Upgrades Completed:

- In FY07-08, the sodium hypochlorite tank liners were removed and replaced in all four storage tanks, including removing ladders and replacing safety railings on the storage tanks.
- Disinfection hose pumps are routinely replaced under the CEB.

Projects in the FY14 CIP and Future Recommended Upgrades:

- Sodium Hypochlorite Pipe Replacement Design, Construction and REI to replace about 0.5 mile of PVC piping that transports sodium hypochlorite throughout various areas of the plant is programmed in the FY14 CIP at a cost of \$10.558 million during FY14-17. This 4-year project will address issues of pipeline corrosion and leakage problems that currently require frequent attention from maintenance staff.
- Chemical Pipeline Replacement design and construction for planned periodic replacement of various chemical pipelines in the disinfection and odor control facilities due to deterioration from corrosion is programmed in the FY14 CIP at a cost of \$2.757 million during FY16-19. Future Chemical Pipeline Replacement/Upgrade design and construction is also recommended for consideration in future CIPs (every 20 years) at a cost of \$500,000 for each cycle with a target schedule of FY33 and FY53.
- Sodium Hypochlorite Tank Rehabilitation to strip and reline the four sodium hypochlorite tanks is programmed in the FY14 CIP at a cost of \$10.0 million in FY18-22 and future phases of Sodium Hypochlorite Tank Rehabilitation are recommended for consideration in future CIPs (every 10 years) at an estimated cost of \$10.0 million for each project phase (\$2.5 million per tank) with a target schedule of FY30, FY40, and FY50.
- Sodium Bisulfite Tank Rehabilitation to strip and reline the two bisulfite storage tanks is programmed in the FY14 CIP at a cost of \$2.543 million in FY15-17 and recommended for consideration in future CIPs (every 15 years) at an estimated cost of \$1.0 million per project phase (\$500,000 per tank) with a target schedule of FY30 and FY45.

6.09 Outfall Tunnel and Effluent Discharge

Facility Function and Operation: Disinfected treatment plant effluent can either pass through or bypass the hydropower facility, to the outfall shaft. The outfall chute connects with the tunnel shaft at an invert elevation of 87 feet, which then drops vertically 357 feet to the outfall tunnel invert at elevation -270 feet. The shaft has a finished inside diameter of 30 feet. From the bottom of the shaft, the outfall tunnel was drilled northeasterly from Deer Island 9.4 miles out into Massachusetts Bay. The outfall tunnel has a finished inside diameter of 24.25 feet for 8.15 miles to the diffuser segment. The precast tunnel liner has six trapezoidal segments in each ring, with neoprene gaskets between all joints. Along the 1.25-mile diffuser segment, the tunnel diameter tapers to maintain an approximately equal head on the diffuser system. The diffuser system consists of 55, 2.5 foot diameter riser pipes, each topped with a mushroom-shaped eight-nozzle diffuser cap that mixes the effluent in the 100-foot deep waters of Massachusetts Bay. The discharge undergoes an initial dilution of at least 70 to 1, which increases depending on the effluent flow rate, the ambient current speed, and ambient stratification. The outfall tunnel and diffuser system were placed into continuous service on September 6, 2000. Figures 6-8 and 6-9 depict the outfall tunnel and a cross-section of a riser and diffuser.

Hydraulic Performance: The anticipated hydraulic performance of the outfall was set forth in the DP-6 Hydraulic Design Report (1995). This report considered the situation where all eight diffuser ports in each of the 55 risers would be open. Instead, it was decided to initially open fewer than the total 440 ports. This reduced number of open ports would convey close to the design peak flow of 1,270 MGD at high tide. The 440 ports were needed to convey the peak design flow with an aged (and hence hydraulically rougher) outfall, for a sea level of 116 ft, corresponding to 100-year storm surge with a 1.9 foot allocation for sea-level rise (M&E, 1989). Another purpose of the reduced number of ports opened initially was to allow verification of the predicted outfall hydraulics, and refine the number of required open ports.

Future Recommended Upgrades:

- DI Future Outfall Inspection Project is recommended for consideration in future CIPs (every 20 years) to inspect and make recommendations for cleaning, upgrades, and/or rehabilitation for the DI outfall tunnel, as well as the DI emergency outfalls at an estimated cost of \$3.0 million per phase beginning in FY20 and FY40 with a 1-year project duration.

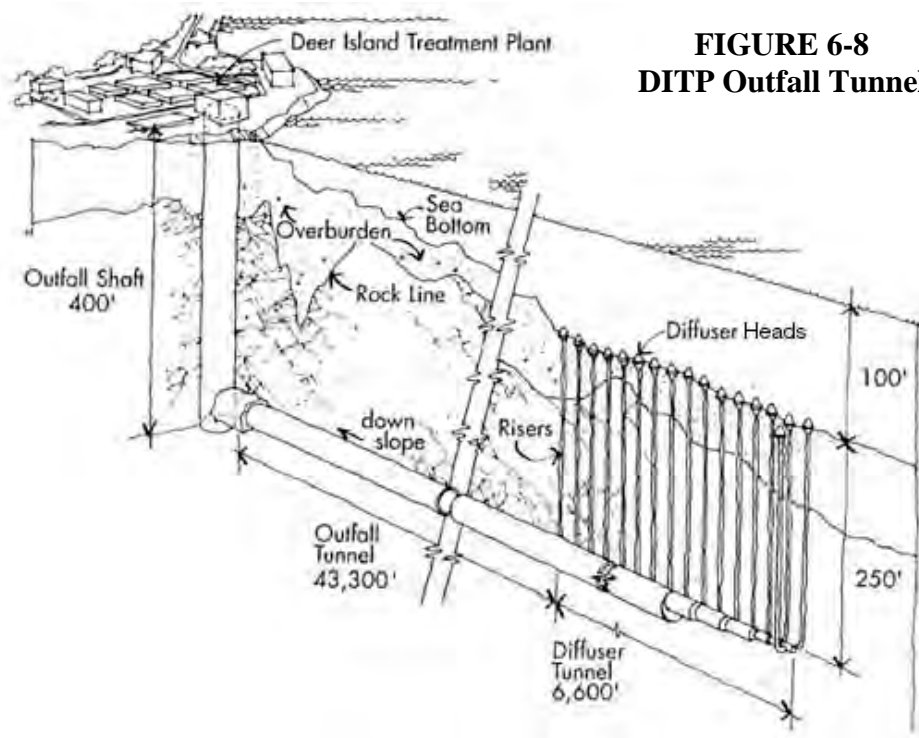
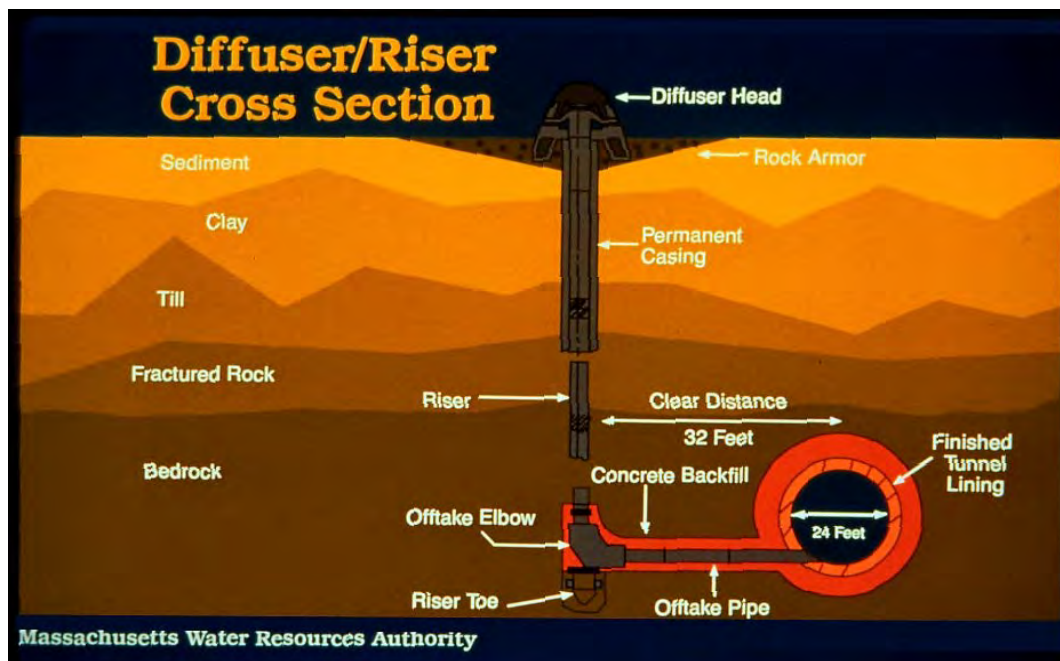

FIGURE 6-8
DITP Outfall Tunnel

FIGURE 6-9
DITP Outfall Tunnel Cross Section



6.10 Residuals Processing

Residuals processing at DITP includes five major functions: (1) gravity thickening of primary sludge and scum; (2) centrifuge thickening of secondary sludge; (3) digestion of thickened sludge; (4) sludge and digester gas collection and storage; and (5) sludge pumping to the Residuals Pellet Plant. These functions are detailed in this Section.

Gravity Thickening of Primary Sludge

Facility Function and Operation: Six gravity thickeners are used to concentrate sludge and scum removed from the primary clarifier batteries. The primary sludge pumping system transports sludge from the clarifiers to the gravity thickener distribution box. The gravity thickeners allow the sludge to settle and scum to be skimmed from the top of the tank, increasing the solids concentration prior to digestion.



Facility Components: Full-surface skimming equipment is installed in each gravity thickener tank to collect scum and floatables. Each tank has a 12-foot diameter rake arm that revolves around the tank, directing scum toward a scum tip tube. A total of 10 triplex plunger pumps are located in the lower level of the gravity thicker complex. The pump discharge is directed through one of two redundant headers that are connected with the thickened waste sludge headers to form thickened combined sludge leading to the sludge digesters. The gravity thickener overflow exits each tank over a V-notch weir and is pumped as plant recycle flow to the primary treatment facility. Each gravity thickener/scum concentrator is covered and ventilated to an odor control facility.

Hydraulic Performance: All six tanks are able to receive a mixture of primary scum and primary sludge or primary sludge alone. Tanks 1 and 2 are configured to function as either scum concentrators or gravity thickeners. These two tanks, which are capable of receiving screened scum discharged directly from the rotating scum screens, have raised covers with enclosed walkways. The design average flow per concentrator is 2.31 mgd.

Facility Power: The gravity thickener facility and related equipment are powered through one substation, with two 13.8kV-to-480V transformers. The Thermal Power Plant provides back-up power.

Projects in the FY14 CIP and Future Recommended Upgrades:

- The CEB contains funds for routine overhauls of gravity thickener equipment at about \$50,000 per year. Several of the pie-shaped sections of the fiberglass covers over the gravity thickeners have been replaced using CEB funds, as needed, at approximately \$12,000 each. Recoating of the thickener overflow boxes was included in one of the painting and coating contracts.

- Gravity Thickener Rehabilitation Improvements design and construction is programmed in the FY14 CIP at a cost of \$5.786 million during FY14-16. This 3-year project will be multi-phased including the following components: replacing fiberglass covers, installation of catwalks around tanks, effluent channel improvements, and upgrades to the roof of the sludge thickener building for access and operating efficiency improvements.
- Gravity Thickener Center Column Replacement project is programmed in the FY14 CIP at a cost of \$498,000 during FY14. Complete replacement of the center columns in all four gravity thickener tanks with a higher grade steel is required based on previous experience with failures in FY11. This project began in FY13.

Centrifuge Thickening of Secondary Sludge

Facility Function and Operation: Centrifuges are used to thicken waste sludge from secondary treatment because secondary sludge does not settle well in gravity thickeners. Centrifuges increase the solids concentration from about 0.5 percent to 5 percent before the waste sludge is pumped into the digesters. To aid in the sludge thickening process, the waste sludge is dosed with polymer prior to passing through the centrifuges.



Facility Components: The Centrifuge Building has 12 waste sludge and 4 digested sludge centrifuges. Prior to the Braintree-Weymouth Interceptor coming on line, digested sludge was thickened using centrifuges before being barged from DITP to the Pellet Plant. Currently, the digested sludge is pumped directly to the Pellet Plant at 2 to 3 percent solids concentration. The digested sludge centrifuges are no longer used for this purpose and are available for use as waste sludge centrifuges, or for polymer testing (with some minor piping reconfigurations). The facility also houses dry and liquid polymer feed systems, sludge pumps, and appurtenances. Six centrifuge feed pumps are used for pumping waste secondary sludge to the centrifuge feed header. The thickened waste sludge is discharged into two wet wells and is then pumped to the digesters. The centrate is discharged to one of two centrate wells. The centrate is mixed and pumped to the liquid treatment facilities where it is recycled to either the primary clarifier influent shafts or the primary clarifier effluent channels. There are four polymer systems that use liquid polymer.

Facility Power: The centrifuge building is powered through three substations, each with two 13.8kV-to-480V transformers. The Thermal Power Plant provides back-up power.

Projects in the FY14 CIP and Future Recommended Upgrades:

- The CEB includes \$275,000 per year for centrifuge refurbishments required for work outside the scope of the annual centrifuge maintenance contract.

- Centrifuge Back-drive Replacement Project is required due to equipment obsolescence and is programmed in the FY14 CIP at a cost of \$3.868 million during FY14-15. This project began in FY13. A future centrifuge back-drive replacement project is recommended for future CIPs (every 10 years) at an estimated cost of \$3.0 million for each phase with a target schedule of FY25, FY35, and FY45.
- Centrifuge Replacement design and construction with target of replacement of 4 of 16 worn centrifuges at 10-year intervals is programmed in the FY14 CIP at a cost of \$20.8 million. This initial project covers the first two phases of centrifuge replacement (each a 5 to 6-year project) with phase 1 in the FY16-21 timeframe and phase 2 in the FY24-28 timeframe. Future Centrifuge Replacements are also recommended for consideration in future CIPs (4 of 16 centrifuges every 10 years) at an estimated cost of \$8.0 million for each project (\$2.0 million per centrifuge) with a target schedule of FY34 and FY44.

Digestion of Thickened Sludge

Facility Function and Operation: Anaerobic digestion is a biological sludge stabilization process where bacterial microorganisms convert organic material into two main by-products: methane and carbon dioxide. Sludge and concentrated scum is pumped by the thickened primary sludge pumps and the concentrated scum pumps through 10-inch lines into the digester complex. This flow is combined with thickened waste sludge from the centrifuges to form thickened combined sludge, which is the influent flow to the anaerobic digesters. Temperature is one of the critical factors affecting the environment within the digesters and ability to maintain an effective sludge stabilization process. Each of the three digester modules has a separate digester-heating loop to control the temperature of the four egg-shaped digesters. The equipment is located in the basement of each digester module building.



Facility Components: Each of the three digester modules containing four egg-shaped, 3.0 million gallon anaerobic digesters for the digestion of thickened primary and waste activated (secondary) sludge. Module 1, 2, and 3 were completed sequentially in July 1995, December 1995, and December 1997. Three of the four digesters in each module serve as active digesters, while one is typically used for storage of digested sludge. Two sludge and gas storage tanks are located just north of Digester Module 1. All of these facilities are prominently located on the southeast side of Deer Island. The four digesters in a module are oriented in a rectangular pattern with an equipment building in the center of each module. The basement level of the equipment building contains sludge piping, sludge heat exchangers, sludge recirculation pumps, and related process equipment. The upper level contains digester gas piping. A stair and elevator tower provides access to the top of the digesters. The tower is connected to the digesters by elevated walkways.

Hydraulic Performance: The digesters operate in an overflow mode. As raw sludge enters the recirculation loop, digested sludge overflows through telescoping sludge withdrawal pipes to the sludge discharge box located at the top of the digester. Displaced digested sludge exits through the tank's effluent line and flows by gravity to the digested sludge storage tanks.

The digester heating loop is designed to maintain sludge temperatures in each of the 3-million gallon anaerobic digesters within the mesophilic range of 85°F to 100°F. The design temperature set point is 98°F. The primary source of heat for the digester complex is the recirculation of hot water piped from the Thermal Power Plant. Five sludge heat exchangers per module transfer heat from the heat supply loop to the circulating sludge. For each module, six recirculation sludge pumps (two standby) are used for circulating the sludge from the sludge heat exchangers to the digesters. Each sludge heat exchanger also has a dedicated circulating water pump to circulate heated water through the sludge heat exchanger.

A central mechanical draft tube mixing system, sized for a minimum of seven turnovers per day, provides mixing in each of the digesters. The mechanical mixing system is normally operated in the upward flow mode, with periodic reversal of the impeller to help break up any foam or scum layer and to remove accumulated rags and debris from the impeller. If *Nocardia* bacteria are present, downward pumping will also help control foaming. In the event that this foam control mechanism is not sufficient, the digester gas conveyance system is equipped with foam separators to protect the gas compressors and other components of the gas system. In addition, the facility is equipped with a ferric chloride dosing system to control the formation of struvite.

A co-digestion pilot project is being implemented starting in FY14 following successful bench-scale testing. The project will evaluate the impacts of adding food waste, oils and grease to the digesters at DITP and determine what changes in sludge characteristics may result that could have an impact on the residual Pellet Plant process. The project is intended to develop additional digester gas production resulting in heat/power savings. The co-digestion pilot project was added to the CIP for FY14-16 at a budget of \$250,000 and is carried in Chapter 7. Based on the outcome of the pilot project, additional capital expenditures at DITP and/or at the Pellet Plant may be recommended but are not identified in the 2013 Wastewater System Master Plan.

Facility Power: Each digester module is powered through a substation, with two 13.8kV-to-480V transformers. The Thermal Power Plant provides back-up power.

Projects in the FY14 CIP and Future Recommended Upgrades:

- Digester Modules 1 & 2 Pipe Replacement design and construction to replace the most critically deteriorated glass lined piping is programmed in the FY14 CIP at a cost of \$542,000 during FY14. The project began in FY12 and will be completed in FY14. This 3-year project represents the first phase of sludge piping upgrades.
- Digester and Storage Tank Rehabilitation design, ESDC, and construction to upgrade the three digester modules and two gas handling/sludge storage tanks is programmed in the FY14 CIP at a cost of \$24.7 million during FY14-22. This 9-year project represents the second phase of improvements to the sludge digesters and gas handling/sludge storage tanks and will include: sludge piping upgrades, valve replacement, recirculation/mixing system improvements, overflow box upgrades, digester wall steel replacement or repair, digester coating, etc.
- Future Digester and Storage Tank Rehabilitation design and construction are recommended for consideration in future CIPs (every 15 years) at an estimated cost of \$15.0 million for each phase and a target schedule of FY30 and FY45.

Sludge and Digester Gas Collection and Storage

Facility Function and Operation: The digested sludge overflow from the digester modules flows by gravity into one of the two sludge and gas storage tanks. The gas collected from the top of each digester also flows to these tanks, where special membrane systems maintain an adequate pressure based on the flow of gas. Gas produced in the anaerobic digesters is used to supply as much of DITP's thermal energy requirements as possible. Since the digesters have no usable gas storage, low-pressure gas storage is provided in the two digested sludge and gas storage tanks by a membrane-type gasholder cover. Each tank has a reticulated dome support structure and two membranes. Digester gas is stored in the space between the inner gas membrane and the liquid in the tank. The usable gas volume is 120,000 cubic feet for each tank. Air is pumped into the space between the two membranes to maintain a constant pressure on the methane gas.



Facility Components: Two 3-million gallon sludge and gas storage tanks, piping, pumps and appurtenances. The gas and sludge storage tanks have two membranes on top, an inner gas membrane and an outer air membrane. Three centrifugal blowers in the gas handling facility supply air to the space between the two membranes. During normal operation, a blower runs continuously and the relief valve opens or closes to control the volume of air in the air chamber in order to maintain system operating pressure. The digester gas handling system collects the digester gas and transfers it to the Thermal Power Plant where the gas is fired in boilers to create steam which is used to heat water, supplying the plant heat loop. If gas production exceeds thermal demand, excess heat is dissipated in a dump condenser. A digester gas purification system is located in the Thermal Power Plant building. It consists of a LO-CAT hydrogen sulfide oxidation process to remove hydrogen sulfide from the digester gas. The LO-CAT system has two flow trains for treating the digester gas, each with an absorber, oxidizer/settler, sulfur-dewatering unit, and chemical feed system.

System Performance: Collection of digester gas to low-pressure storage begins in the gas dome located on each digester cover, from which gas escapes through a 10-inch pipe. Dual-pressure vacuum relief valves and flame arresters are located on the top of each digester. The gas production pipe runs externally along the digester cover, down the digester sidewall through the building roof, to a foam separator in the digester building. From the foam separators, the pipe connects to a gas collection header that receives gas from each digester, and then runs along the upper walkway into the gas and sludge storage tanks. Gas compressors are not required because the gas flows naturally from the digesters due to the internal gas pressure. The addition of digested sludge to the storage tank increases the gas pressure. As pressure increases, the air relief valve opens and the air chamber

deflates. If the air chamber is fully deflated and pressure still increases, the flares operate to eliminate surplus gas. If pressure still increases, the emergency relief valves on the gas storage domes will open and release gas. The removal of digested sludge from the storage tank also results in decreasing gas pressure in the system. As the pressure decreases, the air chamber inflates. If the gas pressure is dropping when the air chamber is fully inflated, differential pressure sensed across the gas piping and air piping will shut down the air blower. If gas pressure drops further, the gas compressors will be shut down. If the pressure is still dropping, the emergency relief valves on the gas storage dome will open to protect the tank from excess vacuum.

Facility Power: The sludge and gas storage tanks and equipment are powered through a substation with two 13.8kV-to-480V transformers. The Thermal Power Plant provides back-up power.

Recent Upgrades Completed:

- In FY05-06, the digester gas storage membranes were replaced after one of the outer membranes tore. Based upon experience, it is expected that the membranes will need replacing every 8 to 10 years.
- The original digester gas chiller installed with the gas handling facility was oversized and did not operate well at the low end of the operating range; it was replaced in FY04.

Projects in the FY14 CIP and Future Recommended Upgrades:

- Dystor Tank Membrane Replacements are programmed in the FY14 CIP at a total cost of \$3.0 million to be performed in two phases, each 1-year projects. The first phase has a budget of \$1.2 million in FY17 and the second phase has a budget of \$1.8 million in FY25.
- Future Dystor Tank Membrane Replacements are recommended for consideration in future CIPs (every 10 years) at an estimated cost of \$1.0 million for each phase and a target schedule of FY33, FY43, and FY53.
- Digester Gas Flare #4 design and construction is programmed in the FY14 CIP at a cost of \$1.515 million during FY19-21.

Sludge Pumping to the Residuals Pellet Plant

Facility Function and Operation: Digested sludge is pumped from the sludge and gas storage tanks through one of two 14-inch force mains that run approximately seven miles from DITP to the Residuals Pellet Plant in Quincy. The 14-inch pipelines pass through about 300 feet of piping galleries, then run underground about 250 feet alongside the Inter-Island Tunnel shaft. The force mains then penetrate the outer wall into the Inter-Island Tunnel and are embedded in concrete along one side of the 11-foot diameter tunnel. The force mains connect into a vault at Nut Island and continue through Braintree-Weymouth Tunnel to the Pellet Plant.

Facility Components: Digested sludge is pumped at 2 to 3 percent solids via three 250 horsepower hydraulic piston diaphragm pumps. Each pump is rated up to 800 gpm. The system is designed to have two pumps operating with the third pump on standby, which provides for a maximum flow of 1,600 gpm. Sludge quantities delivered to the pellet plant range between 6 and 9 million gallons per week, depending on sludge production rates at DITP. Under normal operation, the flow rate is maintained at between 1,200 and 1,350 gpm from Monday through Saturday morning. Sludge pumping is shut down Friday night through Monday morning, when the pellet plant is normally

unattended. The lines are normally flushed with plant process water (W3H) for 12-24 hours prior to being secured for the weekend to avoid the buildup of sludge material in the lines. With both digested sludge storage tanks in operation, sludge storage capacity without pumping to the Pellet Plant is 5 to 6 days. If one of the tanks is off-line for any reason (as occurred when each of the gas membranes were replaced) sludge storage capacity at Deer Island ranges from two to three days.

Hydraulic Performance: During the first year of operation following completion of the Braintree-Weymouth Tunnel, there were some problems with the pumping system, including mechanical failures of the pumps (mostly corrected under warranty by the vendor), and slamming, hammering, and pipe movement due to the reciprocating nature of the positive displacement piston diaphragm pumps. In addition to premature wear and damage to pump components, the hammering was severe enough to cause a pipe separation in one of the underground force mains. The failed force main was repaired by the contractor under warranty. Re-configuration of the pipe restraints for both force mains near the point of failure was also performed. With one force main in use and the second a redundant element of the system, sludge pumping can continue in the event of the loss of one force main. If two of the diaphragm pumps were to fail, a single diaphragm pump can barely keep up with the sludge production at Deer Island. It has been demonstrated that with sufficiently high head in the sludge storage tanks, some sludge can be pumped to the Pellet Plant by utilizing the centrifugal chopper pumps (furnished under Contract 5316 as tank recirculation pumps); however, these pumps cannot pump adequate quantities under all necessary head and pressure conditions. A new centrifugal pump has been installed on a pilot basis to replace the existing diaphragm pumps. If proven to be successful, a second centrifugal pump will be added and the original diaphragm pumps will be removed.

The original sludge barge loading station and connection hoses are still in place; however, these were mothballed when the force main sludge pumping system came on line. The barge system for sludge transport had a high cost and no barge is kept available. With the sludge barges decommissioned, loss of both sludge force mains would require either intensive emergency work to repair one of the force mains or rapid acquisition of a suitable sludge barge. Fortunately, the simultaneous loss of both force mains is unlikely, since only one force main is used at a time and the second is held as a back-up.

Recent Upgrades Completed:

- In FY12, one new centrifugal digested sludge pump and a flushing pump were added to the sludge pumping system. Replacement of the remaining three diaphragm pumps is scheduled to occur after the new centrifugal pump is tested for at least six months. These pumps transfer sludge from DITP to the Residuals Processing Pellet Plant in Quincy.

Projects in the FY14 CIP and Future Recommended Upgrades:

- Digester Sludge Pump Replacement construction (Phases 1 and 2) to transfer sludge to the Pellet Plant is an extended project that began in FY10 and will be completed in FY16. A remaining cost of \$5.474 million is programmed in the FY14 CIP during FY14-16.
- Future Digested Sludge Pump Replacements are recommended for consideration in future CIPs (every 20 years) at an estimated cost of \$4.0 million for each phase and a target schedule of FY30 and FY50.

6.11 Electrical Generation and Distribution

Five electric power sources are currently available for DITP: (1) the cross-harbor marine cable connected to NSTAR's K Street Substation in South Boston; (2) the Thermal Power Plant on Deer Island; (3) the Hydropower Facility at DITP outfall shaft; (4) three wind turbines; and (5) three roof-mounted and one ground-mounted solar photovoltaic arrays (on the residuals/odor control building, the maintenance/warehouse building, the grit building, and on the ground adjacent to parking lot #2). Power from the various sources is distributed on Deer Island via the electrical distribution system which includes an array of switchgear and substations. These facilities are detailed in this Section.

Cross-Harbor Marine Cable

Facility Function and Operation: The primary source of electric power for DITP is a 17-mile marine cable embedded beneath the floor of Boston Harbor. The cable is owned and operated by Harbor Electric Energy Company, an unregulated wholly-owned subsidiary of NSTAR. The cross-harbor cable was placed into service in 1991. Capital, operating and maintenance cost of the cable and substation are funded under a 25-year interconnection agreement that expires in 2015. The interconnection agreement may be extended under terms to be negotiated commencing at least two years prior to the expiration of the agreement. There has been no activity related to renegotiating the agreement, however, staff anticipate another lease period being agreed.

Facility Components: The cross-harbor marine cable supplies 115,000 volt, 3-phase power from NSTAR's K Street Substation in South Boston. The marine cable terminates on Deer Island at the NSTAR high voltage substation where it connects to two transformers that step down the system voltage from 115,000 volts to 13,800 volts. The transformers connect to the plant electrical distribution system via two bus duct systems supplying 13,800 volts to Bus "A" and Bus "B" of the Main Switchgear, which provide redundant power throughout the DITP facility.

Future Recommended Upgrades:

- DI Cross-Harbor Cable Dredging Construction is recommended for consideration in future CIPs as a contingency at \$20.0 million during the FY15-18 timeframe. As a result of a major navigation channel improvement project being planned by the U.S. Army Corps of Engineers (Army Corps) and Massport, a dispute has arisen in which the Army Corps asserts that the cable was not installed at the appropriate depth in certain locations, as specified in its Army Corp permit, and portions must be relocated to permit the navigation improvement project to proceed. The MWRA has formally disclaimed any liability and responsibility for relocating the cable, nonetheless, a \$20 million contingency fund is recommended for consideration for inclusion in future CIPs. It is expected that the Army Corps will proceed with its schedule to have the cable relocated by FY18. NSTAR and the Army Corps are currently in litigation over this issue.

Thermal Power Plant

Facility Function and Operation: The Thermal Power Plant (TPP) is located on the north end of DITP, adjacent to two fuel storage tanks. The TPP contains the boilers required to meet all of DITP's heat loads, as well as generators and ancillary equipment needed to generate supplemental and/or back-up electric power for all of the critical DITP facilities. Power is generated from two combustion turbine generators (CTGs) and one steam turbine generator (STG). The TPP is capable of delivering a total capacity of 71.1 MW of electric power



from two CTGs rated at 26 MW each, and one STG rated at 19.1 MW. From the TPP control room, operators monitor and manage the boiler operations as well as matching the generated electric power phasing and conditions to the rest of the Deer Island grid and the incoming power from the cross-harbor marine cable. The wind turbines and solar arrays at Deer Island feed directly into the power distribution system and do not require any phase matching or other efforts by TPP staff. Turnover of the various components of the TPP occurred in three stages between August 1995 and February 1999. The layout of equipment in the Thermal Power Plant is shown on Figure 6-10.

According to a DITP load study analysis conducted from January 1999 to April 2001, the average operating power demand recorded at the Main Switchgear Building was 19.4 MW with a peak operating power demand of 37.5 MW. The TPP typically produces 4 to 5 MW of the operating power demand through the use of the STG. The majority of the power required at Deer Island comes through the cross-harbor marine cable to the main switchgear building. Two outdoor 13.8KV-480V transformers provide station service to the TPP. When in operation, the CTGs and the STG feed power to the DITP grid, synchronized through the TPP control room.

Due to the critical nature of the treatment plant operations, on-site power generation is an integral element of plant operations. Personnel trained in the cold-start procedures for the CTGs and STG staff the Thermal Power Plant around the clock. These units are also run on a routine basis during certain high-energy usage periods for electrical peak shaving. There are also electricians, plumbers, and mechanics that are present on-site, or are on-call during all holidays and off-hours. To minimize the potential downtime in the event of power failure, on certain occasions an electrician is required to be on site. DITP management calls for certain staff to be on-site whenever the overall plant flow exceeds certain limits (usually during high wastewater flow periods during severe weather).

FIGURE 6-10
Thermal Power Plant Process Flow Diagram

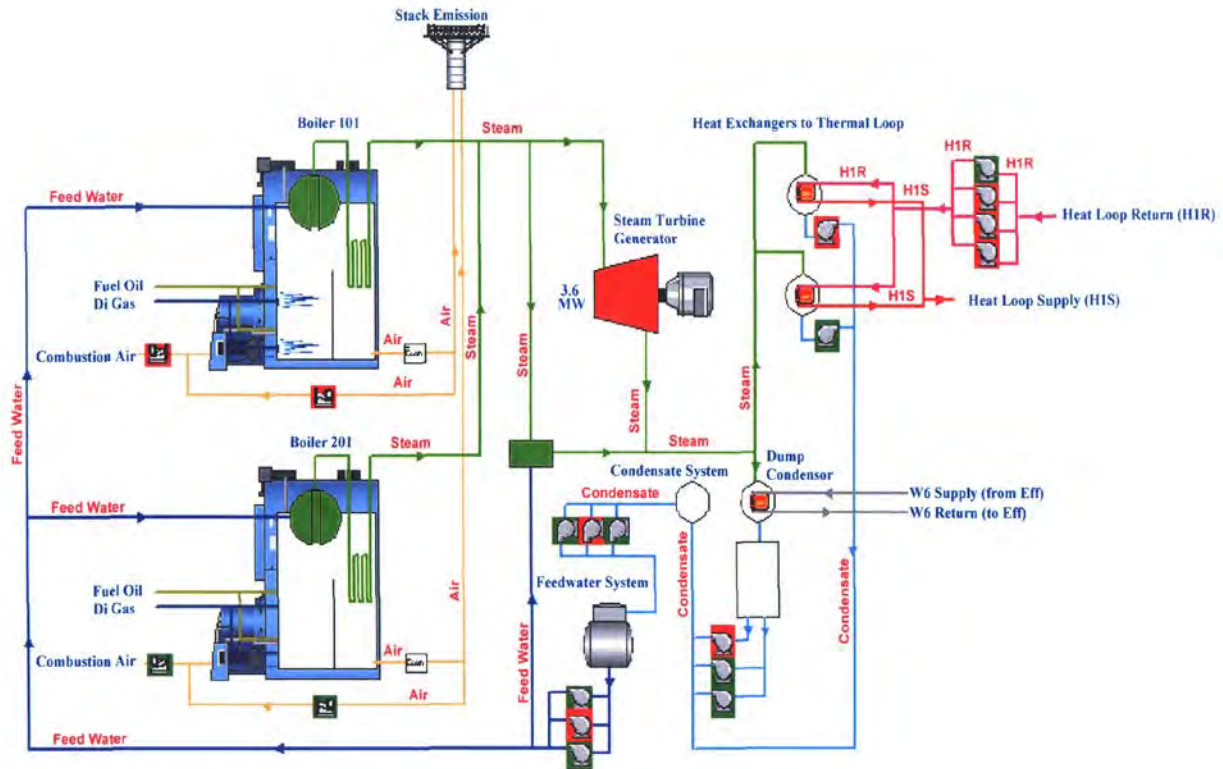

Facility Components: Two high-pressure boilers (manufactured by Zurn) are each capable of supplying 150,000 lbs/hr of steam at 620 psig and 750 degrees F. The boilers are capable of burning No. 2 fuel oil, sweetened digester gas, or a combination of the two. Combustion gases exhaust from the boilers to a dual flue steel stack with an exit height of 150 feet. The boiler system is used primarily to supply the DITP's thermal requirements and secondarily to supplement its electrical power load (via the STG). After the high-pressure steam passes through the STG or a dump condenser, the pressure is decreased and the low-pressure steam is used for other heating processes. Two heat exchangers transfer heat from the low-pressure steam system to a high-temperature water loop. The high temperature water loop is the major component of the Central Plant heating system and supplies the DITP's thermal requirements. Water from the hot return line loop is reheated through the high temperature water heat exchangers and sent to the hot supply line loop, from which it is used for treatment processes and heating in all of the other buildings. In compliance with the DITP air permit, a continuous emissions monitoring system contains two sets of data acquisition computers and the various gas analyzers required to monitor the exhaust gases from the boilers.



The steam turbine generator (STG) system expands the high-pressure steam from the Zurn boilers to drive a turbine, which generates electricity to supplement power requirements at Deer Island. The STG system consists of an 18 MW steam turbine generator and a 1.1 MW backpressure turbine (added in 2011) and its required support elements. In the usual mode, the electrical energy produced by the STG is a byproduct of the heat energy produced for central plant heating. If the STG is out of service for maintenance, steam can bypass the STG and pass through a pressure-reducing valve in order to feed the low-pressure steam loop. The 18 MW steam turbine is a 13-stage, impulse type, backpressure turbine manufactured by Siemens Demag Delaval KJMV. The generator is a two-pole, three-phase, water-cooled revolving field AC synchronous generator rated for 20,000 kVA. It is designed to operate at 3,600 rpm, providing 60 Hz of power at 13.8 kV. The 1.1 MW steam turbine is a single stage backpressure turbine; Siemens model SST-060. The generator is a three-phase, water-cooled revolving field AC synchronous generator rated for 1,311 kVA. It has a helical gear that reduces the speed to the generator to 1,800 rpm, and provides 13.8kV of electric power. Both STGs are controlled remotely from the power plant control room but also require some manual operation of valves at the turbine during startup and shutdown, as well as significant coordination of the plant support systems.

Two combustion turbine generators (CTGs) are used for backup electrical power supply in the event of loss of NSTAR power to DITP via the cross-harbor marine cable. The CTGs were supplied by Turbo Power and Marine Systems, Inc. (a Division of United Technologies Corporation). Each unit is a self-contained electrical generator powered by a combustion turbine. The CTGs have all the equipment necessary for local operation from each unit's control house and remote operation from the power plant control room. The system uses a Pratt & Whitney GG8 gas generator with a matching power turbine and an electric generator. The CTGs fire number 2 fuel oil, with a water injection system to control NOx emissions. The gas generator produces hot expanding gases that drive the power turbine. By coupling the power turbine to the electric generator rotor, 13.8kV utility-grade electric power is produced. Each CTG produces 26 MW of power at ideal conditions. The combustion gases exhaust through separate 10-foot diameter stainless steel stacks at exit heights of 90 feet. The main source of power to drive the auxiliary CTG equipment when the unit is running is an auxiliary step-down transformer rated 225kVA, 13.8 kV-480 V. A transfer switch is connected to a 480V feeder from the power plant station service system to provide power to the CTG auxiliary equipment when the unit is not running.

Recent Upgrades Completed:

- In FY11, STG system efficiency modifications were completed to increase electricity production through the addition of a 1.1 MW backpressure turbine.

Projects in the FY14 CIP and Future Recommended Upgrades:

- Transformer replacements are included within the Electrical Equipment Upgrade projects programmed in the FY14 CIP. Phase 4 Electrical Equipment Upgrades are programmed in the FY14 CIP at a cost of \$12.062 million during FY14-17 and Phase 5 Electrical Equipment Upgrades are programmed in the FY14 CIP at a cost of \$23.162 million during FY18-25. The plant includes 87 transformers (that have been in service an average of 13 years) that are replaced when they fail or when electrical testing indicates that failure is imminent. A Future Transformer Replacements placeholder budget is recommended for

consideration in future CIPs (every 5 years) at an estimated cost of \$1.5 million for each cycle and a target schedule of FY19, FY24, FY29, FY34, FY39, FY44, and FY49.

- Power System Improvements construction for modifications to Deer Island's electrical system to correct back-up power issues as recommended after an FY04 power outage is programmed in the FY14 CIP at a remaining cost of \$3.0 million during FY14-15. This construction project began in FY09.
- Thermal Power Plant (TPP) Fuel System Modifications (REI phase) is a project to provide resident engineering and inspection services during construction of certain power system improvements related to the TPP. This project is programmed in the FY14 CIP at a cost of \$800,000 during FY14-16.
- Thermal Power Plant (TPP) Boiler Control Replacement to eliminate obsolete equipment is programmed in the FY14 CIP at a cost of \$ 1.0 million during FY14-15.
- LOCAT Scrubber Replacement design and construction to replace the Thermal Power Plant's high-maintenance digester gas wet scrubber system with a dry scrubber system is programmed in the FY14 CIP at a cost of \$5.17 million during FY18-21. The LOCAT system scrubs hydrogen sulfide and other compounds from the digester gas. A future LOCAT Scrubber Rehabilitation/Replacement Project is recommended for consideration in future CIPs at an estimated cost of \$6.0 million during FY36-37.
- Combustion Turbine Generator (CTG) Rebuilds in the Thermal Power Plant is programmed in the FY14 CIP at a cost of \$6.0 million during FY17-20. Future CTG Rebuilds are recommended for consideration in future CIPs (every 15 years) at an estimated cost of \$3.0 million for each cycle with a target schedule of FY30 and FY45.
- Steam Turbine Generator (STG) Replacement at Deer Island is a project to evaluate and consider installation of more efficient equipment. This project is recommended for consideration in future CIPs at an estimated cost of \$3.5 million for a 3-year project duration during FY18-20.
- Future Heat Loop Pipe Replacement design and construction to continue upgrades/improvements to heat loop piping (prior phases 1, 2, and 3 complete) are recommended for consideration in future CIPs (every 15-20 years) at an estimated cost of \$2.0 million for each cycle and a target schedule of FY20, FY35, and FY50.

Hydroturbine Generators

Facility Function and Operation:

Electricity is generated using the gravitational force of plant effluent as it drops down the outfall shaft after exiting the disinfection basins, just prior to discharge to the 9.4-mile effluent outfall tunnel. Treated effluent flows from the disinfection basins through two intake channels into the Hydroturbine Generators (HTGs). The Hydropower Facility was commissioned in July 2001. The hydroplant piping arrangement is shown on Figure 6-11.

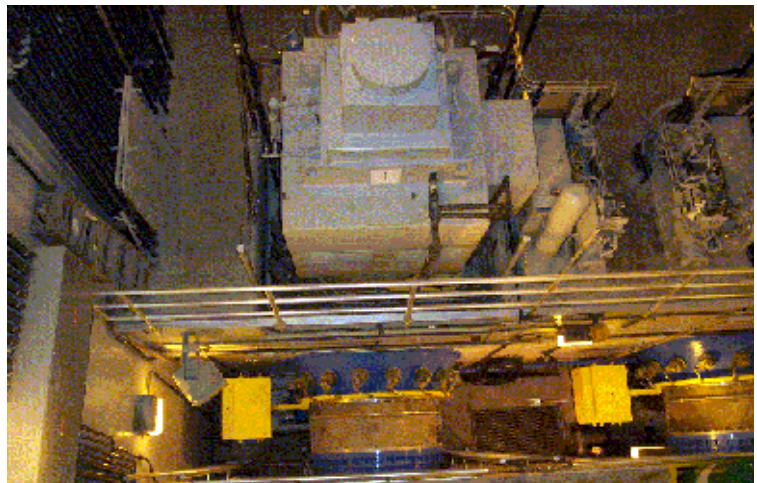

Facility Components: There are two 1.1 MW HTGs in the Hydropower Facility at Deer Island. The HTGs are horizontal (or slightly inclined) axial flow turbines in a bevel gear bulb configuration. The generators are driven through right-angle drive speed increasers, located in the pit or “bulb” at the upstream end of the turbines. The synchronous generators are vertically mounted on top of the speed increasers. The turbines are Kaplan type with adjustable runner blades and wicket gates. A programmable logic controller (PLC) controls flow through the HTGs. The PLC sets the wicket gate position to maintain an upstream water level in the north end of the disinfection basins. Flow in excess of the HTG capacity (or when the HTGs are shut down) passes over weirs and discharges directly into the outfall chute. When in use, the two HTGs discharge effluent into the turbine effluent conduit that joins the outfall chute and discharges into the effluent outfall tunnel. The downstream water level constantly varies with the ocean tides and plant flow. The difference between the upstream water level and downstream water level is the net head. The PLC calculates the runner blade position based on the wicket gate position and net head, to achieve maximum turbine efficiency.

Recent Upgrades Completed:

- In FY06-07, new Teflon coated wicket gate bushings were installed on the two HTGs to replace the ones that had rusted and were no longer adjustable. There have been no further problems or work other than routine maintenance performed on the HTGs since that time.

Future Recommended Upgrades:

- Future HTG Rehabilitation is recommended for consideration in future CIPs (every 20-25 years) at a cost of \$2.0 million each cycle with a target schedule of FY25 and FY45.

FIGURE 6-11

HYDROPLANT ARRANGEMENT

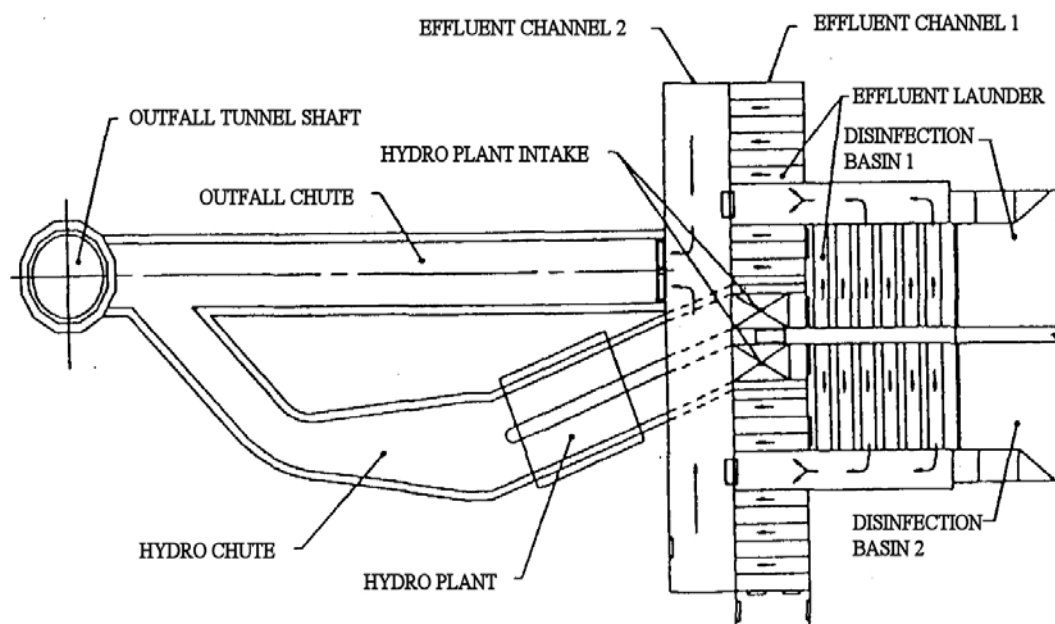

Wind Power

Background on Wind Power Development at Deer Island:

As part of MWRA's comprehensive energy strategy during the past several years, MWRA has explored numerous opportunities to reduce energy costs and increase renewable power, thereby reducing operating costs. MWRA staff worked with Black & Veatch under the direction of, and with funding provided by, the Massachusetts Technology



Collaborative on a wind power feasibility study. Black & Veatch performed an initial evaluation of a potential on-site wind energy project at DITP, located within the fence line of the plant. This included the estimation of wind resources (including a review of the wind data generated by the Renewable Energy Research Lab), addressing land use and obstruction issues, reviewing the plant's electrical infrastructure and load profile, identifying possible permit requirements, and a financial analysis. Black & Veatch also recommended future activities for developing wind power projects. While parts of the Black & Veatch study were similar to the Renewable Energy Research Lab work, it was a more detailed assessment and a necessary phase of the technical requirements associated with continued project support from the Massachusetts Technology Collaborative. Results from the study included:

- Identification of three possible sites that could support a wind energy project that could consist of up to four or more turbines, depending on the size selected;
- Confirmation that the DITP's electrical infrastructure and consumption would make an on-site wind energy project feasible; and,
- Production estimates for various turbine types, heights and locations are classified as having "good" capacity factors.

Facility Function and Operation: In November 2009 two horizontal axis 600kW wind turbines were installed in the south parking lot at Deer Island (shown in photo above). The turbines are manufactured by Vestas RRB India Limited, model Pawan Shakthi 600kW (referred to as PS600). The wind turbines are connected to the Deer Island electrical grid and directly off-set plant electric demand. The turbines are qualified as Class I MA Renewable Portfolio Standard facilities and MWRA earns revenue from the Renewable Energy Certificates (green attribute) sold.



In April 2011 an engineering prototype wind turbine was designed and installed at Deer Island, near the outfall tunnel shaft, by a MA based company FloDesign Wind Turbine Corporation (shown in photo at left). The wind turbine is rated at 100kW and is also directly connected to Deer Island's electrical grid, thereby further off-setting plant demand. Since the turbine is an engineering prototype it may not be operating continuously, as the FloDesign Wind engineers make modifications and adjustments to the wind energy system. This turbine design is considered a "Mixer Ejector Wind Turbine," a shrouded, axial-flow wind turbine, that is claimed to be capable of delivering three times more energy per unit swept area with greatly reduced rotor loading as compared to existing Horizontal Axis Wind Turbines.

Current plans are underway for development of a fourth wind turbine at DITP. The selected location is the area where the former Construction Support Building was demolished. Staff anticipate FAA approval for this wind turbine in spring 2012 and, contingent upon funding assistance, a contract for the design, purchase, and installation of this wind turbine could begin as early as FY13. Grant funding will be sought to help off-set design and construction costs. The turbine at this location would be a horizontal axis design of up to 600kW, similar to the parking lot wind turbines.

Projects in the FY14 CIP and Future Recommended Upgrades:

- Wind Power projects programmed in the FY14 CIP and recommended for future consideration are included in the Wastewater System Master Plan Chapter 13 – Energy Management, Information Management and Laboratory Services.

Solar Power

Facility Function and Operation: Solar photovoltaic systems are currently installed at Deer Island on the roofs of the Residuals/Odor Control (100kW), Maintenance/Warehouse (180kW) and Grit Buildings (222kW) and on the ground in the south parking lot (234kW). The solar panels on the grit building and on the ground were installed under a twenty year "power purchase agreement". MWRA staff are working with a solar energy consultant to conduct a comprehensive solar feasibility study for all MWRA sites, to assess the solar capability, and technical and economical feasibility.



The solar panels are a passive energy source; there is no need for maintenance other than occasional cleaning of the panels. The energy produced is supplied directly to the DITP grid and offsets the total plant demand.

Projects in the Existing FY14 CIP and Future Recommended Upgrades:

- Solar Power projects programmed in the FY14 CIP and recommended for future consideration are included in the Wastewater System Master Plan Chapter 13 – Energy Management, Information Management and Laboratory Services. The life expectancy for existing solar panels is approximately 25 years. No future CIP projects are anticipated for the installation of solar panels because future solar construction projects are likely to be “power purchase agreements” where a Contractor is selected to install solar panels and the MWRA pays a set rate per kWh for the produced energy from CEB funds.

Electrical Distribution

Facility Function and Operation: The electrical distribution system is comprised of various switchgear and unit substations in a secondary selective system. This type of system allows two separate main busses of a double-ended unit substation to be connected to each other through normally open bus tie circuit breakers. The benefit of this system is that if a primary cable or transformer fails and an upstream circuit breaker opens, the bus tie breaker would close and re-energize the affected electrical equipment. The electrical distribution system is designed to function with all five sources of DI electric power: cross-harbor marine cable (NSTAR), Thermal Power Plant on-site generation, Hydropower Facility on-site generation, Wind Turbine on-site generation, and Solar on-site generation. The connection of all generating sources to the electrical distribution system are supervised by synchronizing equipment and feed power through the main plant switchgear. The synchronization equipment ensures that the power generated is in phase and voltage range with the power supplied by NSTAR.

Facility Components: The electrical distribution system primarily consists of the main switchgear building, 13.8 kV switchgear, unit substations, duct banks, cables, and associated equipment to provide power to all DITP facilities. The main plant switchgear splits the electrical power into two separate, parallel feed systems, which provide redundant power distribution throughout the plant. The 13.8kV main switchgear located in the main switchgear building consists of two redundant sets of switchgear connected through normally open bus tie circuit breakers and bus duct. Circuit breakers and various protective relays are located within the switchgear. The circuit breakers supply power to the various substations situated throughout Deer Island. At the switchgear are protective relays that indicate instantaneous current, time over-current, ground fault, and under voltage conditions, which protect the electrical system. The breakers are electrically interlocked to prevent inadvertent or improper operation.

To maintain a redundant power system throughout the electrical distribution system, two separate 15 kV-rated cable systems (“A” and “B”) are located in separate, buried, reinforced concrete ductbank and manhole systems that are tied directly to the DITP electrical substations. The underground medium voltage ductbank system typically consists of 5-inch Schedule 40 PVC conduits. The "A" and "B" ductbank systems run parallel to each other from the main switchgear building using cable which is shielded, stranded, and 500 kcmil single conductor per phase.

The 13.8kV switchgear at the Thermal Power Plant consists of three buses ("A" bus, "B" bus, and "C" swing bus). The "A" and "B" buses are each connected to a combustion turbine generator while the "C" swing bus is connected to the steam turbine generator. The buses are connected with bus tie circuit breakers to allow the steam turbine generator to supply power to either the "A" or "B" side of the power distribution system. The wind turbines are connected to the electrical distribution system at substation 21 on the pier. The solar arrays are tied into other substations closest to where they are located. No personnel involvement is required to synchronize the power supply from these units into the electrical system.

The Residuals Process Area 13.8kV switchgear is an extension of the DITP main switchgear dual-bus system. It is powered from the main switchgear via the medium voltage ductbank and cable system and is comprised of an "A" and "B" bus with a normally open bus tie breaker. Feeder circuit breakers at the residuals switchgear distribute 13.8kV power to the unit substation transformers located in the Residuals Process Area.

Unit substations consist of primary fused switches connected to a 13.8kV transformer primary. The secondary at each substation transformer feeds a 480-volt or 4,160-volt switchgear bus via an incoming line breaker. Each bus has circuit breakers to power various DITP loads. Each unit substation in the electrical distribution system, with the exception of the substation at the Pilot Plant and the Hydro Power Facility, has two primary 13.8kV transformer primary feeders: one from main switchgear bus "A" and one from bus "B", making the substations "double-ended". Normally, each double-ended substation operates with a primary cable terminated to a closed fused switch at the transformer primary. The secondary of each transformer is connected to closed incoming line breakers (the bus-tie breaker is normally open). The substations are designed such that, with the controls in the proper position, a loss of power on either the "A" or "B" bus will result in an automatic bus transfer or the re-energization of the affected bus through the bus tie breaker.

Most process areas are operated at 480 volts. However, several process areas, such as the North Main Pump Station, Winthrop Terminal Facility, South System Pump Station, and the Central Blower Facility, have large motor loads. The medium voltage motor control centers of these process areas are operated at 4,160 volts. At 4,160 volt substations, additional substations are provided to reduce system voltage to 480 volts to provide station service power. The Pilot Plant and the Hydropower service substation are single-ended substations and thus are only powered from the main switchgear bus "A" (Pilot Plant) or bus "B" (Hydropower Facility).

Recent Upgrades Completed:

- As part of DITP's on-going program to replace transformers and bus ducts at the end of their useful lives, electrical equipment upgrades have been made over the last 10+ years.

Projects in the FY14 CIP and Future Recommended Upgrades:

- DI Electrical Equipment Upgrades Phase 4 REI and construction is programmed in the FY14 CIP at a cost of \$12.062 million during FY14-17. Design packages have been completed.
- DI Electrical Equipment Upgrades Phase 5 is programmed in the FY14 CIP at a cost of \$23.162 million during FY18-25.

- Future Electrical Equipment Upgrades (beyond Phase 5) to replace transformers and bus ducts is recommended for consideration in future CIPs (annually) at an estimated cost of \$700,000 annually and a target schedule from FY21 through FY53 for a total cost of \$23.1 million projected over 23 years.
- Switchgear Replacements design and construction to sequentially replace obsolete electrical switchgear throughout the DITP is programmed in the FY14 CIP at a cost of \$5.797 million during FY16-20.
- Switchgear Replacements Phase 2 design and construction to continue upgrades to electrical switchgear throughout the plant is programmed in the FY14 CIP at a cost of \$20.5 million during FY17-21.
- Future Switchgear Replacements design and construction (beyond Phase 2) to upgrade/replace electrical switchgear is recommended for consideration in future CIPs (every 10-15 years) at an estimated cost of \$10 million in each cycle with a target schedule of FY30, FY40, and FY50.

Energy Management

MWRA's energy management planning applies to both the water and wastewater systems. For convenience of the reader and organization of the Wastewater and Water System Master Plans, energy management is detailed in both Chapter 13 of the Wastewater System Master Plan, as well as, Chapter 10 of the Water System Master Plan. Many of the energy management recommendations are policy items or relatively low cost projects. Larger cost projects are typically included within the Water or Wastewater Master Plan Chapter related to the specific asset being addressed. For example, a project to replace the Deer Island steam turbine generator (STG) with more efficient equipment is recommended (and costs included) earlier in this Chapter within the Subsection on the Thermal Power Plant. A future project to construct additional wind turbines at Deer Island is included in Chapter 13.

6.12 Odor Control Facilities

Odor control facilities at DITP are located in four buildings. The North Main Pump Station houses the North Odor Control Facilities that treat exhaust gases from the NMPS and WTF operations. The South System (Lydia Goodhue) Pump Station and the Grit Facility are adjacent to the East and West Odor Control facilities, which treat exhaust gases from those two buildings as well as the primary treatment process. The Residuals Odor Control Facility treats exhaust gases from the various residuals processing facilities. The odor control technology used includes packed tower wet scrubbing for removal of total reduced sulfur compounds and volatile organic compounds, followed by carbon adsorption, if required.

Facility Function and Operation: The function of the odor control facilities is to treat off-gases collected in the treatment process, resulting in stack emissions meeting MassDEP air emissions permit limits. The odor control facilities are designed to control concentrations of hydrogen sulfide and total reduced sulfur to levels below 1.0 ppm measured in stack emissions. The scrubber systems are designed for a minimum hydrogen sulfide removal efficiency of 99 percent at inlet hydrogen sulfide concentrations above 5.0 ppm. Two redundant scrubber trains are provided at the

North Main Pump Station, one scrubber train is provided at the South System Pump Station and the Residuals Odor Control Facility.

Facility Components: The odor control trains have two-stage wet scrubbers followed by carbon absorbers. Centrifugal exhaust fans draw air through the wet scrubbers and then blow it through heating coils and carbon absorbers before it is discharged back to the atmosphere through the stack. Separate chemical storage tanks are provided for each odor control train.

The wet scrubbing system uses sodium hypochlorite and sodium hydroxide for control of hydrogen sulfide and other inorganic odor causing compounds. Three wet scrubbers are provided for each flow stream, with two usually operating in series and one as standby. The wet scrubbers are packed towers, in which the air stream enters the bottom of the tower and flows upward, while the scrubbing liquid is distributed across the top of the packed bed and flows downward. This counter-current contacting of scrubber solution and odorous air ensures that the odorous gases are absorbed and/or oxidized by the scrubbing solution. Treated gases drawn out of the tower are sent to either the next scrubber in series or to the carbon adsorption system. The scrubber solution is collected out of the bottom of the tower and recirculated to the top of the tower for reuse. A percentage of the scrubber solution is wasted to a floor drain where it flows in acid-resistant piping to the sanitary system. Wasting ensures that fresh chemical will be entering the scrubber system at all times. The make-up water flow rate controls the wasting rate.

Separate chemical storage tanks are provided for each odor control train. Color-coded chemical fill stations are located near the truckway doors, one for sulfuric acid and one for the sodium hydroxide. The fill ports also have different connectors, so only the correct chemical hose can be connected. The sodium hypochlorite tanks are filled from the plant hypochlorite system. Metering pumps feed the various chemicals into the associated scrubber recirculation loop.

Air from the wet scrubbers is heated to reduce the relative humidity and minimize condensation in the carbon adsorption units, which impedes the airflow. The carbon adsorption vessels are horizontal steel tanks, lined with corrosion-resistant material. There are several different vessel sizes that hold varying amounts of carbon, allowing for some operational flexibility. The vessels contain a bed of granular activated carbon several feet thick. The air flows through the carbon bed with the carbon adsorbing VOCs, hydrogen sulfide and other odorous compounds in the air stream. Eventually, the carbon becomes saturated with these compounds and less efficient at removal. Tests are periodically run on air samples (taken from sample ports located on the side of the vessels at different bed depths), to determine when the carbon is saturated and needs to be changed out. Spent carbon is sent to a carbon regeneration facility to be reprocessed for reuse. The carbon adsorption units may also be used exclusively (bypassing the wet scrubbers) if the odorous compound levels are low and it is more cost efficient.



Facility Power: The odor control facilities are powered through a substation with two 13.8kV-to-480V transformers. The Thermal Power Plant provides back-up power.

Recent Upgrades Completed:

- Ten carbon adsorbers that had internal steel deterioration were repaired (if needed) and coated in FY10, the remainder are scheduled to be rehabbed in FY12-13 under the CEB.

Projects in the FY14 CIP and Future Recommended Upgrades:

- Ancillary Modifications Final Design and Construction 4 for modifications to the cryogenic facility, plant-wide odor control systems, digester gas, and scrubber improvements are programmed in the FY14 CIP at a cost of \$15.124 million during FY15-21.
- DI HVAC Equipment Replacement design, ESDC, and construction to replace odor control and air handler equipment (including DITP Laboratory fume hoods) is programmed in the FY14 CIP at a cost of \$20.6 million during FY14-20.
- DI East/West Odor Control Air Handler Replacement – Future is programmed in the FY14 CIP at a cost of \$2.0 million during FY25-30.
- Future DI Odor Control Air Handler Replacement is recommended for consideration in future CIPs (every 15 years) at an estimated cost of \$3.0 million for each cycle with a target schedule of FY30 and FY45.

6.13 Additional Support Systems

Additional support systems and utilities required for DITP operation are detailed in this Section, including: Process Instrumentation and Control System; Department of Laboratory Services; building HVAC control systems; fuel oil facilities; chemical handling systems; water systems; sanitary and stormwater systems; personnel protection systems; and records management.

Process Instrumentation and Control System

Facility Function and Operation: DITP's Process Instrumentation and Control System (PICS) is a modern industrial distributed control system. It is the primary interface used by Operations staff to control wastewater treatment and power plant processes at DITP. PICS provides overall plant-wide process automation and control as well as centralized monitoring for Deer Island staff, enabling operation of facilities with a minimum of off-shift staffing. Process data from PICS is available throughout MWRA via the MIS networked DITP Process Information Archive (PI), which is set up to show current and historic operational data on all of the major functional areas of DITP. This system is essential for environmental compliance reporting and plant optimization efforts. Operation of PICS commenced in January 1995 with the start-up of the new primary treatment process. Since then, PICS has expanded as additional process units have been brought on-line.

Facility Components: The system was installed as part of the Boston Harbor Project under the Process Instrumentation and Control System Contract for the Treatment Plant and the Thermal/Power Plant Contract at a cost of approximately \$24 million. The PICS system consists of 29 Operator Consoles, 64 field cabinets containing electronic control equipment, and multiple engineering workstations for system modifications. All PICS equipment is networked together by a

redundant plant-wide fiber-optic data transmission loop. Overall there are approximately 35,000 input/output points monitored and/or controlled through PICS.

Projects in the FY14 CIP and Future Recommended Upgrades:

- DI PICS Distributed Processing Units (DPU) Replacements to replace the distributed processing unit cabinets and internal components of the PICS system is programmed in the FY14 CIP at a cost of \$8.0 million during FY22-23. This 2-year duration project is also recommended for consideration in future CIPs (every 20 years) at an estimated cost of \$4.0 million beginning in FY42.
- DI PICS Replacement Construction to replace obsolete hardware components of the Process Information Control System is programmed in the FY14 CIP at a cost of \$5.49 million in two separate phases (each 1-year projects) scheduled for FY15-16 at \$90,000 and FY22-23 at \$5.4 million. Future PICS Replacement Construction is also recommended for consideration in future CIPs (every 15 years) at an estimated cost of \$2.0 million for each cycle with a target schedule of FY37 and FY52.

Department of Laboratory Services

MWRA's Department of Laboratory Services are client based. Clients include Deer Island, ENQUAD, TRAC, Drinking Water Programs, and member communities. To accommodate the range of laboratory services needs, the geographic range of the MWRA system, and types of samples to be analyzed; MWRA operates laboratory facilities in Chelsea, Clinton, Quabbin, Southborough, and the Central Lab at DITP.

MWRA's Laboratory Services serve both water and wastewater needs and are fully detailed in Wastewater System Master Plan Chapter 13 – Energy Management, Information Management, Laboratory Services, and Security as well as, Chapter 9 of the Water System Master Plan. Costs for Laboratory Services projects (water and wastewater) programmed in the FY13 CIP and/or recommended for future CIPs are included in Chapter 9 of the Water System Master Plan. There is one project included in the DITP costs (as part of DITP Odor Control and HVAC Control Systems) that includes work involved with DITP central laboratory fume hoods, as noted below:

Projects in the FY14 CIP

- DI HVAC Equipment Replacement design, ESDC, and construction to replace odor control and air handler equipment (including DITP Laboratory fume hoods) is programmed in the FY14 CIP at a cost of \$20.6 million during FY14-20.

Building HVAC Control Systems

The DITP has two HVAC Building Management Control Systems which were made by different manufacturers (one by Siemens, and one by Johnson Controls); both were installed under different construction contracts as part of the BHP. The two HVAC systems control the heating and cooling in the majority of buildings on Deer Island. Both control systems are obsolete and staff have attempted to replace electronic components piecemeal, as they fail. In addition, the two existing systems do not have the ability to communicate with each other. For consolidation of parts and service and to allow the entire system to communicate to better monitor and control the cooling and

heating systems; staff recommend that the two HVAC control systems be replaced with one from a single manufacturer. The system is likely to need replacing every 15 to 20 years.

Projects in the FY14 CIP and Future Recommended Upgrades:

- DI HVAC Equipment Replacement design, ESDC, and construction to replace odor control and air handler equipment (including DITP Laboratory fume hoods) is programmed in the FY14 CIP at a cost of \$20.6 million during FY14-20.
- Future DI HVAC Upgrades/Replacement including the control system, fan coils, etc. is recommended for consideration in future CIPs (every 15 years) at an estimated cost of \$20.0 million for each cycle and a target schedule of FY30 and FY45.

Fuel Oil Facilities

Facility Function and Operation: The plant-wide fuel oil system was designed to supply #2 fuel oil to the two combustion turbine generators (CTGs) and supplemental fuel to the Zurn boilers in the Thermal Power Plant. Deliveries by tank truck are currently the least-cost option, so fuel is off-loaded directly at the fuel storage tank area. When the fuel oil facilities were originally constructed, fuel oil deliveries were primarily made by barge, off loaded at the pier facility, and pumped to fuel storage tanks. However, the fuel pipeline was tested and could no longer maintain adequate pressure, indicating that there was a potential internal leak in the piping. Approximately 3,000 feet of double-walled piping system from the pier to the fuel storage tanks located north of the Thermal Power Plant was filled with concrete and abandoned in place in FY12.

Facility Components: The fuel storage area consists of two 750,000-gallon storage tanks, a tank gauging system, truck unloading station, and containment area. The two tanks are carbon steel, equipped with ladders on both the outside and the inside of the tanks. The fuel tanks hold a 10-day supply of fuel oil based on both an emergency electric load and the January 1999 heating load.

The fuel oil supply piping is routed from the fuel oil transfer pumps to the Thermal Power Plant where it feeds the two CTGs and two boilers. The Thermal Power Plant is equipped with a fuel oil head tank for each CTG, to ensure enough fuel is available to start the CTGs in a power outage when fuel pumping is not possible. Fuel is pumped from the storage tanks directly to the CTGs while maintaining a full level in the head tank. Each fuel pump discharge line has a pressure relief valve, so if the line is over-pressurized it will be relieved to one of the storage tanks. Fusible-link gate valves are installed in the fuel oil piping as it enters and exits the Thermal Power Plant. These emergency gate valves close when the piping reaches a predetermined temperature, to ensure that oil will not be pumped into a burning building. These valves must be replaced after actuation.

The fuel containment area consists of continuous, reinforced concrete slab with walls of a minimum height of 10-feet designed to contain 100 percent of one tank plus 10 percent of the second tank in accordance with Massachusetts regulations. The containment area has a sump to collect rainwater and any oil spills/overflows. The sump flows by gravity into an oil-water separator prior to discharging to the storm drain system. An 8-inch gate valve is installed on the sump discharge line prior to the oil water separator and is opened or closed manually.

Future Recommended Upgrades:

- DI Future Fuel Supply Pump and Pipe Replacement or Rehabilitation design and construction is recommended for consideration in future CIPs (every 20 years) at an estimated cost of \$5.0 million for each cycle with a target schedule of FY42. This project has an estimated duration of 2-years.

Chemical Handling Systems

Facility Function and Operation: Every chemical off-loading area has specific chemical handling procedures and protocol. The pipe connections are often specially suited for each application and/or color-coded for safety reasons. Each contract specification has chemical delivery instructions, as well as a general section addressing chemical safety. Operations staff involved with chemical handling have all been trained in off-loading procedures and personnel safety apparatus. Chemical delivery trucks are escorted to the proper off-loading location as needed, and DITP staff oversees and, in some cases, assist with the transfer operation if any valves or pumps need to be operated. If the chemical is not easily identified, samples are taken to ensure that the chemical conforms to the expected parameters. Sodium hypochlorite is delivered by truck and pumped directly into the storage tanks. Previously, sodium hypochlorite had been delivered by barge and pumped through nearly a mile of piping to the storage tanks. Truck deliveries have become more cost effective due to the high cost for barging.

Projects in the FY14 CIP and Future Recommended Upgrades:

- Chemical Pipeline Replacement design and construction for planned periodic replacement of various chemical pipelines in the disinfection and odor control facilities due to deterioration from corrosion is programmed in the FY14 CIP at a cost of \$2.757 million during FY16-19. Future Chemical Pipeline Replacement/Upgrade design and construction is also recommended for consideration in future CIPs (every 20 years) at a cost of \$500,000 for each cycle with a target schedule of FY33 and FY53.
- Leak Protection System Upgrade to the leak protection system and chemical/fuel tank containment areas is recommended for consideration in future CIPs (every 15 years) at an estimated cost of \$500,000 for each cycle with a target schedule of FY15, FY30, and FY45. This project has an estimated duration of 1-year.

Water Systems

Facility Function and Operation: The plant-wide potable water (W1) and service water (W2) system consists of a water storage tank and a piping network which conveys water throughout DITP for fire pumps, fire hydrants, emergency eye wash and showers, lavatory facilities, wash-down hydrants, seal water, and all other potable and non-potable services supporting plant operations. The W1 system is fed by a 24-inch dedicated distribution main from the MWRA's Northern High System. The 24-inch line provides water to the 2-million gallon elevated water tank on the north end of the Island. Two 20-inch lines provide redundant connection from the water tank to the 16-inch W1 loop, which circles the plant area. Each DI facility is fed from a connection to the 16-inch plant loop. The sizes of the connections vary from 4-inch to 8-inch depending upon the demand of each facility. The W1 system services all potable water requirements as well as the DITP service water

system. The W2 system is separated from the W1 system by backflow preventers and provides clean water at hose gates, hot service water, and seal water.

High and low pressure plant process water (W3H and W3L) systems distribute disinfected plant effluent to flushing connections, carrier water connections, hose gates, cooling water, primary sludge dilution water, and foam spray systems throughout the plant. The systems use dedicated piping networks, which are not used by any other plant systems. Both systems draw suction through a common header from the outfall by-pass conduit located beneath the disinfection gallery. The W3H system has variable-speed, split case centrifugal pumps. The W3L system has both variable-speed and constant-speed split case centrifugal pumps. The W3H and W3L system design flow rates are 7,500 gpm and 16,500 gpm, respectively.

Projects in the FY14 CIP and Future Recommended Upgrades:

- DI Water Storage Tank Cleaning/Rehabilitation and Water Pipeline Rehabilitation are recommended for consideration in future CIPs (every 40 years) at an estimated cost of \$2.0 million for each cycle with a target schedule of FY40. This project has an estimated duration of 2-years.
- W3H Flushing System Pipeline Replacement (as part of the Clarifier Rehabilitation project) due to deterioration from corrosion is programmed in the FY14 CIP at a remaining cost of \$71,000 during FY14. The project began in FY13 and will be complete in FY14.
- DI Cathodic Protection Testing is recommended for consideration in future CIPs (every 10 years) at an estimated cost of \$250,000 for each cycle with a target schedule of FY15, FY25, FY35, and FY45. This project has an estimated duration of 1-year.

Sanitary and Stormwater Systems

Facility Function and Operation: The sanitary system for DI has been subdivided into three categories: sanitary lines, sump pump discharge lines, and chemical-resistant waste piping. The sanitary lines convey sewage from lavatories, service sinks and floor drains of the various facilities on Deer Island through a gravity system to the Winthrop Terminal Facility for treatment. The piping varies in size from 8-inch to 30-inch and consists of ductile iron, reinforced-concrete, or PVC. A number of sewage ejector pumps, used to lift sanitary waste to an elevation such that it can be discharged into a gravity sewer, are located throughout DITP. The galleries and basements of various structures have a gutter and floor drain system to collect spills, discharge from sampling equipment, and wash down water. Sump pumps located at intervals throughout the plant discharge to the sanitary system.

Chemical-resistant piping is provided at the North Main Pump Station, Administration/Laboratory Building, East and West Odor Control Facilities, Gas Handling Facility, Operation Center and Odor Control Facility. These lines handle chemical wastes generated in the DITP laboratory and odor control facilities. The chemical-resistant waste piping conveys chemical wastes from a source to a point in the sanitary system where the chemical is either neutralized or sufficiently diluted with other sanitary flow.

The DI stormwater drainage system is divided into sixteen drainage areas. Runoff collected from fourteen of the drainage areas is routed to an oil/water separator which removes oils, floating debris, and grit before the storm water is discharged into Boston Harbor. Surface runoff from the vegetated areas of the northeast slopes of the Northern Landform and the southeast slopes of the Southern Landform are allowed to drain naturally to the harbor. The gravity drainage system consists of reinforced concrete and PVC drainage pipe that transports storm water collected in catch basins to the discharge points. Two storm water pump stations, constructed in low lying areas, lift the storm water to a sufficient grade for tie-in to the gravity drainage system. One pump station is located in front of the Reception/Training Building; the other is located in the Residuals Area on Road 9. Prior to developing the standards for the DI stormwater drainage system, a number of single compartment oil/water separators were installed. These units are mainly in the pier and roadway areas to protect the harbor from direct discharges of oil in the event there is a spill or oil leaks from vehicles.

Future Recommended Upgrades:

- DI Future Sanitary and Stormwater System Rehabilitation including replacement of ejector pumps and rehabilitation of force mains and gravity pipelines is recommended for consideration in future CIPs (every 20-25 years) at an estimated cost of \$1.0 million for each cycle with a target schedule of FY25 and FY45. This project has an estimated duration of 2-years.

Personnel Protection Systems

Facility Function and Operation: Personnel protection systems on DI are those systems whose function is to provide security, protection, monitoring, and communication capability to DI staff and to emergency service personnel who may enter the DITP from time to time. There are six plant-wide personnel protection systems: fire alarm, page/party, private branch exchange (telephone), radio, card access, and closed circuit TV.

Maintenance staff routinely tests the DITP fire alarm system that has been in operation for over fifteen years. It is one of the largest fire systems in a single facility in MA and consists of over 2,000 separate points and 57 fire alarm monitoring panels. The local Fire Alarm Monitoring Panels contain circuit boards that are obsolete and staff cannot obtain spare parts. The front end of the system (the main PC which controls the system and the monitors) also requires replacement. Staff will need to replace the fire monitoring system including all pull boxes, strobes, horns, smoke and heat detectors. There are smoke detectors in most of the ductwork throughout the plant. The National Fire Protection Association (NFPA) recommends replacement of duct smoke detectors every 10 years to ensure proper operation of the system. These duct smoke detectors are to be replaced over several years as a CEB-funded project. The fire monitoring system is likely to need replacing every 15 to 20 years.

The card access system feeds data to a DITP database, and the closed circuit TV images are digitally recorded. There are annual CEB maintenance contracts in place for the closed circuit TV hardware and software, the card access system, and the telephone/page party systems.

A chain link fence surrounds the entire treatment plant, with approximately 10 access gates along the perimeter of the plant. The majority of the access gates remain locked at all times. Two gates along the main access road also have concrete barriers in front of the gates to prevent unauthorized vehicle access or egress. One access gate allows primary access to the facility, at the Main Guard House. An annual Authority-wide security contract is in place with the contracted security personnel managing the daily traffic to and from the facility on a 24-hour, 365 days per year basis. Security staff use a card reader system to scan employees in and out; issue temporary access placards to authorized vehicles and persons; and observe the janitorial staff as they punch in and out at the Guard House. Members of the Security team also perform periodic inspections around the perimeter of the facility and inside certain buildings during the off-hours and holidays.

The DITP site includes seawalls for protection of the plant from storm tides and a pier/personnel dock. These facilities require routine maintenance and periodic repairs.

Recent Upgrades Completed:

- In FY10, the plant entrance at the main guard house was rebuilt. Permanently mounted card access readers, multiple closed circuit video cameras and hardened steel barrier gates were installed to monitor the gate activity and prevent unauthorized access to the plant in emergency situations.

Projects in the FY14 CIP and Future Recommended Upgrades:

- DI Fire Alarm System design, construction and REI to upgrade/replace the fire alarm system at the DI plant is programmed in the FY14 CIP at a cost of \$19.3 million during FY14-19.
- DI Future Personnel Protection System Upgrade/Replacement is recommended for consideration in future CIPs (every 10-15 years) at an estimated cost of \$1.0 million for each cycle with a target schedule of FY25, FY35, and FY45.
- DI Eastern Seawall Repairs design and construction to repair the eroded concrete seawall at Deer Island is programmed in the FY14 CIP at a cost of \$4.174 million in FY15-19. This project has a 4-year duration and will repair tidal damage and exposed rebar at the base of the Eastern Seawall.
- DI Future Seawall Refurbishment design and construction to repair seawall erosion and damage is recommended for consideration in future CIPs (every 10-15 years) at an estimated cost of \$2.0 million for each cycle with a target schedule of FY25, FY35, and FY45.
- DI Barge Berth and/or Pier Facilities Rehabilitation/Replacement is programmed in the FY14 CIP at a cost of \$2.265 million in two phases during FY14-15 and FY19. This 3-year duration project will provide major rehabilitation of the DI barge berth and pier facilities (including floats, ladders, aluminum gratings, etc.) resulting from normal wear and storm/tidal damage.
- DI Future Barge Berth and/or Pier Facilities Rehabilitation is recommended for consideration in future CIPs (every 20-25 years) at an estimated cost of \$2.0 million for each cycle with a target schedule of FY33 and FY53.
- DI Personnel Dock Rehabilitation Construction to repair the floats, ladders and aluminum grating of the personnel dock is recommended for consideration in future CIPs (every 15-20 years) at an estimated cost of \$2.0 million for each cycle with a target schedule of FY18, FY33, and FY48.

- DI Roof Replacement Phase 3 is programmed in the FY14 CIP at a remaining cost of \$1.156 million during FY14. This 2-year duration project will substantially complete roof replacements for major DI buildings which began in FY10 (phase 1) and continued in FY11 (phase 2). The Phase 3 project began in FY13.
- DI Future Roof Replacements is recommended for consideration in future CIPs (every 15 years) at an estimated cost of \$6.0 million for each cycle with a target schedule of FY25 and FY40. This project has an estimated duration of 3-years.

Records Management

Facility Function and Operation: The majority of the DI document collection is from BHP documents. In recent years, technical documents have been added into the DI document collection from the various construction contracts and in-house maintenance activities. These new document additions not only have increased the volume of the total technical document data at DITP, but also have required continuous update activities on the existing documents, such as making new revisions of existing drawings, modifying SOPs, and updating vendor manuals.

The Technical Information Center (TIC) at DITP manages the activities of maintaining existing documents, receiving and filing incoming documents, controlling distribution of new documents, and making revisions to existing documents based on incoming documents or new information. While responding to daily document requests from MWRA staff, TIC is also converting document formats to improve accessibilities, controlling a mixture of required security levels, increasing storage efficiency, and preserving original copies.

Projects in the FY14 CIP and Future Recommended Upgrades:

- DI Document Format Conversion project to convert DI construction documents into electronic format and complete the document-reference database is programmed in the FY14 CIP at a remaining cost of \$75,000 in FY14.

6.14 Summary of Existing and Recommended Capital Projects

All Master Plan projects related to the Deer Island Treatment Plant are summarized in this Section. Table 6-1 lists each project, its priority ranking, and the proposed expenditure schedule. A description and needs justification for each project is listed in bullet format. This Section is provided as a summary of all DITP projects in the existing FY14 CIP and future recommended capital projects; each project has been noted previously in the Chapter within Sections relating to specific facilities or asset types.

Projects in the Existing FY14 CIP: There are fifty DITP projects programmed in the FY14 CIP. The projects are described below and summarized in Table 6-1 (see line numbers 6.01 through 6.50).

- DI As-Needed Technical Design 7-1, 7-2, and 7-3 projects, used to supplement in-house engineering staff, are programmed in the FY14 CIP at a cost of \$3.923 million during FY14-16. The As-Needed Design contracts are task-order contracts with engineering firms that have multiple engineering disciplines (structural, civil, mechanical, electrical, chemical) as well as other technical consultants with expertise in fields such as hydrology, biology,

landscape design, architectural design, marine biology, etc. These resources are used to supplement the skills of in-house staff and provide assistance with developing specifications for various construction contracts needed to move DITP projects forward.

- DITP As-Needed Technical Design project that acts as a placeholder for CIP funds to be used as the As-Needed Contracts are developed is programmed in the FY14 CIP at a budget of \$2.0 million annually for FY16-26 with a total project budget of \$21.05 million.
- DI Equipment Replacement project provides a long-term placeholder budget for funding new projects and/or increases to existing projects for DITP equipment replacement. New projects or new subphases are deducted from the \$25.0 million placeholder budget programmed in the FY14 CIP during FY19-23.
- Future South System Pump Station Variable Frequency Drives (VFDs) Replacement design/construction is programmed in the FY14 CIP at \$24.0 in FY18-21.
- South System Pump Station Pump Lube System Replacement to change the pump lubrication system from the current system using grease to a new system using oil is programmed in the FY14 CIP at \$2.9 million in FY19-21. Once installed, the new system will require only routine maintenance, not replacement.
- North Main Pump Station VFD Replacements including design, ESDC, REI, and construction is programmed in the FY14 CIP at \$18.212 million in FY14-16. This project also includes motor replacements.
- Future North Main Pump Station design/construction to replace VFDs every 10-15 years is programmed in the FY14 CIP at \$22.1 million in FY22-25.
- North Main Pump Station Harmonic Filter Replacement is programmed in the FY14 CIP at \$3.0 million in FY19-21. This project is planned to be combined with the VFD replacements.
- North Main Pump Station Sequential Replacement of the Motor Control Center (MCC) that is currently obsolete and unreliable is programmed in the FY14 CIP at a total cost of cost of \$6.086 million in FY15-17.
- North Main Pump Station Replacement of the remaining nine of ten 60-inch butterfly valves for isolating pumps and Winthrop Terminal Facility Plug Valve Replacement is programmed in the FY14 CIP at a cost of \$10.0 million in FY14-16.
- Winthrop Terminal Facility design/construction to Replace VFDs that are currently obsolete and miscellaneous smaller VFDs throughout the DITP is programmed in the FY14 CIP at \$4.796 million in FY14-17.
- Future design/construction to Replace Additional Miscellaneous VFDs is programmed in the FY14 CIP at \$6.667 million in FY15-21.

- Expansion Joint Repairs construction 2 and 3 for Clarifiers and Retaining Walls will continue the ongoing program to periodically replace failed expansion joints in the concrete clarifier decks and/or various retaining walls. This project is programmed in the FY14 CIP at a cost of \$2.699 million during the FY14-18 timeframe.
- Clarifier Rehabilitation to replace deteriorated water flushing lines (W3H Flush System) is programmed in the FY14 CIP at a cost of \$71,000 during FY14.
- Clarifier Rehabilitation to replace scum skimmer tip tubes is programmed in the FY14 CIP at a cost of \$20.0 million during FY14-17.
- Clarifier Rehabilitation Phase 2 for primary and secondary clarifiers design and construction is programmed in the FY14 CIP at a cost of \$30.0 million during FY14-21. This project is a follow-up to the recently completed phase 1 primary and secondary clarifier rehabilitation project. Additional work needed to correct noted deficiencies includes: influent gate seals, effluent launders, primary sludge removal system, secondary aeration/recirculation system, and concrete corrosion.
- Ancillary Modifications final design and construction 4 for modifications to the cryogenic facility, plant-wide odor control systems, digester gas, and scrubber improvements are programmed in the FY14 CIP at a cost of \$15.124 million during FY15-21.
- Cryogenics Plant Chillers Replacement Project to replace three failing air chillers that require frequent maintenance in the oxygen generation plant is programmed in the FY14 CIP at a cost of \$1.1 million during FY14-15.
- Cryogenics Plant Equipment Replacement design and construction to replace pumps, valves, motors, sensors, switches, instrumentation, etc. at the Cryogenics Plant is programmed in the FY14 CIP at a cost of \$6.9 million in FY14-17.
- Sodium Hypochlorite Pipe Replacement design, construction and REI to replace about 0.5 mile of PVC piping that transports sodium hypochlorite throughout various areas of the plant is programmed in the FY14 CIP at a cost of \$10.558 million during FY14-17. This project will address issues of pipeline corrosion and leakage problems that currently require frequent attention from maintenance staff.
- Chemical Pipeline Replacement design and construction for planned periodic replacement of various chemical pipelines in the disinfection and odor control facilities due to deterioration from corrosion is programmed in the FY14 CIP at a cost of \$2.757 million during FY16-19.
- Sodium Hypochlorite Tank Rehabilitation (future) to strip and reline the four sodium hypochlorite tanks is programmed in the FY14 CIP at a cost of \$10.0 million in FY18-22.
- Sodium Bisulfite Tank Rehabilitation is programmed in the FY14 CIP at a cost of \$2.543 million in FY15-17.

- Gravity Thickener Rehabilitation Improvements design and construction is programmed in the FY14 CIP at a cost of \$5.786 million during FY14-16. This 3-year project will be multi-phased including the following components: replacing fiberglass covers, installation of catwalks around tanks, effluent channel improvements, and upgrades to the roof of the sludge thickener building for access and operating efficiency improvements.
- Gravity Thickener Center Column Replacement Project is programmed in the FY14 CIP at a cost of \$498,000 during FY14. Complete replacement of the center columns in all four gravity thickener tanks with a higher grade steel is required based on previous experience with failures in FY11.
- Centrifuge Back-drive Replacement project is required due to equipment obsolescence and is programmed in the FY14 CIP at a cost of \$3.868 million during FY14-15.
- Centrifuge Replacement design and construction with target of replacement of 4 of 16 worn centrifuges at 10-year intervals is programmed in the FY14 CIP at a cost of \$20.8 million. This initial project covers the first two phases of centrifuge replacement (each a 5 to 6-year project) with phase 1 in the FY16-21 timeframe and phase 2 in the FY24-28 timeframe.
- Digester Modules 1 & 2 Pipe Replacement design and construction to replace the most critically deteriorated glass lined piping is programmed in the FY14 CIP at a cost of \$542,000 during FY14.
- Digester and Storage Tank Rehabilitation design, ESDC, and construction to upgrade the three digester modules and two gas handling/sludge storage tanks is programmed in the FY14 CIP at a cost of \$24.7 million during FY14-22. This 9-year project represents the second phase of improvements to the sludge digesters and gas handling/sludge storage tanks and will include: sludge piping upgrades, valve replacement, recirculation/mixing system improvements, overflow box upgrades, digester wall steel replacement or repair, digester coating, etc.
- Dystor Tank Membrane Replacements are programmed in the FY14 CIP at a total cost of \$3.0 million to be performed in two phases, each 1-year projects. The first phase has a budget of \$1.2 million in FY17 and the second phase has a budget of \$1.8 million in FY25.
- Digester Gas Flare #4 design and construction is programmed in the FY14 CIP at a cost of \$1.515 million during FY19-21.
- Digester Sludge Pump Replacement construction to transfer sludge to the Pellet Plant is programmed in the FY14 CIP at a cost of \$5.474 million during FY14-16.
- Power System Improvements construction for modifications to Deer Island's electrical system to correct back-up power issues as recommended after an FY04 power outage is programmed in the FY14 CIP at a cost of \$3.0 million during FY14-15. Design packages for the upgrades and several construction phases are complete.

- Thermal Power Plant (TPP) Fuel System Modifications (REI phase) is a project to provide resident engineering and inspection services during construction of certain power system improvements related to the TPP. This project is programmed in the FY14 CIP at a cost of \$800,000 during FY14-16.
- Thermal Power Plant (TPP) Boiler Control Replacement to eliminate obsolete equipment is programmed in the FY14 CIP at a cost of \$ 1.0 million during FY14-15.
- LOCAT Scrubber Replacement design and construction to replace the Thermal Power Plant's high-maintenance digester gas wet scrubber system with a dry scrubber system is programmed in the FY14 CIP at a cost of \$5.17 million during FY18-21. The LOCAT system scrubs hydrogen sulfide and other compounds from the digester gas.
- Combustion Turbine Generator (CTG) Rebuilds in the Thermal Power Plant is programmed in the FY14 CIP at a cost of \$6.0 million during FY17-20.
- DI Electrical Equipment Upgrades Phase 4 REI and construction is programmed in the FY14 CIP at a cost of \$12.062 million during FY14-17. Design packages for the upgrades are complete.
- DI Electrical Equipment Upgrades Phase 5 is programmed in the FY14 CIP at a cost of \$23.162 million during FY18-25.
- Switchgear Replacements design and construction to sequentially replace obsolete electrical switchgear throughout the DITP is programmed in the FY14 CIP at a cost of \$5.797 million during FY16-20. This project has a 5-year duration.
- Switchgear Replacements Phase 2 design and construction to continue upgrades to electrical switchgear throughout the plant is programmed in the FY14 CIP at a cost of \$20.5 million during FY17-21.
- HVAC Equipment Replacement design, ESDC, and construction to replace odor control and air handler equipment (including DITP Laboratory fume hoods) is programmed in the FY14 CIP at a cost of \$20.6 million during FY14-20.
- East/West Odor Control Air Handler Replacement (Future) is programmed in the FY14 CIP at a cost of \$2.0 million during FY25-30.
- PICS Distributed Processing Units (DPU) Replacements to replace the distributed processing unit cabinets and internal components of the PICS system is programmed in the FY14 CIP at a cost of \$8.0 million during FY22-23.

- Process Information Control System (PICS) Replacement Construction to replace obsolete hardware components of the Process Information Control System is programmed in the FY14 CIP at a cost of \$5.49 million in two separate phases (each 2-year projects) scheduled for FY15-16 at \$90,000 and FY22-23 at \$5.4 million.
- Fire Alarm System design, construction and REI to upgrade/replace the fire alarm system at the DI plant is programmed in the FY14 CIP at a cost of \$19.9 million during FY14-19.
- Eastern Seawall Repairs design and construction to repair the eroded concrete seawall at Deer Island is programmed in the FY14 CIP at a cost of \$4.174 million in FY15-19. This project has a 5-year duration and will repair tidal damage and exposed rebar at the base of the Eastern Seawall.
- DI Barge Berth and/or Pier Facilities Rehabilitation/Replacement is programmed in the FY14 CIP at a cost of \$2.265 million during FY14-15 and FY19. This project will provide major rehabilitation of the DI barge berth and pier facilities (including floats, ladders, aluminum gratings, etc.) resulting from normal wear and storm/tidal damage.
- DI Roof Replacement Phase 3 is programmed in the FY14 CIP at a cost of \$1.156 million during FY14. This project will substantially complete roof replacements for major DI buildings which began in FY10 (phase 1) and continued in FY11 (phase 2).
- DI Document Format Conversion project to convert DI construction documents into electronic format and complete the document-reference database is programmed in the FY14 CIP at a cost of \$75,000 in FY14.

Projects Recommended for Consideration in future CIPs: There are forty-seven Deer Island Treatment Plant projects recommended for consideration in future CIPs. The projects are described below and summarized in Table 6-1 (see line numbers 6.51 through 6.97).

- DITP Future As-Needed Technical Design (placeholder) Project is recommended for consideration in future CIPs for continuation of the project at a budget of \$2.0 million annually for FY26-53 and a total cost of \$56.0 million.
- DI Future Equipment Replacement Project to provide a long-term placeholder budget for funding new projects and/or increases to existing projects for DITP equipment replacement is recommended for consideration in future CIPs at an estimated cost of \$2.0 million annually during the FY24-53 timeframe (total cost of \$60.0 million over 30 years).
- Future South System Pump Station variable frequency drives (VFDs) replacement design/construction is recommended for consideration in future CIPs (every 10-15 years) at an estimated cost of \$24 million each cycle with a target schedule of FY26, FY36 and FY46 and a total cost during the Master Plan period of \$72.0 million.

- Future South System Pump Station shaft and/or motor replacements to replace worn shafts and/or obsolete motors is recommended for consideration in future CIPs (every 20-25 years) at an estimated cost of at \$6 million each cycle with a target schedule of FY18 and FY40 and a total cost during the Master Plan period of \$12.0 million. Replacement of all eight pump motors is planned for every other cycle that the VFDs are replaced.
- Future North Main Pump Station design/construction to replace VFDs every 10-15 years is recommended for consideration in future CIPs (every 10-15 years) at an estimated cost of \$22 million each cycle with a target schedule of FY38 and FY48 and a total cost during the Master Plan period of \$44.0 million.
- Future North Main Pump Station Motor Replacements (to be coordinated with VFD replacements) is recommended for consideration in future CIPs (every 20-25 years) at an estimated cost of at \$12 million each cycle with a target schedule of FY38. Replacement of all ten pump motors is planned for every other cycle that the VFDs are replaced.
- North Main Pump Station replacement of the motor control center (MCC) are recommended for consideration in future CIPs at an estimated cost of at \$10 million for each cycle with a target schedule of FY34 and FY52 and a total cost during the Master Plan period of \$20.0 million.
- North Main Pump Station removal of the diesel engines (Enterprise Engines) is recommended for consideration in future CIPs at an estimated cost of \$600,000 with a target schedule of FY19. The schedule for this project may be accelerated.
- Winthrop Terminal Facility design/construction to replace variable frequency drives (VFDs) is recommended for consideration in future CIPs (every 10-15 years) at an estimated cost of \$3 million each cycle with a target schedule of FY25, FY35, and FY45 and a total cost during the Master Plan period of \$9.0 million.
- Future design/construction to replace additional miscellaneous VFDs is recommended for consideration in future CIPs (every 10-15 years) at an estimated cost of \$7 million each cycle with a target schedule of FY28, FY38, and FY48 and a total cost during the Master Plan period of \$21.0 million. Each replacement cycle takes at least five years to complete if replacements are performed by in-house staff, since they are completed in batches and there are several hundred of these VFDs.
- Future Winthrop Terminal Facility shaft and/or motor replacements is recommended for consideration in future CIPs (every 20-25 years) at an estimated cost of at \$3 million each cycle with a target schedule of FY25 and FY45 and a total cost during the Master Plan period of \$6.0 million. Motors will be replaced every other cycle that VFDs are replaced.
- Future Cryogenics Plant Equipment Replacement design and construction is recommended for consideration in future CIPs (every 10-15 years) at an estimated cost of \$2.0 million each cycle with a target schedule of FY25, FY35, and FY45 and a total cost during the Master Plan period of \$6.0 million.

- Future Cryogenics Plant Cooling Tower and Related Equipment Replacement is recommended for consideration in future CIPs (every 20 years) at an estimated cost of \$1.5 million each cycle with a target schedule of FY20 and FY40 and a total cost during the Master Plan period of \$3.0 million.
- Future Secondary Clarifier Rehabilitations are recommended for consideration in future CIPs (every 15-20 years) at an estimated cost of \$25.0 million each cycle with a target schedule of FY30 and FY45 and a total cost during the Master Plan period of \$50.0 million.
- Future Secondary Clarifier Drive Chain replacements are recommended for consideration in future CIPs (every 10-15 years) at an estimated cost of \$2.5 million each cycle with a target schedule of FY26, FY36, and FY46 and a total cost during the Master Plan period of \$7.5 million.
- Future Chemical Pipeline Replacement/Upgrade design and construction for planned periodic replacement of various chemical pipelines in the disinfection and odor control facilities is recommended for consideration in future CIPs (every 20 years) at a cost of \$500,000 for each cycle with a target schedule of FY33 and FY53 and a total cost during the Master Plan period of \$1.0 million.
- Sodium Hypochlorite Tank Rehabilitation to strip and reline the four sodium hypochlorite tanks are recommended for consideration in future CIPs (every 10 years) at an estimated cost of \$10.0 million for each project phase (\$2.5 million per tank) with a target schedule of FY30, FY40, and FY50 and a total cost during the Master Plan period of \$30.0 million.
- Future Sodium Bisulfite Tank Rehabilitation to strip and reline the two bisulfite storage tanks is recommended for consideration in future CIPs (every 15 years) at an estimated cost of \$1.0 million per project phase (\$500,000 per tank) with a target schedule of FY30 and FY45 and a total cost during the Master Plan period of \$2.0 million.
- DI Outfall Modifications Inspection project is recommended for consideration in future CIPs (every 20 years) to inspect and make recommendations for cleaning, upgrades, and/or rehabilitation for the DI outfall tunnel, as well as the DI emergency outfalls at an estimated cost of \$3.0 million beginning in FY20 and FY40 and a total cost during the Master Plan period of \$6.0 million.
- Future Centrifuge Back-drive Replacement project is recommended for future CIPs (every 10 years) at an estimated cost of \$3.0 million for each phase with a target schedule of FY25, FY35, and FY45 and a total cost during the Master Plan period of \$9.0 million.
- Future Centrifuge Replacements are recommended for consideration in future CIPs (4 of 16 centrifuges every 10 years) at an estimated cost of \$8.0 million for each project (\$2.0 million per centrifuge) with a target schedule of FY34 and FY44 and a total cost during the Master Plan period of \$16.0 million.

- Future Digester and Storage Tank Rehabilitation design and construction are recommended for consideration in future CIPs (every 15 years) at an estimated cost of \$15.0 million for each phase with a target schedule of FY30 and FY45 and a total cost during the Master Plan period of \$30.0 million.
- Future Dystor Tank Membrane Replacements are recommended for consideration in future CIPs (every 10 years) at an estimated cost of \$1.0 million for each phase with a target schedule of FY33, FY43, and FY53 and a total cost during the Master Plan period of \$3.0 million.
- Future Digested Sludge Pump Replacements are recommended for consideration in future CIPs (every 20 years) at an estimated cost of \$4.0 million for each phase with a target schedule of FY30 and FY50 and a total cost during the Master Plan period of \$8.0 million.
- DI Cross-Harbor Cable Dredging Construction is recommended for consideration in future CIPs as a contingency at \$20.0 million during the FY15-18 timeframe. As a result of a major navigation channel improvement project being planned by the U.S. Army Corps of Engineers (Army Corps) and Massport, a dispute has arisen in which the Army Corps asserts that the cable was not installed at the appropriate depth in certain locations, as specified in its Army Corp permit, and portions must be relocated to permit the navigation improvement project to proceed. The MWRA has formally disclaimed any liability and responsibility for relocating the cable, nonetheless, the MWRA is including a \$20 million contingency fund in the CIP. It is expected that the Army Corps will proceed with its schedule to have the cable relocated by FY18. NSTAR and the Army Corps are currently in litigation over this issue.
- A Future Transformer Replacements placeholder budget is recommended for consideration in future CIPs (every 5 years) at an estimated cost of \$1.5 million for each cycle with a target schedule of FY19, FY24, FY29, FY34, FY39, FY44, and FY49 and a total cost during the Master Plan period of \$10.5 million.
- Future LOCAT Scrubber Rehabilitation/Replacement Project is recommended for consideration in future CIPs at an estimated cost of \$6.0 million during FY36-37. The LOCAT system scrubs hydrogen sulfide and other compounds from the digester gas.
- Future Combustion Turbine Generator (CTG) Rebuilds in the Thermal Power Plant are recommended for consideration in future CIPs (every 15 years) at an estimated cost of \$3.0 million for each cycle with a target schedule of FY30 and FY45 and a total cost during the Master Plan period of \$6.0 million. Each project has an estimated duration of 2 years.
- Steam Turbine Generator (STG) Replacement, to evaluate and consider installation of more efficient equipment, is recommended for consideration in future CIPs at an estimated cost of \$3.5 million for a 3-year project duration during FY18-20.

- Future Heat Loop Pipe Replacement design and construction to continue upgrades/improvements to heat loop piping are recommended for consideration in future CIPs (every 15-20 years) at an estimated cost of \$2.0 million for each cycle with a target schedule of FY20, FY35, and FY50 and a total cost during the Master Plan period of \$6.0 million.
- Future Hydroturbine Generator (HTG) Rehabilitation is recommended for consideration in future CIPs (every 20-25 years) at a cost of \$2.0 million each cycle with a target schedule of FY25 and FY45 and a total cost during the Master Plan period of \$4.0 million.
- Future Electrical Equipment Upgrades (beyond Phase 5) to replace transformers and bus ducts is recommended for consideration in future CIPs (annually) at an estimated cost of \$700,000 annually with a target schedule from FY21 through FY53 and a total cost during the Master Plan period of \$23.1 million.
- Future Switchgear Replacements design and construction (beyond Phase 2) to upgrade/replace electrical switchgear is recommended for consideration in future CIPs (every 10-15 years) at an estimated cost of \$10 million each cycle with a target schedule of FY30, FY40, and FY50 and a total cost during the Master Plan period of \$30.0 million.
- Future Odor Control Air Handler Replacement is recommended for consideration in future CIPs (every 15 years) at an estimated cost of \$3.0 million for each cycle with a target schedule of FY30 and FY45 and a total cost during the Master Plan period of \$6.0 million.
- Future Process Information Control System (PICS) Distributed Processing Units (DPU) Replacements is recommended for consideration in future CIPs (every 20 years) at an estimated cost of \$4.0 million beginning in FY42.
- Future Process Information Control System (PICS) Replacement construction is recommended for consideration in future CIPs (every 15 years) at an estimated cost of \$2.0 million for each cycle with a target schedule of FY37 and FY52 and a total cost during the Master Plan period of \$4.0 million.
- Future HVAC Upgrades/Replacement including the control system, fan coil, etc. is recommended for consideration in future CIPs (every 15 years) at an estimated cost of \$20.0 million for each cycle with a target schedule of FY30 and FY45 and a total cost during the Master Plan period of \$40.0 million.
- Future Fuel Supply Pump and Pipe Replacement or Rehabilitation design and construction is recommended for consideration in future CIPs (every 20 years) at an estimated cost of \$5.0 million for each cycle with a target schedule of FY42.
- Leak Protection System Upgrades to the leak protection system and chemical/fuel tank containment areas is recommended for consideration in future CIPs (every 15 years) at an estimated cost of \$500,000 for each cycle with a target schedule of FY15, FY30, and FY45 and a total cost during the Master Plan period of \$1.5 million.

- DI Water Storage Tank Cleaning/Rehabilitation and Water Pipeline Rehabilitation are recommended for consideration in future CIPs (every 40 years) at an estimated cost of \$2.0 million for each cycle with a target schedule of FY40.
- DI Cathodic Protection Testing is recommended for consideration in future CIPs (every 10 years) at an estimated cost of \$250,000 for each cycle with a target schedule of FY15, FY25, FY35, and FY45 and a total cost during the Master Plan period of \$1.0 million.
- Future Sanitary and Stormwater System Rehabilitation including replacement of ejector pumps and rehabilitation of force mains and gravity pipelines is recommended for consideration in future CIPs (every 20-25 years) at an estimated cost of \$1.0 million for each cycle with a target schedule of FY25 and FY45 and a total cost during the Master Plan period of \$2.0 million. This project has an estimated duration of 2-years.
- Future DI Personnel Protection System Upgrade/Replacement is recommended for consideration in future CIPs (every 10-15 years) at an estimated cost of \$1.0 million for each cycle with a target schedule of FY25, FY35, and FY45 and a total cost during the Master Plan period of \$3.0 million. This project has an estimated duration of 1-year.
- Future DI Seawall Refurbishment design and construction to repair seawall erosion and damage is recommended for consideration in future CIPs (every 10-15 years) at an estimated cost of \$2.0 million for each cycle with a target schedule of FY25, FY35, and FY45 and a total cost during the Master Plan period of \$6.0 million. This project has an estimated duration of 1-year.
- Future DI Barge Berth and/or Pier Facilities Rehabilitation is recommended for consideration in future CIPs (every 20-25 years) at an estimated cost of \$2.0 million for each cycle with a target schedule of FY33 and FY53 and a total cost during the Master Plan period of \$4.0 million. This project has an estimated duration of 1-year.
- DI Personnel Dock Rehabilitation Construction to repair the floats, ladders and aluminum grating of the personnel dock is recommended for consideration in future CIPs (every 15-20 years) at an estimated cost of \$2.0 million for each cycle with a target schedule of FY18, FY33, and FY48 and a total cost during the Master Plan period of \$6.0 million. This project has an estimated duration of 1-year.
- DI Future Roof Replacements is recommended for consideration in future CIPs (every 15 years) at an estimated cost of \$6.0 million for each cycle with a target schedule of FY25 and FY40 and a total cost during the Master Plan period of \$12.0 million. This project has an estimated duration of 3-years.

**Table 6-1
Wastewater Master Plan - Deer Island Treatment Plant
Existing and Recommended Projects**

Last revision 8/22/13

FY14 CIP Notes

new project, not previously in CIP

Project Types
 NF New Facility/System
 RF/IC Replacement Facility/Increase Capacity
 Opti Optimization
 AP Asset Protection
 Plan Planning/Study

Prioritization
 1 Critical
 2 Essential
 3 Necessary
 4 Important
 5 Desirable

Line No	Priority	Project	Project Type	FY14 CIP Project No.	FY14 CIP Contract No.	Project Duration	Cost (\$1000)	Schedule	FY14 CIP Notes				Total Cost (\$1000)
									FY14-18	FY19-23	FY24-33	FY34-53	
DEER ISLAND TREATMENT PLANT													
6.01	2	DI As-Needed Design 7-1, 7-2 and 7-3	AP	206	19353_7399 19354_7400 19566_7434	3 years	3,923	ongoing-FY16	3,923				3,923
6.02	1	DI As-Needed Technical Design (Placeholder) \$2M annually for FY16-26	AP	206	19311_7121	11 years	21,050	FY16-26	5,000	10,000	6,050		21,050
6.03	2	DI Equipment Replacement Projection (Placeholder)	AP	206	19182_6478	5 years	25,000	FY19-23		25,000			25,000
6.04	1	DI Future SSPS VFD Replacement - Design and Construction	AP	206	19316_7126 19317_7127	4 years	24,000	FY18-21	1,800	22,200			24,000
6.05	2	DI SSPS Pump Lube System Replacement	AP	206	19335_7169	3 years	2,900	FY19-21		2,900			2,900
6.06	1	DI NMPS VFD Replacements - REI and Construction	AP	206	19272_6903 19300_7062	3 years	18,212	ongoing-FY16	18,212				18,212
6.07	1	DI Future NMPS VFD Replacements - Design and Construction	AP	206	19318_7128 19319_7129	4 years	22,100	FY22-25		7,183	14,917		22,100
6.08	2	DI NMPS Harmonic Filter Replacement	AP	206	19557_7414	3 years	3,000	FY19-21		3,000			3,000
6.09	1	DI NMPS Motor Control Center (MCC) - Phase 2 Construction	AP	206	19581_7420	3 years	6,086	FY15-17					6,086
6.10	2	DI NMPS Butterfly Valve and Winthrop Terminal Facility Plug Valve Replacement	AP	206	19339_7275	3 years	10,000	FY14-16					10,000
6.11	1	DI Winthrop Terminal Facility and Miscellaneous VFD Replacements - Construction	AP	206	19258_6875 19260_6877	4 years	4,796	ongoing-FY17	4,796				4,796
6.12	1	DI Future Misc. VFD Replacements - Design and Construction	AP	206	19320_7130 19321_7131	7 years	6,667	FY15-21	2,333	4,334			6,667
6.13	1	DI Expansion Joint Repairs - Construction 2 & 3 for Clarifiers and Retaining Walls	AP	206	19217_6704 19218_6705	5 years	2,699	ongoing-FY18	2,699				2,699
6.14	2	DI Clarifier W3H Flush System	AP	206	19346_7374	1 year	71	ongoing-FY14	71				71
6.15	2	DI Clarifier Scum Skimmer (Tip Tube) Replacement	AP	206	19349_7396	4 years	20,000	FY14-17	20,000				20,000
6.16	2	DI Clarifier Rehab Phase 2 (Primary and Secondary) - Design and Construction	AP	206	19347_7394 19348_7395	8 years	30,000	FY14-21	3,417	26,583			30,000
6.17	2	DI Ancillary Modifications - Final Design and Construction #4 for Cryogenics and Other Control	AP	206	19303_7088 19188_6538	8 years	15,124	FY15-21	4,944	10,180			15,124

**Table 6-1
Wastewater Master Plan - Deer Island Treatment Plant
Existing and Recommended Projects**

Last revision 8/22/13

Prioritization
 1 Critical
 2 Essential
 3 Necessary
 4 Important
 5 Desirable

Project Types
 NF New Facility/System
 RF/IC Replacement Facility/Increase Capacity
 Opti Optimization
 AP Asset Protection
 Plan Planning/Study

FY14 CIP Notes
 new project, not previously in CIP

Line No	Priority	Project	Project Type	FY14 CIP Project No.	FY14 CIP Contract No.	Project Duration	Cost (\$1000)	Schedule	FY14 CIP Notes				Total Cost (\$1000)
									FY14-18	FY19-23	FY24-33	FY34-53	
6.18	2	DI Cryogenics Chillers Replacement	AP	206	19352_7398	2 years	1,100	FY14-15	1,100				1,100
6.19	1	DI Cryogenics Plant Equipment Replacement Design and Construction	AP	206	19329_7139 19330_7140	4 years	6,900	FY14-17	6,900				6,900
6.20	2	DI Sodium Hypochlorite Pipe Replacement - Design, Construction and REI	AP	206	19254_6653 19255_6654 19256_7413	4 years	10,558	FY14-17	10,558				10,558
6.21	2	DI Chemical Pipe Replacement - Design and Construction	AP	206	19252_6651 19253_6652	4 years	2,757	FY16-19	2,446	311			2,757
6.22	1	DI Future Sodium Hypochlorite Tank Rehab	AP	206	19332_7142	5 years	10,000	FY18-22	1,667	8,333			10,000
6.23	2	DI Sodium Bisulfite Tanks Rehabilitation	AP	206	40256_7449	3 years	2,543	FY15-17	2,543				2,543
6.24	1	DI Gravity Thickener Rehabilitation	AP	206	19565_7428	3 years	5,786	FY14-16	5,786				5,786
6.25	2	DI Gravity Thickener Center Column Replacement	AP	206	19564_7427	1 year	498	ongoing-FY14	498				498
6.26	1	DI Centrifuge Back-Drive Replacements	AP	206	19295_7057	2 years	3,868	ongoing-FY15	3,868				3,868
6.27	1	DI Centrifuge Replacements - Design and Construction	AP	206	19327_7137 19328_7138	6 years	20,800	FY16-21, FY24-28	520	4,680	15,600		20,800
6.28	1	DI Digester Modules 1 & 2 - Pipe Replacement	AP	206	19283_7055	1 years	542	ongoing-FY14	542				542
6.29	1	DI Digester and Storage Tank Rehab - Design, ESDC and Construction	AP	206	19280_7052 19345_7373	9 years	24,700	FY14-22	1,875	22,825			24,700
6.30	1	DI Dystor Tank Membrane Replacements	AP	206	19325_7135	1 year	3,000	FY17, FY25	1,200	1,800			3,000
6.31	2	DI Digester Gas Flare # 4 - Design and Construction	AP	206	19227_6728 19228_6729	3 years	1,515	FY19-21		1,515			1,515
6.32	2	DI Digester Sludge Pump Replacement - Phase 1 and Phase 2 Construction	AP	206	19313_7123 19246_6621	3 years	5,474	FY14-16	5,474				5,474
6.33	1	DI Power System Improvement - Construction	AP	206	19299_7061	2 years	3,000	ongoing-FY15	3,000				3,000
6.34	2	DI Thermal Power Plant (TPP) Fuel System Modifications - REI	AP	206	19307_7094	3 years	800	FY14-16	800				800
6.35	2	DI Thermal Power Plant (TPP) Boiler Control Replacement	AP	206	19355_7401	2 years	1,000	FY14-15	1,000				1,000
6.36	2	DI LOCAT Scrubber Replacement - Design and Construction	AP	206	19283_6680 19294_7056	4 years	5,170	FY18-21	338	4,832			5,170

**Table 6-1
Wastewater Master Plan - Deer Island Treatment Plant
Existing and Recommended Projects**

Last revision 8/22/13

FY14 CIP Notes
new project, not previously in CIP

Project Types
NF New Facility/System
RF/IC Replacement Facility/Increase Capacity
Opti Optimization
AP Asset Protection
Plan Planning/Study

Prioritization
1 Critical
2 Essential
3 Necessary
4 Important
5 Desirable

Line No	Priority	Project	Project Type	FY14 CIP Project No.	FY14 CIP Contract No.	Project Duration	Cost (\$1000)	Schedule	FY14 CIP Notes			Total Cost (\$1000)	
									5 years	10 years	20 years		
6.37	1	DI CTG Rebuilds	AP	206	19326_7136	4 years	6,000	FY17-20	3,333	2,667		6,000	
6.38	1	DI Electrical Equipment Upgrades Phase 4 - REI and Construction	AP	206	19559_7416 19270_6901	4 years	12,062	FY14-17	12,062			12,062	
6.39	1	DI Electrical Equipment Upgrades Phase 5	AP	206	19314_7124	8 years	23,162	FY18-25	799	15,974	6,389	23,162	
6.40	1	DI Switchgear Replacements - Design and Construction	AP	206	19296_7058 19297_7059	5 years	5,797	FY16-20	2,651	3,146		5,797	
6.41	1	DI Switchgear Replacements Phase 2 - Design and Construction	AP	206	19322_7132 19323_7133	5 years	20,500	FY17-21	2,250	18,250		20,500	
6.42	2	DI HVAC Equipment Replacement - Design, ESOC, and Construction (including DJTP Lab)	AP	206	19309_7111 19310_7110	7 years	20,600	FY14-20	13,793	6,807		20,600	
6.43	2	DI East/West Odor Control Air Handler Replacement - Future	AP	206	19338_7170	6 years	2,000	FY25-30		2,000		2,000	
6.44	2	DI PICS Distributed Processing Units (DPU) Replacement	AP	206	19338_7172	2 years	8,000	FY22-23		8,000		8,000	
6.45	1	DI PICS Replacement - Construction	AP	206	19267_6984 19324_7034	2 years	5,490	FY15-16, FY22-23	90	5,400		5,490	
6.46	2	DI Fire Alarm System Replacement - Design, Construction and REI	AP	206	19273_6904 19289_7051 19563_7428	6 years	19,900	FY14-19	16,758	3,142		19,900	
6.47	4	DI Eastern Seawall Repairs Design and Construction	AP	206	19222_6723 19223_6724	5 years	4,174	FY15-19	1,272	2,902		4,174	
6.48	2	DI Barge Berth and/or Pier Facilities - Rehab/Replacement	AP	206	19334_7168	2 years	2,265	FY14-15, FY19	750	1,515		2,265	
6.49	2	DI Roof Replacement Phase 3	AP	206	19562_7424	1 year	1,156	ongoing-FY14	1,156			1,156	
6.50	3	DI Document Format Conversion	AP	206	19241_6791	1 year	75	ongoing-FY14	75			75	
SUBTOTAL - Existing Projects - Deer Island							456,820		188,385	221,679	46,756	0	456,820

**Table 6-1
Wastewater Master Plan - Deer Island Treatment Plant
Existing and Recommended Projects**

Last revision 8/22/13

Line No	Priority	Project	Project Type	FY14 CIP Project No.	FY14 CIP Contract No.	Project Duration	Cost (\$1000)	Schedule	FY14 CIP Notes					Total Cost (\$1000)
									5 years	5 years	10 years	20 years	new project, not previously in CIP	
Recommended Projects - Deer Island														
6.51	1	DI Future As-Needed Technical Design (Placeholder, \$2M annually)	AP	new		Annual	56,000	FY26-53				16,000	40,000	56,000
6.52	2	DI Future Equipment Replacement Project (Placeholder, \$2M annually)	AP	new		Annual	60,000	FY24-53				20,000	40,000	60,000
6.53	1	DI Future SSPS VFD Replacements (\$24M each recurring every 10 years)	AP	new		5 years	72,000	FY26, 36, 46				24,000	48,000	72,000
6.54	3	DI Future SSPS shaft and/or Motor Replacements (\$8M each recurring every 20-25 years)	AP	new		2 years	12,000	FY18, 40		3,000			6,000	12,000
6.55	1	DI Future NMPS VFD Replacements (\$22M each recurring every 10 years)	AP	new		5 years	44,000	FY38, 48					44,000	44,000
6.56	1	DI Future NMPS Motor Replacements (\$12M each recurring every 20-25 years)	AP	new		2 years	12,000	FY38					12,000	12,000
6.57	1	DI NMPS Motor Control Center - Design & Construction (\$10M each recurring every 18-20 years)	AP	new		2 years	20,000	FY34, 52					20,000	20,000
6.58	5	DI Enterprise Engine Renewal	AP	new		1 year	600	FY19		600				600
6.59	1	DI Future WTF VFD Replacements (\$3M each recurring every 10 years)	AP	new		3 years	9,000	FY25, 35, 45				3,000	6,000	9,000
6.60	1	DI Future Misc. VFD Replacements (\$7M each recurring every 10 years)	AP	new		5 years	21,000	FY28, 38, 48				7,000	14,000	21,000
6.61	3	DI Future WTF shaft and/or Motor Replacements (\$3M each recurring every 20 years)	AP	new		2 years	6,000	FY25, 45				3,000	3,000	6,000
6.62	1	DI Future Cyogenics Plant Equipment Replacement - Design and Construction (\$2M each recurring every 10 years)	AP	new		2 years	6,000	FY25, 35, 45				2,000	4,000	6,000
6.63	2	DI Future Cyogenics Plant Cooling Towers & Related Equipment Replacement (\$1.5M each recurring every 20 years)	AP	new		1 year	3,000	FY20, 40		1,500			1,500	3,000
6.64	3	DI Future Secondary Clarifier Rehabs (\$25M each recurring every 15 years)	AP	new		4 years	50,000	FY30, 45				25,000	25,000	50,000
6.65	1	DI Future Secondary Clarifier Drive Chain Replacement (\$2.5M each recurring every 10 years)	AP	new		1 year	7,500	FY26, 36, 46				2,500	5,000	7,500

**Table 6-1
Wastewater Master Plan - Deer Island Treatment Plant
Existing and Recommended Projects**

Last revision 8/22/13

Line No	Priority	Project	Project Type	FY14 CIP Project No.	FY14 CIP Contract No.	Project Duration	Cost (\$1000)	Schedule	FY14 CIP Notes				Total Cost (\$1000)
									5 years	5 years	10 years	20 years	
6.66	2	DI Future Chemical Pipeline Replacement/Upgrades (\$500k each recurring every 20 years)	AP	new		1 year	1,000	FY33, 53			500	500	1,000
6.67	1	DI Future Sodium Hypochlorite Tank Rehabs (\$10M each recurring every 10 years)	AP	new		4 years	30,000	FY30, 40, 50			10,000	20,000	30,000
6.68	4	DI Future Sodium Bisulfite Tank Rehabs (\$1M each recurring every 15 years)	AP	new		2 years	2,000	FY30, 45			1,000	1,000	2,000
6.69	4	DI Future Outfall Inspections (\$3M each recurring every 20 years)	AP	new		1 year	6,000	FY20, 40		3,000		3,000	6,000
6.70	1	DI Future Centrifuge Backdrive Replacement (\$3M each recurring every 10 years)	AP	new		3 years	9,000	FY25, 35, 45			3,000	6,000	9,000
6.71	1	DI Future Centrifuge Replacements (\$8M recurring every 10 years)	AP	new		1 year	16,000	FY34, 44				16,000	16,000
6.72	2	DI Future Digester and Sludge Storage Tank Rehabilitation - Design and Construction (\$15M recurring every 15 years)	AP	new		4 years	30,000	FY30, 45			15,000	15,000	30,000
6.73	1	DI Future Dystor Tank Membrane Replacements (\$1M for both tanks recurring every 10 years)	AP	new		1 year	3,000	FY33, 43, 53			1,000	2,000	3,000
6.74	1	DI Digested Sludge Pump Replacements (to Pellet Plant - \$4M each recurring every 20 years)	AP	new		1 year	8,000	FY30, 50			4,000	4,000	8,000
6.75	5	DI Cross-Harbor Cable Dredging Construction	AP	new		1 year	20,000	FY15-18	20,000				20,000
6.76	3	DI Future Transformer Replacements (\$1.5M each recurring every 5 years)	AP	new		5 years	10,500	FY19, 24, 29, 34, 39, 44, 49		1,500	3,000	6,000	10,500
6.77	3	DI Future LOCAT Scrubber Rehab/Replacement	AP	new		2 years	6,000	FY36-37				6,000	6,000
6.78	1	DI Future CTG Rebuilds (\$3M each recurring every 15 years)	AP	new		2 years	6,000	FY30, 45			3,000	3,000	6,000
6.79	3	DI STG Replacement	AP	new		3 years	3,500	FY18-20	1,500	2,000			3,500
6.80	1	DI Future Heat Loop Pipe Replacement Design & Construction (\$2M each recurring every 15 years)	AP	new		1 year	6,000	FY20, 35, 50		2,000		4,000	6,000
6.81	3	DI Future HTC Rehabilitation (\$2M each recurring every 20 years)	AP	new		1 year	4,000	FY25, 45			2,000	2,000	4,000

Project Types
 NF New Facility/System
 RF/IC Replacement Facility/Increase Capacity
 Opti Optimization
 AP Asset Protection
 Plan Planning/Study

Priority
 1 Critical
 2 Essential
 3 Necessary
 4 Important
 5 Desirable

FY14 CIP Notes
 new project, not previously in CIP

**Table 6-1
Wastewater Master Plan - Deer Island Treatment Plant
Existing and Recommended Projects**

Last revision 8/22/13

Line No	Priority	Project	Project Type	FY14 CIP Project No.	FY14 CIP Contract No.	Project Duration	Cost (\$1000)	Schedule	FY14 CIP Notes				Total Cost (\$1000)
									5 years	5 years	10 years	20 years	
6.82	1	DI Future Electrical Equipment Upgrades (beyond Phase 5, \$700k annually)	AP	new		Annual	23,100	FY21-53		2,100	7,000	14,000	23,100
6.83	1	DI Future Switchgear Replacements - Design & Construction (\$10M each recurring every 10 years)	AP	new		4 years	30,000	FY30, 40, 50			10,000	20,000	30,000
6.84	3	DI Future Odor Control Air Handler Replacements (\$3M each recurring every 15 years)	AP	new		2 years	6,000	FY30, 45			3,000	3,000	6,000
6.85	2	DI Future PICS Distributed Processing Units (DPU) Replacements (\$4M each recurring every 20 years)	AP	new		2 years	4,000	FY42				4,000	4,000
6.86	1	DI Future PICS Replacement Construction (\$2M each recurring every 15 years)	AP	new		1 year	4,000	FY 37, 52				4,000	4,000
6.87	2	DI Future HVAC Upgrade/Replacement (\$20M each recurring every 15 years)	AP	new		1 year	40,000	FY30, 45			20,000	20,000	40,000
6.88	3	DI Future Fuel Supply Pump and Pipe Replacement/Rehab Design & Construction	AP	new		1 year	5,000	FY42				5,000	5,000
6.89	2	DI Leak Protection System Upgrade (\$500k each recurring every 15 years)	AP	new		1 year	1,500	FY15, 30, 45	500		500	500	1,500
6.90	3	DI Water Storage Tank Cleaning/Rehab and Water Pipeline Rehab (\$2M recurring every 40 years)	AP	new		2 years	2,000	FY40				2,000	2,000
6.91	4	DI Cathodic Protection Testing (\$250k each recurring every 10 years)	AP	new		1 year	1,000	FY15, 25, 35, 45	250		250	500	1,000
6.92	3	DI Future Sanitary and Stormwater System Rehab (\$1M recurring every 20 years)	AP	new		2 years	2,000	FY25, 45			1,000	1,000	2,000
6.93	3	DI Future Personnel Protection Systems Upgrade/Replacement (\$1M recurring every 10 years)	AP	new		1 year	3,000	FY25, 35, 45			1,000	2,000	3,000
6.94	3	DI Future Seawall Relubrication Design/Construction (\$2M each recurring every 10 years)	AP	new		1 year	6,000	FY25, 35, 45			2,000	4,000	6,000
6.95	2	DI Future Barge Berth and/or Pier Facilities Rehab (\$2M each recurring every 20 years)	AP	new		1 year	4,000	FY33, 53			2,000	2,000	4,000
6.96	5	DI Personnel Dock Rehab Construction (\$2M each recurring every 15 years)	AP	new		1 year	6,000	FY18, 33, 48	2,000		2,000	2,000	6,000
6.97	4	DI Future Roof Replacements (\$8M recurring every 15 years)	AP	new		3 years	12,000	FY25, 40			6,000	6,000	12,000
SUBTOTAL - Recommended - Deer Island							689,700		27,250	15,700	199,750	447,000	689,700
SUBTOTAL - Existing and Recommended - Deer Island							1,146,520		215,635	237,379	246,506	447,000	1,146,520

Chapter 7

RESIDUALS PROCESSING AND DISPOSAL (OFF-ISLAND) AT THE PELLET PLANT

7.01 Chapter Summary

Digested sludge is pumped from Deer Island Treatment Plant (DITP) sludge and gas storage tanks through one of two 14-inch, seven mile long force mains that run from DITP to the Residuals Pellet Plant in Quincy. The 14-inch pipelines are embedded in concrete along one side of the 11-foot diameter Inter-Island Tunnel. The force mains connect into a vault at Nut Island and continue through Braintree-Weymouth Tunnel to the Residual Pellet Plant. At the Pellet Plant, digested wastewater sludge from DITP is converted into pellets and distributed for beneficial reuse. Once processed, wastewater sludge is known as residuals or biosolids. The commonly used name for the off-island residuals facility is Residuals Pellet Plant, which will be used in the Wastewater System Master Plan. MWRA's official name for the residuals facility is the Biosolids Processing Facility (BPF).

The Pellet Plant is operated and maintained under a long-term contract (March 2001 through December 2015) with a private firm, the New England Fertilizer Company (NEFCo). The annual operating cost is a function of residuals production and various contractual inflationary indices and has been in the range of \$14 to \$16 million per year. Since NEFCo is responsible for all operation, maintenance, and capital improvements for the term of the contract, MWRA has not incurred any additional major expenditures at this facility. Planning for CIP expenditures after the December 2015 contract expiration date is detailed in this Chapter. The replacement asset value of the Pellet Plant is \$200 million (3% of wastewater system asset value). See detail on Wastewater Infrastructure Replacement Asset Value in Section 3.07.

MWRA's Pellet Plant was built in 1991 and expanded in 2001 to handle the residuals production from DITP secondary treatment facilities. In 2015, the facility equipment will be an average of 20 years old. In July 2010, a comprehensive Residuals Facility Condition Assessment and Utility Reliability project was completed. This project reviewed the adequacy of existing facility components and processes and generally found the facility to be in good to very good condition. Based on the project finding, NEFCo was directed to pay more attention to equipment obsolescence in the facility's electronics/control systems. The assessment also concluded that the major utility systems lacked redundancy and recommended this deficiency be addressed if MWRA continues pelletizing long-term. In FY13, MWRA initiated an assessment of long-term technology options for residuals processing and disposal beyond 2015. Significant reinvestment is anticipated for residuals processing and disposal during the 40-year Wastewater System Master Plan timeframe. Staff have identified a series of potential residuals projects which may be refined based on future assessments.

For the Residuals Pellet Plant, operability of mechanical equipment and maintenance of gas/electric/standby power systems are key elements to minimize risk of component failure. Key decision making to minimize risks includes the cost/benefit of when to replace aging equipment and which/how many spare parts to pre-purchase. The residuals pelletizing process is energy

intensive and, as such, future uncertainties (long-term energy costs, supply reliability, etc.) need to be considered as part of long-range planning.

For residuals processing and disposal (off-island) at the Pellet Plant, \$185.778 million in projects is identified in the 40-year master plan timeframe (FY14-53). Seven projects (\$103.458 million) are programmed in the FY14 CIP. Five additional projects (\$82.32 million) are recommended for consideration in future CIPs. Section 7.07 – Summary of Existing and Recommended Capital Projects includes a consolidated list of all projects recommended in this Chapter.

Near-term (FY14-18):

- \$1.299 million is programmed in the FY14 CIP:
 - \$208,000 for condition assessment/technology and regulatory review project;
 - \$250,000 for co-digestion pilot project;
 - \$788,000 to begin residuals facilities plan and EIR; and,
 - \$303,000 to begin residuals facilities upgrade phase 1 design and engineering services during construction (ESDC).

- \$1.32 million in needs is recommended for consideration in future CIPs:
 - \$620,000 for future Pellet Plant electrical system improvements construction; and,
 - \$700,000 for future Pellet Plant pier rehabilitation construction.

Mid-term (FY19-23):

- \$98.237 million is programmed in the FY14 CIP:
 - \$212,000 to complete residuals facilities plan and EIR;
 - \$1.697 million to complete residuals facilities upgrade phase 1 design and engineering services during construction (ESDC);
 - \$10.0 million for residuals facilities upgrade phase 1 construction;
 - \$14.453 million to begin residuals facilities upgrade phase 2 design and engineering services during construction (ESDC); and,
 - \$71.875 million to begin residuals facilities upgrade phase 2 construction.

Long-term (FY24-33 and FY34-53):

- \$3.672 million is programmed in the FY14 CIP:
 - \$547,000 to complete residuals facilities upgrade phase 2 design and engineering services during construction (ESDC); and,
 - \$3.125 million to complete residuals facilities upgrade phase 2 construction.

- \$81.0 million in needs is recommended for consideration in future CIPs:
 - \$2.0 million for future Pellet Plant technology assessment and/or facilities update project;
 - \$75.0 million for future equipment replacement design and construction; and,
 - \$4.0 million for future building envelope rehabilitation construction.

7.02 Residuals Pellet Plant Overview

Due to space limitations and access issues at Deer Island, the Fore River Shipyard in Quincy was selected as the location for additional MWRA facilities and to support construction of the DITP. The property was acquired by MWRA, renamed the Fore River Staging Area (FRSA), and served as the gateway for staging and marine transport of construction materials and equipment during DITP construction from 1987 to 1992. Phase 1 of the Residuals



Pellet Plant was constructed at the FRSA site in 1991 and the phase 2 expansion was completed in 2001. In December 1991, MWRA began the transport of residuals to the Pellet Plant using specially designed barges. In 2005, the barging operation was ceased and instead MWRA began pumping digested residuals from DITP to the Pellet Plant via two 14-inch force mains (one redundant) located within the Inter-Island and Braintree-Weymouth Tunnels.

The Residuals Pellet Plant is designed to handle up to 180 dry tons per day of residuals with four of the six operational trains running. Current, the plant processes 100 to 110 dry tons per day annual average. The larger design capacity and additional operating trains provide for equipment redundancy within the facility. The degree of available redundancy is directly related to the amount of equipment off-line for repair or maintenance. Residual pellets are shipped by rail or truck for beneficial reuse; however, the pellet market is seasonal so there are large variances in quantities leaving the site.

The Residuals Management Program is part of Wastewater Treatment within the Operations Division. The Director of Wastewater Treatment reports to one of the Deputy Chief Operating Officer under the overall direction of the Chief Operating Officer. The Residuals Department is headed by a Manager on Deer Island, who in turn has an on-site Operations Manager reporting from the Pellet Plant in Quincy.

Permitting of the beneficial reuse and disposal of wastewater residuals is regulated by EPA under 40 CFR part 503 (503s). MassDEP is promulgated to authorize residual reuse and disposal under an Approval of Suitability permitting program. MWRA's Pellet Plant maintains an Approval of Suitability from MassDEP and staff report to EPA pursuant to the 503s. A Conditional Approval also governs the Pellet Plant for Air Pollution Control. In addition, reporting to EPA and MassDEP is also required under MWRA's DITP NPDES permit.

7.03 Pellet Plant Contract Operations, Maintenance, and Ongoing Upgrades

The Pellet Plant is operated and maintained under a contract with NEFCo through December 2015. NEFCo employs approximately 30 staff at the facility and uses a computerized maintenance management system with features similar to MWRA's MAXIMO work order software system. Facility work orders are regularly scheduled and reported on within the maintenance management system. MWRA staff have direct access to all maintenance records. NEFCo reports all maintenance activities to MWRA monthly along with a list of anticipated major repairs. In addition, NEFCo produces a quarterly executive summary maintenance report for MWRA and MassDEP review.

NEFCo is also responsible for capital improvements that are needed to maintain the facility operation through the contract term. The original contract outlined a tentative annual project list; however, projects are revisited regularly based on equipment performance and overall facility needs. NEFCo performs most maintenance with their own forces, but does contract out specialized service on systems such as electrical, elevator, fire alarm, and centrifuge/dryer rebuilds. Record plans and operating manuals are kept at the facility. Recently completed or ongoing upgrades:

- Replacement of facility roof;
- Replacement of dryer drum No. 2;
- Major overhaul of 8 centrifuges;
- Replacement of all 12 polymer pumps;
- Replacement of 2 RTO PLCs;
- Replacement of 2 centrifuge back drive motors and the control panel;
- Installation of two new polymer systems;
- Major overhaul of all 6 residuals dryer trains;
- Replacement of media and refractory repairs in 4 RTOs; and,
- Installation of a new fire protection system.

7.04 MWRA Planning For Residuals Management

The Pellet Plant Condition Assessment and System Reliability Study completed in July 2010 (\$450,000) utilized an independent consultant to assess all major facility equipment components and all support systems, including: power, water, sanitary, and drainage. The next step in facilities planning was to assess what other technology options exist for residuals management and processing, review options that other peer utilities have pursued, and review regulatory trends that may impact decision-making. This Technology and Regulatory Review project is scheduled to be completed in FY14. There will also be separate projects to assess the feasibility of co-digestion at DITP (\$250,000 during FY14-16), as well as Facilities Planning and EIR (\$1.0 million during FY14-20). The planning phase will be followed by two phases of upgrade design, engineering services during construction (ESDC), and construction. Phase 1 and phase 2 design/construction are scheduled during FY18-24 with the combined cost budgeted at \$102.0 million. To estimate long-term capital costs for residuals management, MWRA is assuming that major residuals equipment will be replaced in approximate 15 year cycles during the 40 year master plan period. A place-holder project for future residuals equipment replacement is recommended for consideration in future CIPs and is estimated to be needed during the FY40 timeframe at a total construction cost budget of \$75.0 million.

7.05 Details on Residuals Pellet Plant Operations

The main processes at the Residuals Pellet Plant include: (1) receiving pumped residuals from DITP and storage, (2) residuals dewatering using high-speed centrifuges, (3) pelletization and drying, (4) pellet size classification, (5) dust control and air emission scrubbing, (6) pellet storage, (7) shipping/distribution of final pellet product, and (8) Pellet Plant utilities. Details on each process are described below.

Residuals Pumping and Storage: Until the Braintree-Weymouth Tunnel was completed in April 2005, digested residuals from DITP were barged to the Pellet Plant for processing. Since April 2005, MWRA has been pumping digested residuals from DITP to the Pellet Plant via two 14-inch force mains (one redundant) located within the Inter-Island and Braintree-Weymouth Tunnels. While the residuals pumping process has been very reliable, staff are currently piloting an alternative pump type to improve efficiency. During normal operation, three interconnected one million gallon tanks receive incoming liquid residuals from DITP via the pipelines. There is a fourth one million gallon tank available for backup residuals storage. Centrate (generated from the dewatering process) is pumped back to the MWRA Intermediate Pump Station (IPS) in Weymouth, where it enters the MWRA wastewater collection system (see detail in Chapter 10).



Residuals Dewatering Using Centrifuges:

The purpose of each centrifuge is to concentrate the liquid residuals that enter the centrifuge at approximately 2 percent solids content to a wet cake that leaves the centrifuge at approximately 28 percent solids content. Centrifuges concentrate solids on the basis of density, similar to gravity separation of solids in a clarifier with the exception that centrifugal acceleration applies a separation force on the suspended particles up to thousands of times the acceleration of gravity. This increased acceleration results in higher concentration of solids than belt filter presses can achieve. There are a total of twelve centrifuges, two for each pelletizing train. The centrifuges are paired up to discharge into one of six wet cake bins. Each dewatering centrifuge consists of a high speed, rotating cylinder that receives residuals through an injection tube. Centrifugal force pushes solids towards the discharge port resulting in separation of solids from the liquid centrate. Polymer is added to aid the dewatering process.



Pelletization and Drying: The facility houses six similar pelletizing trains. Dewatered residuals are deposited in the wet cake storage bins and conveyed to mixing screws where it is combined with a dry (96 percent solids) recycled material (small pellets). The recycled material is coated with wet cake while being mixed and conveyed by a set of mixer screws, forming larger, partially wet pellets. The wet pellets are delivered to a pug mill mixer (one for each dryer train). The pug mills perform final mixing and help shape the pellets prior to feeding them to the dryer via the dryer feed conveyor. The interaction of the hot gasses, the mixed material, and the rotary action of the dryer drum produces the final product density (41 lbs per cubic foot) and moisture content (96 percent solids). A natural gas burner produces hot air to dry the pellets in a rotary drum dryer. The burner system is a semi-automatic system featuring throttling fuel valves, safety shut-off solenoid valves, manual shut-off valves, pressure gauges, and a throttling air valve.

Pellet Size Classification: The air stream and dried pellets enter the Baker-Rullman separator tangentially, which creates a centrifugal motion. The velocity slows to allow separation of the pellets from the air stream. The pellets drop to the bottom of the separator and are conveyed to the screener. The screener separates the pellets by size. Pellets that are too small fall through the screens to the recycle conveyor. Pellets that are too big are crushed into small pellets and sent to the recycle conveyor. The recycle conveyor transports the small pellets to the recycle bin where they wait to begin the process again. Pellets that are the correct size are cooled in the pellet cooler before being pneumatically transported to the storage silos. The air stream, carrying some fine particulate and moisture, is ducted from the top of the separator to the venturi scrubber and packed tower.

Dust Control and Air Emission Scrubber: The dust system controls fugitive dust generated by the solids handling process equipment. Vent connections at various pieces of equipment are ducted to a dust collector and fan. Each pelletizing train has an individual dust collector and fan. The collected dust is fed, via a rotary airlock, to either the recycle conveyor or diverted to a container for off-site disposal. The venturi scrubbers/packed towers (connected in series) are designed to achieve outlet emissions of 0.009 or less grains per dry standard cubic foot. The first stage venturi scrubber collects particulate, while the second stage packed tower is used mainly for air/water separation (condensing) and ammonia removal.

Pellet Storage: There are five original and four newer pellet storage silos. Each of the five original silos is 32 feet in diameter and 88 feet high, with a capacity of 34,000 cubic feet. The four newer silos are each 32 feet in diameter and 95 feet high, with a capacity of 38,000 cubic feet. The bottom of each silo has an elevated cone to allow railcar access underneath the row of silos. A dust collector is mounted on the silo deck to capture dust in the air exhausted from the silo. Also on the deck of each silo are two 3-inch pneumatic conveying fill connections, nine thermocouple cables, a level transmitter, and

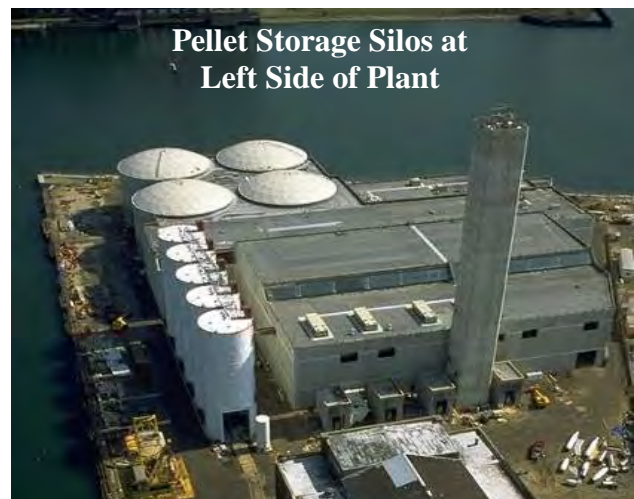

a 24-inch man-way. The silo deck has been designed as an explosion relief deck. In the event of excessive pressure build-up, the bolts holding the deck will shear and allow the deck to move off the silo walls. Restraining cables connect the deck to the silo walls.

Under the skirt of the silo is the PEBCO load-out system and nitrogen purge jets. For each silo, a control panel is located in the silo skirt to operate the load-out system. A panel with the loading scale is provided in Silo 2. The two end silos are provided with electrically operated overhead rollup doors. These doors are opened and closed by a local control. Both sets of silos are equipped with a nitrogen distribution system used to control the temperature of the stored product by displacing oxygen and thereby reducing biological activity.

Shipping/Distribution of Final Pellet Product: Pellets are stored in the silos until ready for distribution to customers. Pellets can leave the facility via truck or rail. The mode of transportation is usually dictated by the location and receiving capabilities of customers, as well as order size. On a peak day approximately eight trucks leave the site; on an average day only three. Railcar trips are fewer due to their larger unit capacity. During the New England growing season, most pellets leave the site by truck for local customers. During other seasons, customers are located in moderate climate regions and distribution is typically via rail. Additional information on rail transport via the Fore River Railroad is provided in Section 7.6.



To support beneficial reuse of residuals, MWRA directly markets the final pellet product locally for wholesale distribution under the name Bay State Fertilizer. The product is bagged by NEFCo under the terms of their contract. MWRA's Bay State Fertilizer pellets are distributed throughout New England and used by golf courses and sod farms. Local garden supply houses also market the product. In addition, Bay State Fertilizer is available free of charge to all MWRA member communities.

Under the terms of NEFCo's contract with MWRA, NEFCo is required to provide emergency backup landfill capability for residuals cake and/or finished dry pellet disposal. NEFCo maintains an agreement with New England Organics to provide backup space at a number of sites throughout New England and New York. The backup landfill has been used for one 40-day period in late 2008 to support disposal of residuals cake while repairs were made at the pellet facility due to a duct work fire.

Pellet Plant Utilities and Pier: The Pellet Plant is powered through the local electrical supplier and also utilizes natural gas to fire the rotary dryer system. In addition, there is a small degree of emergency generator power on-site that can accommodate basic building needs during a power outage. The emergency generator cannot power the residuals processing operation. With the completion of the IPS, the facility's water is provided through an MWRA connection and sanitary sewage generated at the Pellet Plant is pumped directly to the MWRA collection system at the IPS. A project to upgrade utilities at the Residuals Pellet Plant (including water, sewer, electrical, and telephone) will be evaluated during facilities planning and design. Future projects

to rehabilitate the Pellet Plant building envelope (doors, windows, siding, roof, etc) and make improvements to the plant electrical system are recommended for consideration in future CIPs.

A CIP project to study and develop a recommendation to rehabilitate or demolish the pier adjacent to the Pellet Plant had been previously recommended by staff and included in previous CIPs. The previous project was deleted from the CIP in FY10. The pier is informally monitored to ensure its condition does not impact the structural integrity of the Pellet Plant building. A future project to study the pier and make a recommendation for rehabilitation (design and construction) is recommended for consideration in future CIPs so that the ability to barge to and from the Pellet Plant can be maintained.

7.06 Fore River Railroad

The Fore River Railroad is owned by MWRA and operated under contract by the Fore River Transportation Corporation. The 2.7-mile-long rail line runs from Quincy Point to the Greenbush Commuter Line in Braintree. The railroad ships Bay State Fertilizer from the Residuals Pellet Plant for MWRA and NEFCo, as well as fatty acids for a local manufacturing plant, Twin Rivers Technologies.

The Fore River Railroad was developed by Thomas A. Watson, assistant to telephone inventor Alexander Graham Bell. Watson used his telephone profits to start an engine and boat factory in East Braintree, The Fore River Shipyard Engine Company. In 1900, the company moved to a new facility at Quincy Point. At first, transporting heavy materials to Watson's new shipyard was a slow and expensive process since the nearest railroad ended over two miles away in East Braintree. In 1902, Watson had a private rail line built along the Fore River to bring supplies directly from East Braintree to the shipyard at Quincy Point. Railroad operations on the new Fore River line began on June 1, 1903. The Bethlehem Steel Corporation purchased the Fore River Shipyard and Railroad just before World War I. In 1919, the Fore River Railroad was formally incorporated as a separate holding from the Bethlehem Steel shipyard. General Dynamics Corp. purchased the shipyard and railroad in 1963.

In 1987, MWRA acquired the Fore River Shipyard and Railroad. From 1987 through 1992, MWRA used the Fore River facilities as a staging area and transportation system for the Boston Harbor Project. The facility was renamed the Fore River Staging Area during this period. MWRA sold most of the shipyard property upon completion of the Boston Harbor Project. MWRA maintains ownership of a 23 acre portion of the former shipyard for the Residuals Pellet Plant operation and the Fore River Railroad to transport its Bay State Fertilizer.

7.07 Summary of Existing and Recommended Capital Projects

All Master Plan projects related to off-island residuals processing and disposal at the Pellet Plant are summarized in this Section. Table 7-1 lists each project, its cost, its priority ranking, and the proposed expenditure schedule. A description and justification for each project is listed in bullet format.

Projects in the FY14 CIP: There are seven Residuals Pellet Plant related projects programmed in the FY14 CIP. The projects are described below and summarized in Table 7-1 (see line numbers 7.01 through 7.07).

- Residuals Facility Condition Assessment/Utility Reliability Study and Technology and Regulatory Review is a two phase project programmed in the FY14 CIP. The first phase, to evaluate the condition of the entire Pellet Plant prior to the end of the NEFCo contract (December 2015), was completed in July 2010. The second phase, technology and regulatory review, is being implemented during FY13-14. The overall budget for the project is \$959,000, with \$751,000 previously expended through FY13 and \$208,000 budgeted in FY14.
- A co-digestion pilot project was added to the CIP for FY14-16 at a budget of \$250,000. This project will evaluate the impacts of adding food waste, oils and grease to the digesters at DITP and determine what changes in sludge characteristics may result that could have an impact on the residual Pellet Plant process. Based on the outcome of the pilot project, additional capital expenditures at DITP and/or at the Pellet Plant may be recommended, but are not identified in the 2013 Wastewater System Master Plan.
- Residuals Facilities Plan and Environmental Impact Report (EIR) will follow-up on the work completed in the Condition Assessment/Technology Review Project. The Facilities Plan will identify selected options for future design/construction of Pellet Plant upgrades. Cost is estimated at \$1.0 million with duration of 7-years during the FY14-20 timeframe and is programmed in the FY14 CIP. The Residuals Pellet Plant was identified as having a “High Risk” (likely affected by a 100 year flood) in the “Report on Severe Weather Preparedness for MWRA Coastal Facilities” as presented in a Staff Summary at the October 16, 2013 Board of Directors meeting (see details in that report). The flood risk for the Pellet Plant Facility and MWRA’s benchmark of the current 100 year flood elevation plus an additional 2.5 feet to account for sea level rise and more severe storms should be evaluated as part of the Facilities Plan project.
- Residuals Facilities Upgrade Phase 1 Design Services and Engineering Services During Construction (ESDC) to implement priority equipment/process replacements and/or upgrades at the Pellet Plant are programmed in the FY14 CIP at an estimated cost of \$2.0 million with duration of 3-years during the FY18-20 timeframe.
- Residuals Facilities Upgrade Phase 1 Construction of priority construction subphases at the Pellet Plant is programmed in the FY14 CIP at an estimated cost of \$10.0 million with duration of 2-years during the FY19-20 timeframe.
- Residuals Facilities Upgrade Phase 2 Design Services and Engineering Services During Construction (ESDC) to implement all remaining equipment/process replacements and/or upgrades at the Pellet Plant are programmed in the FY14 CIP at an estimated cost of \$15.0 million with duration of 6-years during the FY19-24 timeframe.
- Residuals Facilities Upgrade Phase 2 Construction of all remaining construction subphases at the Pellet Plant is programmed in the FY14 CIP at an estimated cost of \$75.0 million with duration of 6-years during the FY19-24 timeframe.

Projects Recommended for Consideration in Future CIPs: There are five Residuals Pellet Plant related projects recommended for consideration in future CIPs. The projects are described below and summarized in Table 7-1 (see line numbers 7.08 through 7.12).

- Future Residuals Pellet Plant Technology Assessment and/or Facilities Update to plan for continued future rehabilitation/upgrade needs is recommended for consideration in future CIPs at a cost of \$1.0 million per cycle (approximately every 15 years) with a long-term projection for FY30 and FY45 and a project duration of 1-year.
- Future Residuals Pellet Plant Equipment Replacements (design and construction) is recommended for consideration in future CIPs at a cost of \$75.0 million. Future equipment upgrades are anticipated to be required at the end of equipment useful life with a long-term projection for FY40 and project duration of 10-years.
- Future Building Envelope Rehabilitation (construction) for periodic rehabilitation of Pellet Plant doors, windows, siding, etc. is anticipated to be needed approximately every 15 years and is recommended for consideration in future CIPs with future projects projected to begin in FY33 (\$2 million budget) and FY48 (\$2 million budget) at a total cost of \$4 million and a project duration of 1-year each.
- Future Residual Pellet Plant Electrical System Improvements are recommended for consideration in future CIPs (planning, design, and construction) at an estimated cost of \$620,000 with a 1-year project duration and a projected schedule for FY18.
- Future Residual Pellet Plant Pier Rehabilitation is recommended for consideration in future CIPs (planning, design, and construction) at an estimated cost of \$700,000 with a 2-year project duration and a projected schedule for FY17-18. This project is recommended for MWRA to maintain the ability to barge to and from the Residuals Pellet Plant.

**Table 7-1
Wastewater Master Plan - Residuals Processing and Disposal at the Pellet Plant (Off-Island)
Recommended Projects**

Last revision 8/6/13

Line No	Priority	Project	Project Type	FY14 CIP Project No.	FY14 CIP Contract No.	Project Duration	Cost (\$1000)	Schedule	FY14 CIP Notes				Total Cost (\$1000)	
									5 years	5 years	10 years	20 years		
RESIDUALS														
7.01	1	Residuals Condition Assessment/Technology and Regulatory Review	Plan	271	26072_7147	1 year	208	ongoing-FY14	208					208
7.02	1	Co-Digestion Pilot	Plan	271	26073_7148	3 years	250	FY14-16	250					250
7.03	1	Residuals Facilities Plan and EIR	Plan	271	26069_7143	7 years	1,000	FY14-20	788	212				1,000
7.04	1	Residuals Facilities Upgrades Phase 1 Design and ESDC	AP	271	26070_7145	3 years	2,000	FY18-20	303	1,697				2,000
7.05	1	Residuals Facilities Upgrades Phase 1 Construction	AP	271	26071_7146	2 years	10,000	FY19-20		10,000				10,000
7.06	1	Residuals Facilities Upgrades Phase 2 Design and ESDC	AP	271	26073_7148	6 years	15,000	FY19-24		14,453	547			15,000
7.07	2	Residuals Facilities Upgrades Phase 2 Construction	AP	271	26075_7150	6 years	75,000	FY19-24		71,875	3,125			75,000
SUBTOTAL - Existing - Residuals							103,458		1,549	98,237	3,672	0	103,458	
7.08	3	Residuals Future Pellet Plant Technology Assessment and/or Facility Update	Plan	new		1 year	2,000	FY30_45			1,000			2,000
7.09	3	Residuals Future Equipment Replacements	AP	new		10 years	75,000	FY40				75,000		75,000
7.10	3	Residuals Future Building Envelope Rehabilitation	AP	new		1 year	4,000	FY33_48			2,000			4,000
7.11	1	Residuals Future Pellet Plant Electrical System Improvements - Design/Construct	AP	new		1 year	620	FY18	620					620
7.12	3	Residuals Future Pellet Plant Pier Rehabilitation	AP	new		2 years	700	FY17-18	700					700
SUBTOTAL - Recommended - Residuals							82,320		1,320	0	3,000	78,000		82,320
SUBTOTAL - Existing and Recommended - Residuals							185,778		2,869	98,237	6,672	78,000		185,778

CHAPTER 8

COLLECTION SYSTEM REMOTE HEADWORKS AND CROSS-HARBOR TUNNELS

8.01 Chapter Summary

MWRA's wastewater collection system is a complex network of conduits and facilities that is strongly influenced by seasonal and wet weather conditions. The system average daily flow is approximately 360 mgd, minimum dry weather flow is approximately 260 mgd, and peak wet weather capacity to the Deer Island Treatment Plant (DITP) is 1,270 mgd with additional system capacity available at combined sewer overflow (CSO) outfalls. The MWRA collection system includes a network of 274 miles of sewer pipelines (19 miles of cross-harbor tunnels, 226 miles of gravity sewers, 18 miles of force mains, 7 miles of siphons, and 4 miles of CSO and emergency outfalls); 13 pump stations; one screening facility; six CSO treatment/storage facilities; and four remote headworks facilities.

In this Chapter, MWRA's four remote headworks facilities (Chelsea Creek, Columbus Park, Ward Street, and Nut Island) and 19 miles of cross-harbor tunnels are detailed. The Intermediate Pump Station and Winthrop Terminal Headworks are also discussed; however, detail on these facilities is presented in Chapter 6 for the Winthrop Terminal Headworks and Chapter 10 for the Intermediate Pump Station.

The remote headworks and cross-harbor tunnels are critical facilities because almost all flow to the DITP passes through them. The primary function of the remote headworks is to remove grit and screen out debris from wastewater flow to minimize solids accumulation in the cross-harbor tunnels and protect the downstream pump facilities at the DITP. The cross-harbor tunnels (North Metropolitan Relief Tunnel, Boston Main Drainage Tunnel, Inter-Island Tunnel, and Braintree-Weymouth Tunnel) transport wastewater from the remote headworks to the DITP. MWRA's goal is to operate and maintain these facilities to provide uninterrupted wastewater collection service in a safe, cost-effective, and environmentally sound manner.

The replacement asset value of the headworks is \$190 million (3% of wastewater system asset value) and the cross-harbor tunnels is \$660 million (10% of wastewater system asset value). See detail on Wastewater Infrastructure Replacement Asset Value in Section 3.07. The facilities are detailed within the Chapter Sections noted below:

- 8.03 Chelsea Creek Headworks
- 8.04 Columbus Park Headworks
- 8.05 Ward Street Headworks
- 8.06 Nut Island Headworks
- 8.07 Intermediate Pump Station
- 8.08 Winthrop Terminal Headworks
- 8.10 Boston Main Drainage Tunnel
- 8.11 North Metropolitan Relief Tunnel
- 8.12 Inter-Island Tunnel
- 8.13 Braintree-Weymouth Tunnel

The Chelsea Creek, Columbus Park, and Ward Street Headworks were all built in 1967 and are 45 years old. Equipment at the headworks was upgraded by MWRA in 1987 and is now 25 years old. These three older facilities remain operational, but, largely due to age and equipment obsolescence, are in only fair condition and need significant reinvestment in the immediate future. The Nut Island Headworks, built in 1998, is relatively new and is in very good condition. Some minor equipment rehabilitation and replacement projects are recommended; however, significant reinvestment is not required in the short-term.

For the headworks, operability of mechanical equipment and maintenance of electric/standby power systems are key elements to minimize risk of facility failure. Malfunction of mechanical equipment may impact sewer service, particularly during large storm events that stress the hydraulic capacity of the facilities, potentially requiring “choking” of the headworks influent gates that can result in upstream CSOs and potential SSOs. Key decision making to minimize risks includes the cost/benefit of when to replace aging equipment and which/how many spare parts to pre-purchase. Other headworks uncertainties include future energy/chemical costs.

A Headworks Condition Assessment/Concept Design project was completed in FY10. This project reviewed the adequacy of existing headworks components and processes and provided replacement/upgrade recommendations based upon current technology, including mechanical screens, grit removal, odor control, and remote operation of the three remote headworks using SCADA. Information developed by this project has been used by MWRA to produce a prioritized list of recommended design/construction projects that is scheduled over a 11-year period (FY12-22). Programmed in the FY14 CIP are two design/construction projects that target upgrades for the three headworks (first Chelsea Creek Headworks during FY14-17, second Ward Street and Columbus Park Headworks will be upgraded together during FY16-22). The total cost of the projects is budgeted at over \$164 million. The implementation of sequential design/construction contracts for the three remote headworks (first Chelsea Creek Headworks and second the combined Ward Street/Columbus Park Headworks project) was revised during the FY14 budget to produce both an efficient and cost effective project schedule.

A group of smaller scale replacement/upgrade projects are planned for the Nut Island Headworks during the short and mid-term. These projects include work on the electrical, grit/screenings, and odor control systems, as well as a study of settlement at the fire pump building.

One of the most important themes of the Master Plan, consistent for all MWRA water and wastewater facilities, is prioritization of rehabilitation and replacement projects to facilitate long-term asset protection. A long-term annual asset protection budget is needed as a place-holder to fund smaller scale projects that, individually, may not be seen as high priority. A long-term annual asset protection project targeting the remote headworks facilities is recommended for consideration in future CIPs at an annual budget of \$1.0 million during the FY24-53 period for a total estimated cost of \$30.0 million over 30 years.

With respect to the cross-harbor tunnels, the North Metropolitan Relief Tunnel and Boston Main Drainage Tunnel were built in 1953 and are 60 years old. The Inter-Island Tunnel (1996) and Braintree-Weymouth Tunnel (2005) are relatively new. The existing condition of the tunnels is unknown; therefore, there is uncertainty associated with the potential for future repair/rehabilitation and risk of a very large future cost. Some deterioration of concrete in the tunnel shafts has been documented and attributed to hydrogen sulfide corrosion. Since the cross-

harbor tunnels and shafts are critical facilities, a study of the effluent shafts, as well as a tunnel inspection and shaft repair project (planning, design and construction) are a high priority. The headworks effluent shaft study is programmed in the FY14 CIP at \$500,000 during FY16-17. The cross-harbor tunnel inspection and shaft repairs project is programmed in the FY14 CIP at \$5.0 million during FY19-21. Based on the industry benchmark of 100+ years for useful life for tunnels, it is assumed that the older tunnels are still in good condition. An additional long-term cross-harbor tunnel inspection, condition assessment, and cleaning/rehabilitation project is recommended for consideration in future CIPs at a placeholder cost of \$50.0 million with a target schedule of FY46-50.

For the remote headworks and cross-harbor tunnels, \$293.317 million in projects are identified in the 40-year master plan timeframe (FY14-53). Ten projects totaling \$182.817 million are programmed in the FY14 CIP. Four additional projects totaling \$110.5 million are recommended for consideration in future CIPs. Section 8.14 – Summary of Existing and Recommended Capital Projects includes a list of all projects recommended in this Chapter.

Near-term (FY14-18):

- \$62.256 million is programmed in the FY14 CIP:
 - \$6.788 million to continue Chelsea Creek Headworks Upgrade design, construction administration, and resident engineering inspection;
 - \$39.275 million to begin Chelsea Creek Headworks Upgrade construction;
 - \$3.825 million to begin Ward Street and Columbus Park Headworks Upgrade design, construction administration, and resident engineering inspection;
 - \$8.518 million for Nut Island Headworks electrical and grit/screenings conveyance design and construction;
 - \$1.75 million to begin Nut Island Headworks mechanical and electrical replacements;
 - \$600,000 for Nut Island Headworks fire pump building study;
 - \$1.0 million for Nut Island Headworks odor control system evaluation and design; and,
 - \$500,000 for an effluent shaft study at all remote headworks.

Mid-term (FY19-23):

- \$120.561 million is programmed in the FY14 CIP:
 - \$284,000 to complete Chelsea Creek Headworks Upgrade design, construction administration, and resident engineering inspection;
 - \$12.775 million to complete Chelsea Creek Headworks Upgrade construction;
 - \$5.922 million to complete Ward Street and Columbus Park Headworks Upgrade design, construction administration, and resident engineering inspection;
 - \$95.330 million for Ward Street and Columbus Park Headworks Upgrade construction;
 - \$1.25 million to complete Nut Island Headworks mechanical and electrical replacements; and,
 - \$5.0 million for the Cross-Harbor Tunnel inspection and shaft repair project.
- \$500,000 in needs is recommended for consideration in future CIPs:
 - \$500,000 for pier rehabilitation at the Nut Island Headworks.

Long-term (FY24-33 and FY34-53):

- \$110.0 million in needs is recommended for consideration in future CIPs:
 - \$30.0 million for long-term wastewater facility asset protection for remote headworks facilities, estimated based on a budget of \$1.0 million per year over 30 years;
 - \$30.0 million for long-term Nut Island Headworks future equipment replacement; and,
 - \$50.0 million as a placeholder cost for long-term cross-harbor tunnel inspection, condition assessment, and cleaning/rehabilitation.

8.02 Facilities Overview

Key information on each headwork facility is provided in Table 8-1. The location of each remote headworks and cross-harbor tunnel is shown on Figure 8-1. The service area tributary to each headwork facility is shown on Figure 8-2.

Table 8-1

MWRA Headworks				
Facility/Location	Average Daily Flow (MGD)	Peak Capacity (MGD)	Year Built	Flow Received From
Chelsea Creek Headworks Chelsea	135	350	1967 upgrade 1987	North Metropolitan Sewer, North Metropolitan Relief Sewer, East Boston & Revere Branch Sewers, Chelsea & Malden Branch Sewers, Malden Relief Sewer, Wakefield Relief & Edgeworth Branch Sewers, and Wakefield Trunk Sewer
Columbus Park Headworks South Boston	40	182	1967 upgrade 1987	Columbus Park Connection, New Boston Main Interceptor, Dorchester Interceptor and South Boston Interceptor
Intermediate Pump Station (IPS) North Weymouth	14.8	45	2005	Braintree-Weymouth Extension Sewer, Randolph Trunk Sewer & Holbrook Extension Sewer
Nut Island Headworks Quincy	125	400	1998	High Level Sewer
Ward Street Headworks Roxbury	90	256	1967 upgrade 1987	Boston Main Drainage Relief Sewer, Charles River Valley Sewer, South Charles Relief Sewer, North Charles Metropolitan Sewer, & North Charles Relief Sewer
Winthrop Terminal Headworks Deer Island, Boston	14	125	1970	North Metropolitan Trunk Sewer

FIGURE 8-1 Headworks & Harbor Tunnel Location Plan



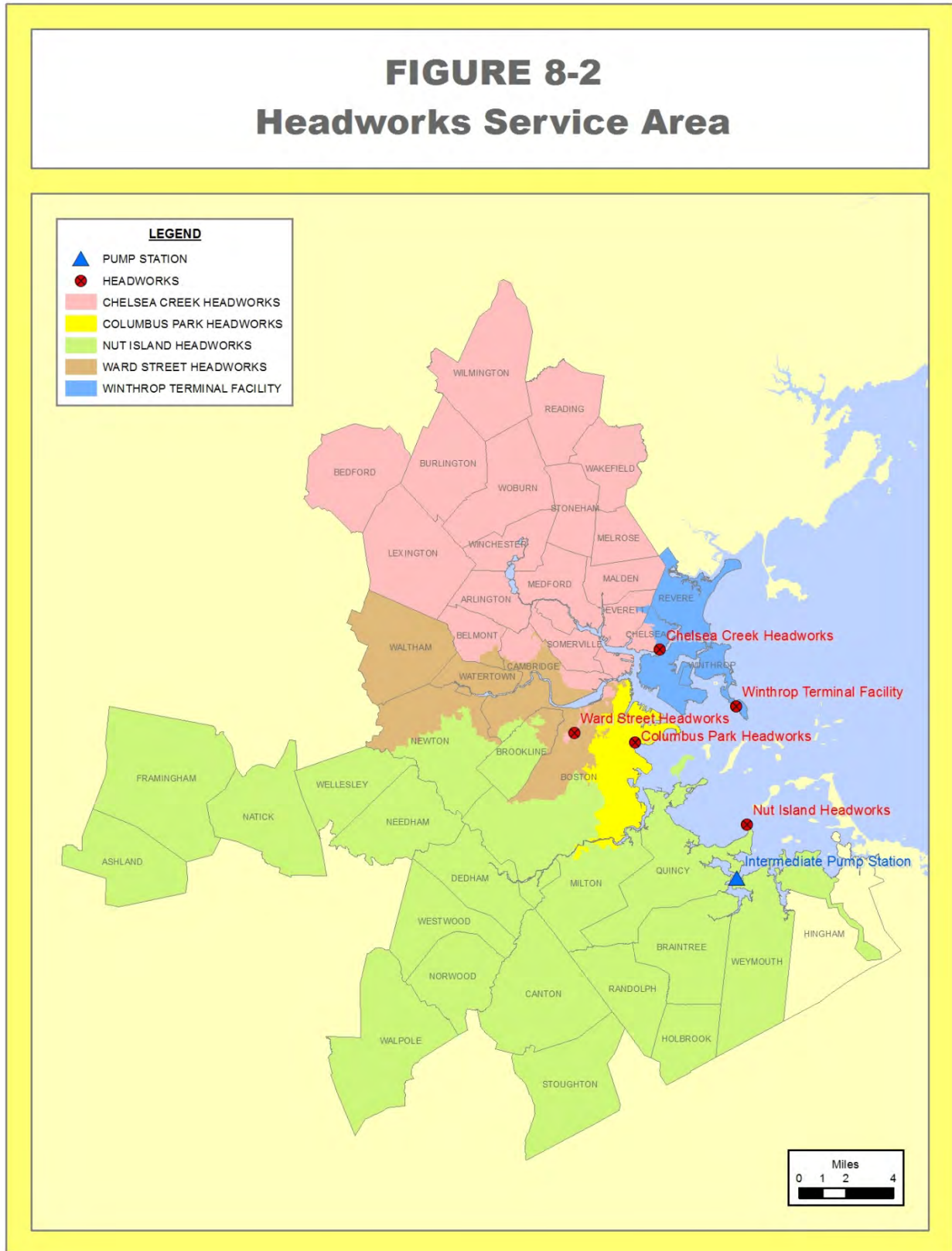

Management of the remote headworks facilities is the responsibility of the Wastewater Operations and Maintenance Department, which is a subset of the Operations Division under the oversight of the Chief Operating Officer and one of the Deputy Chief Operating Officers. Key supervisory staff reporting to the Director, Wastewater Operations and Maintenance Department include: Manager, Operations and Manager, Maintenance.

Operation and Maintenance: Each remote headworks has dedicated staff that operate the facility 24-hours per day. A total of about 20 employees are assigned to the facilities; in addition, roving crews supplement dedicated staff for operation and maintenance. All four remote headworks have very similar operations and have current standard operating procedures (SOPs) that contain specific information on facility operation and maintenance procedures. In addition, operation and maintenance manuals, generally furnished by the manufacturer, are available for major equipment (bar screens, grit removal, generators, etc.). Operations data are scanned via mini-computer at the headworks and downloaded to a central computer. All system scans that produce abnormal readings are checked by area supervisors and the headworks manager. Facility Maintenance and Equipment Maintenance are two consolidated programs made up of the mechanic specialists, machinists, metalworkers, welders, plumbers, HVAC specialists, electricians, building & grounds workers, and facility specialists (carpenters and painters). These groups (a total of about 89 staff) perform maintenance activities at both wastewater and water facilities. Work Coordination in the Operations and Maintenance Department provides scheduling and job planning at all wastewater facilities. All maintenance is scheduled through the MAXIMO system (see detail below).

Facility Operation: Influent gates at headworks facilities are used to control flow to the facility. Mechanical bar screens remove large debris. Screenings are transferred to a screenings dumpster for disposal at an off-site landfill. Grit is removed for disposal off-site. Wastewater flow is metered at each remote headworks and all have odor control systems. Electric service is provided to each facility via local commercial service and all have backup generators for emergency power.

Facility Maintenance: A primary focus of operation and maintenance staff in the Field Operations Department is preventive maintenance. Tasks performed by operational staff as generally defined as light maintenance duties that increase the number of maintenance staff work hours dedicated to maintenance activities. Dedicated staff at the headworks use a handheld monitoring device to perform daily checks of equipment. This information is captured in MWRA's MAXIMO work order system. The MAXIMO computerized maintenance management system records all work activities and work order requests from operations and maintenance personnel. This system gives management the ability to track maintenance needs, prioritize work orders, and generate reports of open and closed work activities. Reports can be generated and information retrieved about the condition of any equipment. Abnormal conditions are noted and forwarded to planner/schedulers for work order processing and further action by the Equipment Maintenance Section. Backlog levels depend on available resources, but daily coordination ensures that primary and critical equipment is functioning at adequate levels at all times. Work is prioritized, with critical equipment receiving the most attention.

MWRA In-House Tasks: There are two in-house tasks related to the headworks facilities recommended to be completed by MWRA staff:

- Staff should review/update SOPs for all headworks facilities; and,
- Staff should update the 2002 Equipment and Operational Summary for Wastewater Transport Facilities.

Service Contracts: The in-house maintenance program is supplemented by a series of service contracts, as listed below:

- Architectural, electrical, HVAC, and mechanical engineering design;
- Boiler and water heater service maintenance;
- Compressed air maintenance;
- Crane maintenance;
- Diesel generator maintenance;
- Elevator maintenance;
- High voltage maintenance;
- HVAC pneumatic controls maintenance;
- Hydraulics maintenance;
- Instrumentation maintenance;
- Nut Island landscape maintenance;
- Overhead door maintenance; and,
- Pump variable frequency drive maintenance.

Headworks Condition Assessment/Concept Design Project: The Headworks Condition Assessment/Concept Design project was completed in FY10 at a cost of about \$700,000 to establish a basis for headworks improvements/upgrades and prioritization of rehabilitation/replacement projects and operational processes for three remote headworks facilities (Chelsea Creek, Columbus Park, and Ward Street). Recommendations from this study, together with additional MWRA planning, resulted in the sequencing of follow-up design/construction projects that target upgrades for the three older remote headworks facilities from the present through FY22. The resulting design/construction projects that target upgrades for the three headworks (first Chelsea Creek Headworks and second the combined Ward Street/Columbus Park Headworks project) are programmed in the FY14 CIP at a total cost of over \$164 million.

8.03 Chelsea Creek Headworks

- Address: 340 Marginal Street, Chelsea
- Location Map: See Figure 8-1
- Tributary Area Map: See Figure 8-2
- Average Daily Flow: 135 mgd
- Peak Capacity: 350 mgd

Facility Function and Operation: The Chelsea Creek Headworks (built in 1967) was placed into operation in 1968 with a

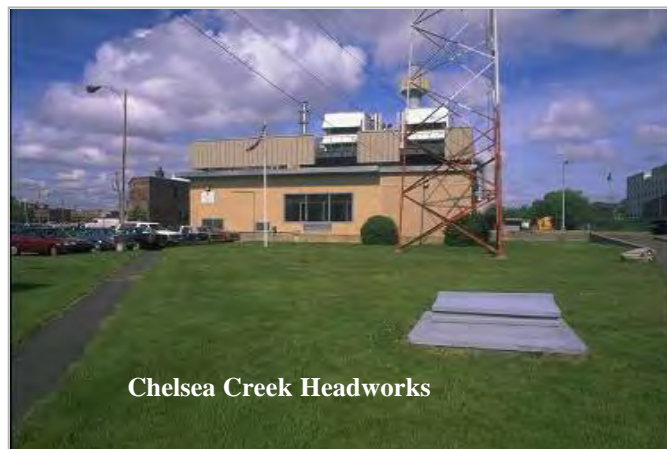

Chelsea Creek Headworks

major equipment upgrade (fast-track improvements) constructed by MWRA in 1987. The facility provides screening and grit removal, flow metering, and flow control for Deer Island's North Main Pump Station. The facility receives flow from the North Metropolitan Trunk Sewer and North Metropolitan Relief Sewer. Flows in the East Boston Branch Sewer, East Boston Low Level Sewer, Chelsea Branch Sewer, and Revere Branch Sewer, normally tributary to the Caruso Pump Station, can also reach Chelsea Creek Headworks via the Chelsea Screen House/Chelsea Creek Siphons. Flow passing through the headworks exits via a drop shaft into the North Metropolitan Relief Tunnel which crosses under Boston Harbor and connects to the North Main Pump Station at Deer Island. Excess flows tributary to the Chelsea Creek Headworks are designed to overflow a side weir, pass through the Chelsea Screen House, and be conveyed to the Caruso Pump Station via one of the two Chelsea Creek Siphon barrels. However, this is dependent on the pumping rate of the Caruso Pump Station which in turn is limited by the Winthrop Terminal Facility. The Chelsea Creek Headworks serves sixteen north system communities. The tributary area is comprised of separate sanitary sewers, with some combined sewer areas in Cambridge, Chelsea, and Somerville.

Facility Components: Major facility components include: four hydraulic influent sluice gates, four mechanical bar screens, four grit channels with flight chain collectors, four critical depth flumes with flow meters, four hydraulic effluent sluice gates, odor control equipment and an emergency generator.

Hydraulic Performance: Four channels are available for use at the Chelsea Creek Headworks. Typically, two channels are used during normal (dry weather) flow conditions and three channels are used during peak flow (wet weather) conditions, with one channel held in reserve. Flow entering the facility may be limited by the peak hydraulic capacity of the downstream North Metropolitan Relief Tunnel and pumping capacity at the North Main Pump Station. A third channel is typically brought on line at 200 mgd in anticipation of a large storm. The facility will throttle the influent gates to regulate the amount of flow through the facility. This throttling is referred to as "choking." Choking of the gates will initially divert excess flow to the Chelsea Screen House, which is tributary to the Caruso Pump Station. Once Caruso Pump Station reaches its peak capacity, the hydraulic grade line will increase in the North Metropolitan System and activate the upstream CSO outfalls.

Facility Power: The primary electrical feed is from commercial service. A diesel generator (200 KW) provides backup power. The generator was replaced as part of the 1987 fast track improvements and is in good condition.

Standard Operating Procedures (SOPs): The facility SOP was developed in 1987 and has received periodic updates.

Record Plans: Record Drawings for the 1987 upgrades for the Chelsea Creek Headworks (MWRA Contract No. S82-1020-C3A) have accession numbers 10526 through 10585. Design Drawings for the original construction for the Chelsea Creek Headworks (Contract No. 216) have accession numbers 56201 through 56296. Design Drawings for furnishing and delivering equipment (Contract No. 253) have accession numbers 57001 through 57012.

Condition Assessment and Ongoing Upgrades: The Chelsea Creek Headworks is operational, but (largely due to age and equipment obsolescence) is in only fair condition and needs

significant reinvestment in the immediate future. The facility structure is 45 years old and most equipment is 25 years old. Based on the industry useful life benchmark of 50 years for structure and 20 years for equipment, upgrades are warranted. A Condition Assessment/Concept Design project was completed in FY10 to establish a basis for future headworks upgrades. During this project, a complete inventory of the components in the headworks was developed, the physical and performance condition of the components was evaluated, and components were recommended for replacement and upgrade. The assessment was comprehensive and included the mechanical bar screens, grit removal, odor control, chemical systems, HVAC, electrical systems and emergency generators, instrumentation and control, plumbing, all gates and pumps, lighting, roofing, structural and architectural components, and the site. A strategy for uninterrupted wastewater services during future construction, construction scheduling, and cost estimates for replacement and upgrade of all components and equipment were developed.

Projects Programmed in the FY14 CIP:

- Chelsea Creek Headworks Upgrade – design, construction administration, and resident engineering and inspection during construction at a cost of \$7.072 million in FY14-19. This project began in FY11. The Chelsea Creek Headworks was identified as having a “High Risk” (likely affected by a 100 year flood) in the “Report on Severe Weather Preparedness for MWRA Coastal Facilities” as presented in a Staff Summary at the October 16, 2013 Board of Directors meeting (see details in that report). The flood risk for the Chelsea Creek Headworks and MWRA’s benchmark of the current 100 year flood elevation plus an additional 2.5 feet to account for sea level rise and more severe storms should be evaluated as part of the Upgrade Design project.
- Chelsea Creek Headworks Upgrade – construction at \$52.050 million in FY15-19.

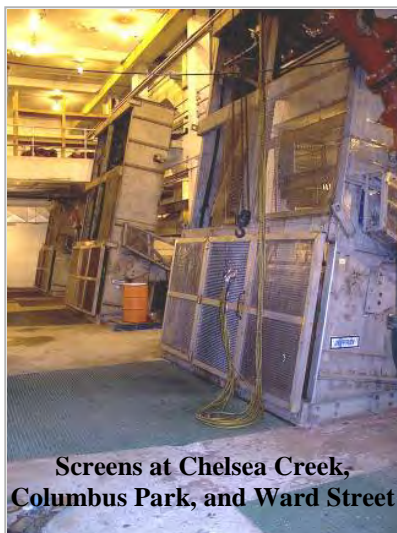

These photos show the screening system typical of all three older remote headworks – Chelsea Creek, Columbus Park and Ward Street. The screening systems are in need of replacement.

Project Recommended for Consideration in Future CIPs:

- A Long-term Wastewater Facilities Asset Protection Project is recommended for the remote headworks (see Section 8.09) at an annual budget of \$1.0 million for the FY24-53 period. The total project cost is projected at \$30.0 million over 30 years. A portion of these funds would be used for rehabilitation/replacement needs at the Chelsea Creek Headworks.

8.04 Columbus Park Headworks

- Address: 1305 Columbus Road, South Boston
- Location Map: See Figure 8-1
- Tributary Area Map: See Figure 8-2
- Average Daily Flow: 40 mgd
- Peak Capacity: 182 mgd



Columbus Park Headworks

Facility Function and Operation: The Columbus Park Headworks (built in 1967) was placed into operation in 1968 with a major equipment upgrade (fast-track improvements) constructed by MWRA in 1987. The facility provides screening and grit removal, flow metering, and flow control for Deer Island's North Main Pump Station. The facility receives flow from the Columbus Park Connection (via the New Boston Main Interceptor and Dorchester Interceptor) and the South Boston Interceptor system. Flow passing through the headworks exits via a drop shaft into the Boston Main Drainage Tunnel which crosses under Boston Harbor and connects to the North Main Pump Station at Deer Island. Upstream of the Columbus Park Headworks, the Ward Street Headworks also discharges to the Boston Main Drainage Tunnel. The tributary area includes flow from a large portion of Boston and a very small portion of Milton and is comprised of both combined and separate sanitary sewers.

Facility Components: Major facility components include: four hydraulic influent sluice gates, four mechanical bar screens, four grit channels with flight chain collectors, four critical depth flumes with flow meters, four hydraulic effluent sluice gates, odor control equipment and an emergency generator.

Hydraulic Performance: Four channels are available for use at the Columbus Park Headworks. Typically, two channels are used during normal (dry weather) flow conditions and three channels are used during peak flow (wet weather) conditions, with one channel held in reserve. The combined capacity of the Columbus Park and Ward Street Headworks equals the conveyance capacity of the Boston Main Drainage Tunnel (438 mgd). During significant storm events that exceed the capacity of the Columbus Park Headworks, the influent sluice gates can be choked to prevent flooding of the facility. If the influent flow is choked, a backwater condition can increase discharge at upstream CSO outfalls.

Facility Power: The primary electrical feed is from commercial service. A diesel generator (200 KW) provides backup power. The generator was replaced as part of the 1987 fast track improvements and is in good condition.

Standard Operating Procedures (SOPs): The facility SOP was developed in 1987 and has received periodic updates.

Record Plans: Record Drawings for the 1987 upgrades for the Columbus Park Headworks (MWRA Contract No. S82-1020-C3A) have accession numbers 10466 through 10525. Design Drawings for the original construction for the Columbus Park Headworks (Contract No. C-215) have accession numbers 56101 through 56187. Design Drawings for furnishing and delivering equipment (Contract No. C-255) have accession numbers 57025 through 57031.

Condition Assessment and Ongoing Upgrades: The Columbus Park Headworks is operational, but largely due to age and equipment obsolescence is in only fair condition and needs significant reinvestment in the immediate future. The facility structure is 45 years old and most equipment is 25 years old. Based on the industry useful life benchmark of 50 years for structures and 20 years for equipment, upgrades are warranted. A Condition Assessment/Concept Design project was completed in FY10 to establish a basis for future headworks upgrades. During this project, a complete inventory of the components in the headworks was developed, the physical and performance condition of the components was evaluated, and components were recommended for replacement and upgrade. The assessment was comprehensive and included the mechanical bar screens, grit removal, odor control, chemical systems, HVAC, electrical systems and emergency generator, instrumentation and control, plumbing, all gates and pumps, lighting, roofing, structural and architectural components, and the site. A strategy for uninterrupted wastewater services during future construction, construction scheduling, and costs estimates for replacement and upgrade of all components and equipment were developed.



Photos show grit piping and grit collection pod typical of all three older remote headworks – Chelsea Creek, Columbus Park and Ward Street. The grit removal systems are in need of replacement.



The photo at left shows the odor control media typical of all three older remote headworks – Chelsea Creek, Columbus Park and Ward Street. The odor control systems are in need of replacement.

Projects Programmed in the FY14 CIP:

- Ward Street Headworks and Columbus Park Headworks Upgrade – design, construction administration, and resident engineering and inspection during construction at a cost of \$9.747 million in FY16-22.
- Ward Street Headworks and Columbus Park Headworks Upgrade – construction at \$95.330 million in FY19-22.

Project Recommended for Consideration in Future CIPs:

- A Long-term Wastewater Facilities Asset Protection Project is recommended for the remote headworks (see Section 8.09) at an annual budget of \$1.0 million for the FY24-53 period. The total project cost is projected at \$30.0 million over 30 years. A portion of these funds would be used for rehabilitation/replacement needs at the Columbus Park Headworks.

8.05 Ward Street Headworks

- Address: 47 Ward Street, Roxbury
- Location Map: See Figure 8-1
- Tributary Area Map: See Figure 8-2
- Average Daily Flow: 90 mgd
- Peak Capacity: 256 mgd

Facility Function and Operation: The Ward Street Headworks (built in 1967) was placed into operation in 1968 with a major equipment upgrade (fast-track improvements) constructed by MWRA in 1987. The facility provides screening and grit removal, flow metering, and flow control for Deer Island's North Main Pump Station. The facility receives flow from the Boston Main Drainage Relief Sewer, Charles River Valley Sewer, South Charles Relief Sewer, North Charles Metro Sewer, and North Charles Relief Sewer. Flow passing through the headworks exits via a drop shaft into the Boston Main Drainage Tunnel which crosses under Boston Harbor and connects to the North Main Pump Station at Deer Island. Downstream of the Ward Street Headworks, the Columbus Park Headworks also discharges to the Boston Main Drainage Tunnel. The Ward Street Headworks tributary area includes flow from Belmont, Boston, Cambridge, Newton, Waltham, and Watertown and is comprised of both combined and separate sanitary sewers.



Site History: The Ward Street Headworks occupies the site adjacent to the original Ward Street Pump Station that was constructed in 1901 and decommissioned when the Ward Street Headworks and Boston Main Drainage Tunnel were constructed. The Ward Street Pump Station discharged flow to the High Level Sewer via two 48-inch force mains.

Facility Components: Major facility components include: four hydraulic influent sluice gates, four mechanical bar screens, four grit channels with flight chain collectors, four critical depth flumes with flow meters, four hydraulic effluent sluice gates, odor control equipment and an emergency generator.

Hydraulic Performance: Four channels are available for use at the Ward Street Headworks. Typically, two channels are used during normal (dry weather) flow conditions and three channels are used during peak flow (wet weather) conditions, with one channel held in reserve. The combined capacity of the Ward Street and Columbus Park Headworks equals the conveyance capacity of the Boston Main Drainage Tunnel (438 mgd). During significant storm events that exceed the capacity of the Ward Street Headworks, the influent sluice gates can be choked to prevent flooding of the facility. If the influent flow is choked, a backwater condition can increase flow to the Cottage Farm CSO Facility.

Facility Power: The primary electrical feed is from commercial service. A diesel generator (820 KW) provides backup power. The generator was replaced as part of the 1987 fast track improvements and is in good condition.

Standard Operating Procedures (SOPs): The facility SOP was developed in 1987 and has received periodic updates.

Record Plans: Record Drawings for the 1987 upgrades for the Ward Street Headworks (MWRA Contract No. S82-1020-C3A) have accession numbers 10586 through 10645. Design Drawings for the original construction for the Ward Street Headworks (Contract No. C-213) have accession numbers 56001 through 56089. Design Drawings for furnishing and delivering equipment (Contract No. 254) have accession numbers 57013 through 57019.

Condition Assessment and Ongoing Upgrades: The Ward Street Headworks is operational, but largely due to age and equipment obsolescence is in only fair condition and needs significant reinvestment in the immediate future. The facility structure is 45 years old and most equipment is 25 years old. Based on the industry useful life benchmark of 50 years for structures and 20 years for equipment, upgrades are warranted. A Condition Assessment/Concept Design project was completed in FY10 to establish a basis for future headworks upgrades. During this project, a complete inventory of the components in the headworks was developed, the physical and performance condition of the components was evaluated, and components were recommended for replacement and upgrade. The assessment was comprehensive and included the mechanical bar screens, grit removal, odor control, chemical systems, HVAC, electrical systems and emergency generators, instrumentation and control, plumbing, all gates and pumps, lighting, roofing, structural and architectural components, and the site. A strategy for uninterrupted wastewater services during future construction, construction scheduling, and costs estimates for replacement and upgrade of all components and equipment were developed.

Projects Programmed in the FY14 CIP:

- Ward Street Headworks and Columbus Park Headworks Upgrade – design, construction administration, and resident engineering and inspection during construction at a cost of \$9.747 million in FY16-22.
- Ward Street Headworks and Columbus Park Headworks Upgrade – construction at \$95.330 million in FY19-22.

Project Recommended for Consideration in Future CIPs:

- A Long-term Wastewater Facilities Asset Protection Project is recommended for the remote headworks (see Section 8.09) at an annual budget of \$1.0 million for the FY24-53 period. The total project cost is projected at \$30.0 million over 30 years. A portion of these funds would be used for rehabilitation/replacement needs at the Ward Street Headworks.

8.06 Nut Island Headworks

- Address: 147 Sea Avenue, Quincy
- Location Map: See Figure 8-1
- Tributary Area Map: See Figure 8-2
- Average Daily Flow: 125 mgd
- Peak Capacity: 400 mgd



Facility Function and Operation: The Nut Island Headworks was placed into operation in 1998. The facility provides screening and grit removal, flow metering, and flow control

for Deer Island's Lydia Goodhue (South System) Pump Station. The facility receives flow from the High Level Sewer which carries flow from almost the entire MWRA south collection system (except for flow that passes through the Intermediate Pump Station and is pumped directly to the Inter-Island Tunnel). Flow passing through the Nut Island Headworks exits via a drop shaft into the Inter-Island Tunnel which crosses under Boston Harbor and connects to Deer Island. Excess flows tributary to the Nut Island Headworks are designed to overflow an emergency storage weir. Approximately 2.7 million gallons of storage is available, which will provide approximately 11 minutes of detention at 360 mgd. Once the storage capacity is exceeded, additional relief can be provided by manually activating the three Nut Island emergency outfalls. If the three outfalls do not provide adequate relief, the four emergency spillway gates may be opened to provide the necessary relief. Discharge through the three emergency outfalls must comply with regulations for DITP bypasses. The Nut Island Headworks serves twenty-two south system communities. The tributary area is comprised of separate sanitary sewers.

Facility Components: Major facility components include: six hydraulic influent sluice gates, six mechanical bar screens, six manual screen effluent sluice gates, six manual grit chamber main channel influent sluice gates, six electric grit chamber influent channel sluice gates, six vortex type grit chambers with air lift grit pump collectors, two hydraulic headworks effluent sluice gates, two motorized outfall sluice gates, four motorized emergency spillway sluice gates, ultrasonic level sensor in the effluent drop shaft and an emergency generator.

Recent Facility Upgrades: The fire alarm system at the Nut Island Headworks was replaced with an upgraded system in FY10.

Site History: The Nut Island Headworks occupies the site of the original Nut Island Treatment Plant that was constructed in 1952 and decommissioned when the Nut Island Headworks and Inter-Island Tunnel were constructed and placed into operation in 1998. The Nut Island Treatment Plant served all of the south collection system providing preliminary and primary treatment and chlorination prior to discharge through the three effluent outfalls. The original treatment plant effluent outfalls were retained for use as emergency outfalls for the Nut Island Headworks.

Hydraulic Performance: Six channels are available for use at the Nut Island Headworks. Typically, two or three channels are used during normal (dry weather) flow conditions and five channels used during peak flow (wet weather) conditions, with one channel held in reserve. Flow entering the facility may be limited by the peak hydraulic capacity of the downstream Inter-Island Tunnel and pumping capacity at the Deer Island's Lydia Goodhue (South System) Pump Station. During peak flow conditions, coordination between the Nut Island Headworks and Intermediate Pump Station is critical, since both discharge to the Inter-Island Tunnel.



Emergency Spillway: The function of these 8x8-foot sluice gates is to enable flow to be routed directly to Hingham Bay once emergency storage is fully utilized and the headworks is operating at maximum capacity, or if the headworks had to be isolated for an emergency condition (such as a failure at the Lydia Goodhue South System Pump Station).

Emergency Outfalls: Three emergency outfalls exist from the former Nut Island Treatment Plant. These three outfalls discharge to Quincy Bay and can be activated in an emergency.

- Section 543, 5275 feet of 5-foot diameter cast iron pipe built in 1904;
- Section 543-A, 5545 feet of 5-foot diameter cast iron pipe built in 1904; and
- Section 543-B, 1395 feet of 5-foot diameter cast iron pipe built in 1914.

Nut Island Pier: A commercial/industrial pier was built as part of the new Headworks Construction project. It was used for construction equipment and supply access to Nut Island and will be maintained for future MWRA needs. It is also currently used for recreational purposes by the public.

Facility Power: The primary electrical feed is from commercial service. A diesel generator (820 KW) provides backup power. The generator was installed in 1998 and is in good condition. An upcoming FY12-13 CEB project will modify the power supply to the generator cooling fan. The fan will be powered from the generator and not a facility motor control center.

Standard Operating Procedures (SOPs): The facility SOP was developed in 1998 and has received periodic updates.

Record Plans: There are 408 record drawings under MWRA Contract 5858 (Boston Harbor Project (BHP)CP-152). The dates of the record drawings are 1991-1992. The drawings do not have accession numbers because BHP used a different numbering system for record drawings (see Chapter 6).

Condition Assessment and Ongoing Upgrades: The Nut Island Headworks is relatively new (1998) and in good condition. Some repair work to maintain system/equipment operation and mechanical and electrical systems is recommended (see project list below).

Projects Programmed in the FY14 CIP:

- Design and construction of improvements to the electrical system and grit/screenings conveyance system at the Nut Island Headworks began in March 2011. The electrical system is subject to groundwater infiltration and the grit/screenings conveyance system has alignment and operational problems. The Nut Island Headworks electrical and grit/screenings conveyance system – design and construction project is programmed in the FY14 CIP as a 3 year project; \$8.518 million remains to be spent in FY14-16.
- Portions of the mechanical and electrical systems at the Nut Island Headworks are failing or are expected to reach the end of their useful life in the immediate future. Electrical systems are being evaluated through service contract maintenance which may reveal obsolescence and/or potential for future failure. Mechanical systems have exhibited operation and maintenance problems. The Nut Island Headworks mechanical and electrical replacements (planning, design, and construction) project is programmed in the FY14 CIP as a 4 year project during FY17-20 at \$3.0 million.
- A study to determine the cause of settlement of the fire pump building at the Nut Island Headworks is planned. The study will review damage to the building structure and underground interconnecting utilities and develop recommendations for stabilization and rehabilitation. The Nut Island Headworks fire pump building study is programmed in the FY14 CIP as a 3 year project during FY14-16 at \$600,000.
- Odor control at the Nut Island Headworks is currently being reliably performed using a carbon system. Modifications to the current system are planned to improve long term performance and ability to quickly transfer to a backup system. Improvements are intended to avoid air quality violations and odor complaints. The Nut Island Headworks odor control system – evaluation and design project is programmed in the FY14 CIP as a 3 year project during FY15-17 at \$1.0 million.

Projects Recommended for Consideration in Future CIPs:

- A Long-term Wastewater Facilities Asset Protection Project is recommended for the remote headworks (see Section 8.09) at an annual budget of \$1.0 million for the FY24-53 period. The total project cost is projected at \$30.0 million over 30 years. A portion of these funds would be used for rehabilitation/replacement needs at Nut Island Headworks.
- The Nut Island Pier is anticipated to require rehabilitation in the future. A \$500,000 planning, design, construction project is recommended with a project duration of 2 years during the FY20-21 time frame.

- The Nut Island Headworks has a total replacement asset value of \$120 million in 2006 dollars. About \$48 million (40 percent of \$120 million) of the total replacement asset value can be allocated to equipment type needs. Based on the industry benchmark of 20 year asset useful life for equipment type components at the Nut Island Headworks, staff recommends an anticipated expenditure of \$30 million during the FY29-38 timeframe. The recommended \$30 million represents only a portion of the total \$48 million equipment replacement asset value, since it is assumed that some of the Nut Island equipment will be rehabilitated/replaced in the short term via planned projects. About \$72 million (60 percent of \$120 million) of the total replacement asset value can be allocated to structural type needs. Based on the industry benchmark of 50 year asset useful life for structural type components, expenditures for structural type components at the Nut Island Headworks should be planned during the next update of the 40 year Wastewater System Master Plan.

8.07 Intermediate Pump Station

The Intermediate Pump Station (IPS) is located at 50 Bridge Street in North Weymouth and was placed into operation in December 2004. Wastewater is pumped from the IPS into a 42-inch force main and conveyed through the Braintree-Weymouth Tunnel directly to the Inter-Island Tunnel, and ultimately to the Deer Island Treatment Plant. Wastewater flow pumped at the IPS bypasses the Nut Island Headworks, therefore, separate headworks process equipment (screens and grit removal) are an integral part of the IPS. Details on the IPS are included within Chapter 10 – Collection System Pump Stations and CSO Facilities.

Concurrent with the construction of the IPS, the Braintree-Weymouth Tunnel was constructed to link Nut Island in Quincy, the IPS in Weymouth, and MWRA’s residuals processing facility at the Fore River Staging Area in Quincy. The Braintree-Weymouth Tunnel is detailed in Section 8.13.

8.08 Winthrop Terminal Headworks

The Winthrop Terminal Headworks is located at the Deer Island Treatment Plant. It is not considered a “remote” headworks. It is an integral part of the Deer Island Treatment Plant facilities and is detailed within Chapter 6 - Deer Island Treatment Plant.

8.09 Remote Headworks Long-term Reinvestment Needs Based on Estimated Replacement Asset Value

For the 2006 Master Plan, MWRA staff spent several months developing a replacement cost valuation of MWRA’s infrastructure using MWRA-specific appraisal data and actual MWRA project cost information (see Section 3.07). Staff estimate MWRA’s headworks facilities have a replacement asset value of \$190 million in 2006 dollars. Staff then applied industry benchmarks for asset useful life (50 years for structural components and 20 years for equipment components) to estimate reinvestment needs. For the headworks, 60 percent of the asset value was allocated as structural (50 year useful life) components and 40 percent of the asset value was allocated as equipment (20 year useful life) components. Using the allocated asset value and dividing by the expected useful life produces an overall estimated reinvestment need of \$6 million per year for

the headworks facilities. It is assumed that the majority of this reinvestment need will be met via specific large-scale headworks rehabilitation/replacement projects similar to those programmed into the CIP. These large scale projects are fully detailed, evaluated, and justified within MWRA's annual CIP process. However, a portion of the long-term reinvestment need is likely to be met via small-scale rehabilitation/replacement projects that, individually, may be difficult to identify/justify within the annual CIP process. To provide for small-scale rehabilitation/replacement projects at the headworks, a long-term Wastewater Facilities Asset Protection Project is recommended for consideration in future CIPs at an annual cost of \$1.0 million per year (about 16 percent of the headworks overall estimated annual reinvestment need) during the FY24-53 timeframe; a total cost of \$30.0 million over 30 years. Planning should consider potential increases in flood elevations and tidal surge due to impacts from climate change. Similar long-term asset protection funds are recommended separately for pump station and CSO facilities (in Chapter 10).

Staff estimate that MWRA's 19 miles of Cross-Harbor Tunnels have a replacement asset value of \$660 million in 2006 dollars. The industry benchmarks for asset useful life for tunnels is 100+ years. The two older cross-harbor tunnels, the Boston Main Drainage Tunnel and North Metropolitan Relief Tunnel (each built in the 1950s), have reached approximately half of their estimated useful lives. The Inter-Island Tunnel has only recently (1998) come into service. The expected useful life of the cross-harbor tunnels extends to the end of the 40 year planning period of the Wastewater System Master Plan. Based on this, a place holder for future expenditures anticipated to be required for evaluation and rehabilitation of the cross-harbor tunnels is recommended for consideration in future CIPs at a cost of \$50.0 million during the FY46-50 (long-term) timeframe. Projects to inspect/assess the tunnels, as well as to repair concrete corrosion in the tunnel shafts, are programmed in the FY14 CIP. Once these projects are complete, recommendations for future cross-harbor tunnel capital improvements should be more defined and will be more detailed in future updates of the Wastewater System Master Plan.

8.10 Boston Main Drainage Tunnel

Function and Operation: The Boston Main Drainage Tunnel was constructed in 1953. The tunnel location is shown on Figure 8-1. The Boston Main Drainage Tunnel receives flow from the Ward Street and Columbus Park Headworks, crosses under Boston Harbor, and connects to Shaft "C" and the North Main Pump Station at the Deer Island Treatment Plant. The tunnel is MWRA Sewer Section 174, is constructed of reinforced concrete and has a total length of 37,586 feet (about 7.1 miles) from the Ward Street Headworks effluent shaft to Shaft "C" at Deer Island. The portion from the Ward Street Headworks to Columbus Park Headworks is 10-foot diameter and 13,763 feet long. The portion from the Columbus Park Headworks to Shaft "C" at Deer Island is 11.5-foot diameter and 23,823 feet long. An additional 167-feet of 10-foot diameter tunnel connects Shaft "C" to the North Main Pump Station, however, this portion is part of the North Metropolitan Relief Tunnel.

Hydraulic Performance: The capacity of the Boston Main Drainage Tunnel is 438 mgd. Flow through the Boston Main Drainage Tunnel is controlled by pumping at the North Main Pump Station at the Deer Island Treatment Plant. Flow into the tunnel can be controlled by choking (throttling of influent gates) at the Ward Street and Columbus Park Headworks.

Record Plans: The drawings are from Construction Contract 210 with accession numbers 29183, 29119, 54531 to 54549.

Condition Assessment and Ongoing Upgrades: The existing condition of the Boston Main Drainage Tunnel is unknown. Based on the industry benchmark of 100+ years for useful life for tunnels, it is presumed that the tunnel is in good condition. Field Operations has documented concrete corrosion (due to hydrogen sulfide) in the headworks effluent/cross-harbor tunnel drop shafts. There is concern that concrete falling into the drop shafts could cause pumping problems at Deer Island. An effluent shaft study and follow-up study, design, construction project for cross-harbor tunnel inspection and shaft repairs are programmed in the FY14 CIP.

Projects Programmed in the FY14 CIP:

- Field Operations has documented concrete corrosion (due to hydrogen sulfide) in the three cross-harbor tunnel drop shafts at the Chelsea Creek, Columbus Park, and Ward Street Headworks. The Headworks Effluent Shaft Study is programmed in the FY14 CIP as a 2 year project during FY16-17 at a cost of \$500,000. The study will also evaluate shaft ventilation. Information developed during this study will help shape the Cross-Harbor Tunnel Inspection/Condition Assessment and Shaft Repair project detailed below.
- A Cross-Harbor Tunnel Inspection/Condition Assessment and Shaft Repair project is programmed in the FY14 CIP at a cost of \$5.0 million and a 3 year project duration during FY19-21. The project will include evaluation of three cross-harbor tunnels: the Boston Main Drainage Tunnel, the North Metropolitan Relief Tunnel, and the Inter-Island Tunnel, as well as, repair of the shafts based on information from the Headworks Effluent Shaft Study project.



Photos above show the watertight door access at the tunnel shaft and hydrogen sulfide corrosion of concrete walls and steel grate that covers the tunnel shaft. Repair of concrete corrosion in the tunnel shafts is needed.

Projects Recommended for Consideration in Future CIPs:

- A Cross-Harbor Tunnel Inspection, Condition Assessment and Cleaning/Rehabilitation project is recommended for consideration in future CIPs as a long-term place holder for future expenditures anticipated to be required for evaluation and rehabilitation of the cross-harbor tunnels. A 5 year project duration during FY46-50 at a cost of \$50.0 million is recommended.

8.11 North Metropolitan Relief Tunnel

Function and Operation: The North Metropolitan Relief Tunnel was constructed in 1953. The tunnel location is shown on Figure 8-1. The North Metropolitan Relief Tunnel receives flow from the Chelsea Creek Headworks, crosses under Boston Harbor, and connects to Shaft No. 1 and the North Main Pump Station and Shaft “C” at the Deer Island Treatment Plant. The 10-foot diameter tunnel is MWRA Sewer Section 210, is constructed of reinforced concrete and has a total length of 20,773 feet (about 3.9 miles).

Hydraulic Performance: The capacity of the North Metropolitan Relief Tunnel is 350 mgd. Flow through the North Metropolitan Relief Tunnel is controlled by pumping at the North Main Pump Station at the Deer Island Treatment Plant. Flow into the tunnel can be controlled by choking (throttling of influent gates) at the Chelsea Creek Headworks.

Record Plans: There are two Construction Contracts (180 and 190, dated 1949-1952) with a total of 61 drawings. There are accession numbers in 10 different series, non-sequential, that are indexed to the two contracts.

Condition Assessment and Ongoing Upgrades: The existing condition of the North Metropolitan Relief Tunnel is unknown. Based on the industry benchmark of 100+ years for useful life for tunnels, it is presumed that the tunnel is in good condition. Field Operations has documented concrete corrosion (due to hydrogen sulfide) in the headworks effluent/cross-harbor tunnel drop shafts. There is concern that concrete falling into the drop shafts could cause pumping problems at Deer Island. An effluent shaft study and follow-up study, design, construction project for cross-harbor tunnel inspection and shaft repairs are programmed in the FY14 CIP.

Projects Programmed in the FY14 CIP and Recommended for Consideration in Future CIPs:

- CIP Projects for the North Metropolitan Relief Tunnel are the same as those presented in Section 8.10 under the Boston Main Drainage Tunnel.

8.12 Inter-Island Tunnel

Function and Operation: Construction for the Inter-Island Tunnel began in 1996 and it was placed into operation in July 1998. The tunnel’s location is shown on Figure 8-1. The Inter-Island Tunnel receives flow from the Nut Island Headworks and the Intermediate Pump Station (IPS), crosses under Boston Harbor, and connects to the Deer Island Lydia Goodhue (South System) Pump Station. There is an access drop shaft to the tunnel at Long Island. This access shaft is also used as a wastewater connection for BWSC. The 11.5-foot diameter tunnel is MWRA Sewer Section 682, is constructed of reinforced concrete, and has a total length of 25,296 feet (about 4.8 miles). The Inter-Island Tunnel contains two 14-inch ductile iron sludge force mains from the Deer Island Treatment Plant to Nut Island. The Braintree-Weymouth Tunnel connects from the Inter-Island Tunnel at Nut Island to the IPS in Weymouth and also to the MWRA’s Residuals Processing Facility at the Fore River Staging Area in Quincy.

Hydraulic Performance: The capacity of the Inter-Island Tunnel is 400 mgd. Flow through the Inter-Island Tunnel is controlled by pumping at Deer Island’s Lydia Goodhue (South System)

Pump Station. Flow into the tunnel can be controlled by influent gates and operation of the emergency facilities (outfalls and spillway) at the Nut Island Headworks.

Record Plan: There are 43 record drawings under MWRA Contract 5541 (Boston Harbor Project (BHP) CP-151), dated 1999. The drawings do not have accession numbers because BHP used a different numbering system for record drawings (see Chapter 6).

Condition Assessment and Ongoing Upgrades: The existing condition of the Inter-Island Tunnel is unknown. The tunnel was placed into operation less than 10 years ago. Based on the industry benchmark of 100+ years for useful life for tunnels, it is presumed that the tunnel is in very good condition. An effluent shaft study and follow-up study, design, construction project for cross-harbor tunnel inspection and shaft repairs are programmed in the FY14 CIP.

Projects Programmed in the FY14 CIP and Recommended for Consideration in Future CIPs:

- CIP projects for the Inter-Island Tunnel are the same as those presented in Section 8.10 under the Boston Main Drainage Tunnel.

8.13 Braintree-Weymouth Tunnel

Function and Operation: Concurrent with the construction of the Intermediate Pump Station (IPS) in 2005, the Braintree-Weymouth Tunnel was constructed to link Nut Island in Quincy, the IPS in Weymouth, and MWRA's Residuals Processing Facility at the Fore River Staging Area in Quincy. The location of the tunnel is shown on Figure 8-1. The Braintree-Weymouth Tunnel connects from the Inter-Island Tunnel at Nut Island to the IPS in Weymouth and also to the MWRA's Residuals Processing Facility at the Fore River Staging Area in Quincy. The Braintree-Weymouth Tunnel contains:

- 2 - 14-inch ductile iron sludge force mains from Nut Island in Quincy to the Residuals Processing Facility in Quincy, a distance of 2.5 miles;
- 2 - 12-inch ductile iron centrate force mains from the Residuals Processing Facility in Quincy to the IPS in Weymouth, a distance of 0.5 mile;
- 1 - 12-inch ductile iron potable water line from the Residuals Processing Facility in Quincy to the IPS in Weymouth, a distance of 0.5 mile;
- 1 - 42-inch ductile iron raw wastewater force main from the IPS in Weymouth to the Inter-Island Tunnel beneath Nut Island in Quincy, a distance of 2.0 miles; and,
- At Nut Island, there is a chamber with air/vacuum relief valves for both sludge force mains.

Record Plan: Record plans for the Braintree/Weymouth Tunnel have accession numbers 201958 to 201984.

Condition Assessment and Ongoing Upgrades: The Braintree-Weymouth Tunnel is relatively new. No upgrades are ongoing.

Projects Recommended for Consideration in Future CIPs: None. The Braintree-Weymouth Tunnel is not included within the Cross-Harbor Tunnel Inspection and Condition Assessment project because the tunnel is backfilled with grout that secures the internal piping. The internal piping should be inspected as part of MWRA's force main program (see Section 9.09).

8.14 Summary of Existing and Recommended Capital Projects

All Master Plan projects related to collection system headworks and cross-harbor tunnels are summarized in this Section. Table 8-2 lists each project, its priority ranking, and the proposed expenditure schedule. The needs justification for each project has been detailed previously in the Chapter within Sections relating to specific facilities or asset types.

Projects in the FY14 CIP: There are ten headworks and cross-harbor tunnel related projects programmed in the FY14 CIP. The projects are described below and summarized in Table 8-2 (see line numbers 8.01 and 8.10).

- The Chelsea Creek Headworks Upgrade – design, construction administration, and resident engineering and inspection during construction project began in FY11. A remaining cost of \$7.072 million is programmed in the FY14 CIP for expenditure during FY14-19.
- The Chelsea Creek Headworks Upgrade – construction project is programmed in the FY14 CIP during FY15-19 at a cost of \$52.050 million.
- The Ward Street Headworks and Columbus Park Headworks Upgrade – design, construction administration, and resident engineering and inspection during construction project is programmed in the FY14 CIP during FY16-22 at a cost of \$9.747 million.
- The Ward Street Headworks and Columbus Park Headworks Upgrade – construction project is programmed in the FY14 CIP during FY19-22 at a cost of \$95.330 million.
- The Nut Island Headworks Electrical and Grit/Screenings Conveyance – design and construction project began in FY11. A remaining cost of \$8.518 million is programmed in the FY14 CIP for expenditure in FY14-16.
- The Nut Island Mechanical and Electrical Systems Replacement project is programmed in the FY14 CIP during FY17-20 at a cost of \$3.0 million.
- The Nut Island Fire Pump Building Study project is programmed in the FY14 CIP during FY14-16 at a cost of \$600,000.
- The Nut Island Odor Control System evaluation and design project is programmed in the FY14 CIP during FY15-17 at a cost of \$1.0 million.
- The Headworks Effluent Shaft study project is programmed in the FY14 CIP during FY16-17 at a cost of \$500,000.
- The Cross-Harbor Tunnel Inspection and Shaft Repairs – planning, design, and construction project is programmed in the FY14 CIP during FY19-21 at a cost of \$5.0 million.

Projects Recommended for Consideration in Future CIPs: There are four headworks and cross-harbor tunnel related projects recommended for consideration in future CIPs. The projects are described below and summarized in Table 8-2 (see line numbers 8.11 through 8.14).

- A Long-Term Wastewater Facilities Asset Protection project for the remote headworks is recommended at an annual budget of \$1.0 million per year for expenditures in FY24-53 for a total 30-year cost of \$30.0 million. This project will provide annual baseline target expenditures for asset protection projects for the remote headworks facilities.
- The Nut Island Pier Rehabilitation planning, design, and construction project is recommended for a 2 year project duration during FY20-21 at a cost of \$500,000.
- The Nut Island Headworks Future Equipment Replacement project is recommended for a 10 year duration during FY29-38 at a cost of \$30.0 million.
- A Cross-Harbor Tunnel Inspection, Condition Assessment and Cleaning/Rehabilitation project is recommended as a long-term place holder for future expenditures anticipated to be required for evaluation and rehabilitation of the cross-harbor tunnels. A 5 year project duration during FY46-50 at a cost of \$50 million is recommended.

**Table 8-2
Wastewater Master Plan - Remote Headworks and Cross-Harbor Tunnels
Existing and Recommended Projects**

Last revision 8/6/13

FY14 CIP Notes

Project Types

FY14 CIP Notes

new project, not previously in CIP

Line No	Priority	Project	Project Type	FY14 CIP Project No.	FY14 CIP Contract No.	Project Duration	Cost (\$1000)	Schedule	5 years				Total Cost (\$1000)
									FY14-18	FY19-23	FY24-33	FY34-53	
REMOTE HEADWORKS AND CROSS-HARBOR TUNNELS													
8.01	1	Chelsea Creek Headworks Upgrade - Design/Construction Admin/REL	AP	145	10387_6802 10465_7206	6 years	7,072	ongoing-FY19	6,788	284			7,072
8.02	2	Chelsea Creek Headworks Upgrade - Construction	AP	145	10445_7161	5 years	52,050	FY15-19	39,275	12,775			52,050
8.03	1	Ward Street Headworks and Columbus Park Headworks Upgrade - Design/Construction Admin/REL	AP	145	10510_7429	7 years	9,747	FY16-22	3,825	5,922			9,747
8.04	2	Ward Street Headworks and Columbus Park Headworks Upgrade - Construction	AP	145	10511_7430	4 years	95,330	FY19-22		95,330			95,330
8.05	2	Nut Island Electrical and Grit/Screenings Conveyance - Design/Construction	AP	145	10477_7312 10478_7313	3 years	8,518	ongoing-FY16	8,518				8,518
8.06	3	Nut Island Mechanical and Electrical Replacements	AP	145	10460_7219	4 years	3,000	FY17-20	1,750	1,250			3,000
8.07	3	Nut Island Fire Pump Building - Study	AP	145	10459_7218	3 years	600	FY14-16	600				600
8.08	3	Nut Island Odor Control System - Evaluation & Design	Opti	132	10492_7365	3 years	1,000	FY15-17	1,000				1,000
8.09	2	Headworks Effluent Shaft - Study	Plan	145	10463_7237	2 years	500	FY16-17	500				500
8.10	2	Cross-Harbor Tunnel Inspection and Shaft Repairs - Planning/Design/Construction	Plan/AP	146	10454_7199	3 years	5,000	FY19-21		5,000			5,000
SUBTOTAL - Existing - Headworks and Tunnels									62,256	120,561	0	0	182,817
8.11	3	Long-Term Wastewater Facility Asset Protection (for Remote Headworks) \$1M per year for FY24-53	AP	new		Annual	30,000	FY24-53		10,000	20,000		30,000
8.12	4	Nut Island Pier Rehabilitation Plan/Design/Construction	AP	new		2 years	500	FY20-21		500			500
8.13	3	Nut Island HW Future Equipment Replacement	AP	new		10 years	30,000	FY29-38		15,000	15,000		30,000
8.14	4	Cross-Harbor Tunnel Inspection/Condition Assessment and Cleaning/Rehab	Plan/AP	new		5 years	50,000	FY46-50			50,000		50,000
SUBTOTAL - Recommended - Headworks and Tunnels									0	500	25,000	85,000	110,500
SUBTOTAL - Existing and Recommended - Headworks and Tunnels									62,256	121,061	25,000	85,000	293,317

CHAPTER 9

COLLECTION SYSTEM SEWERS

9.01 Chapter Summary

MWRA's wastewater collection system is a complex network of conduits and facilities that is strongly influenced by seasonal and wet weather conditions. The system average daily flow is approximately 360 mgd, minimum dry weather flow is approximately 260 mgd, and peak wet weather capacity to the Deer Island Treatment Plant (DITP) is 1,270 mgd with additional system capacity available at combined sewer overflow (CSO) outfalls. The MWRA collection system includes a network of 274 miles of sewer pipelines (19 miles of cross-harbor tunnels, 226 miles of gravity sewers, 18 miles of force mains, 7 miles of siphons, and 4 miles of CSO and emergency outfalls); 13 pump stations; one screening facility; six CSO treatment/storage facilities; and four remote headworks facilities.

In this Chapter, MWRA's collection system sewers (interceptors, gravity tunnels, force mains, siphons, CSO and emergency outfalls, manholes, and other sewer structures) are detailed. The primary function of MWRA's collection system sewers is to transport wastewater received from its 43 sewer member communities (through over 1800 community connection points) to MWRA headworks facilities. Sewer force mains are the discharge piping from sewer pump stations. Sewer siphons, more appropriately know as inverted siphons and also called depressed sewers, are gravity sewers designed to dip under an obstruction, such as a river, subway, conduit, etc. CSO and emergency outfalls are the discharge piping that release excess flow to receiving waters, generally during large rainfall events or other emergencies. MWRA's goal is to operate and maintain the wastewater collection system to provide uninterrupted service in a safe, cost-effective and environmentally sound manner.

The replacement asset value of the collection system sewer pipelines is \$1,900 million (28% of wastewater system asset value). See detail on Wastewater Infrastructure Replacement Asset Value in Section 3.07. The facilities are detailed within the Chapter Section noted below:

- 9.03 Gravity Sewers;
- 9.04 Gravity Sewer Asset Protection and Interceptor Renewal Methodology;
- 9.05 Sewer System Capacity and Optimization Projects;
- 9.06 Gravity Sewer Manholes and Related Structures;
- 9.07 Siphons and Siphon Headhouse Structures;
- 9.08 Force Mains and Related Valves;
- 9.09 CSO and Nut Island Emergency Outfalls; and
- 9.10 SCADA and Wastewater Metering System.

The average age of the sewer system is about 65 years old. Approximately 30 percent of sewers are over 100 years old, another 31 percent are between 51 to 100 years old, and the remaining 39 percent are 50 years old or less. Overall, the collection system is in reasonably good condition, given its average age. Based on internal TV inspection ratings for gravity sewer pipe, approximately 52 miles (23 percent) are in very good condition (A-rated), 139 miles (61 percent) are in fair to good condition with some damage (B-rated), 18 miles (8 percent) of interceptors are

severely damaged (C-rated), and an additional 18 miles (8 percent) of gravity sewer, mostly newly constructed interceptors, were unrated at the time of the analysis. The gravity sewer inspection ratings have not been used for force mains, siphons, or outfalls; however, based on available data, these also appear to be in reasonably good condition.

The majority of MWRA's past CIP funds spent on sewer interceptor projects have constructed new facilities, some combination of sewer replacement and relief sewer construction, that were a priority to solve sewer capacity issues. Currently, the most critical need for the sewer system is rehabilitation construction that will address long-term sewer asset protection. As part of the initial 2006 Wastewater System Master Plan process, staff developed an interceptor renewal methodology to identify and prioritize the planning/design/construction process for sewer repair/rehabilitation projects. The prioritized list of interceptor renewal projects recommended in the 2006 Master Plan has been updated and is again recommended in the 2013 Master Plan. More than \$57.0 million in interceptor renewal/asset protection projects are programmed in the FY14 CIP (FY14-33) and \$82.0 million in interceptor renewal/asset protection projects are recommended for consideration in future CIPs (FY24-38). An additional \$75.0 million placeholder is recommended for future (long-term) interceptor renewal/asset protection projects during FY39-53. Other high priority collection system needs include a system-wide study to address hydrogen sulfide/odor problems, as well as, specific projects to rehabilitate pipelines with known hydrogen sulfide deterioration. The highest priority need for sewer structures is rehabilitation design/construction of siphon headhouse chambers due to physical defects and access issues as identified in a 1996 siphon structure needs assessment. Lower priority projects to be addressed in the long-term (FY19 and beyond) include asset protection projects for force mains, siphons, and outfalls, as well as, new facilities to increase capacity and optimize system performance.

For collection system sewers, periodic inspection, data management, and scheduled maintenance are key elements to minimize risk of sewer plugging or structural failure. A major uncertainty is the timing and intensity of large storm events resulting in peak wastewater flows that stress the system's hydraulic capacity. Collection system operations, particularly in preparation of and during storm events, are intended to optimize system performance and minimize potential CSOs and SSOs. Key decision making to minimize risks includes where/how often to perform preventative maintenance activities and the cost/benefit analysis of when to rehabilitate aging sewer pipelines. Planned and scheduled sewer rehabilitation/replacement projects are generally more cost-effective than emergency repairs that need to be made if the system is allowed to run to failure.

For collection system sewers, \$375.218 million in projects are identified in the 40 year master plan timeframe (FY14-53). Twenty-three projects (\$92.818 million) are programmed in the FY14 CIP. Twenty-two additional projects (\$282.4 million) are recommended for consideration in future CIPs. Section 9.11 – Summary of Existing and Recommended Capital Projects includes a consolidated list of all projects recommended in this Chapter.

Near-term (FY14-18):

- \$22.249 million is programmed in the FY14 CIP:
 - \$4.6 million to begin design and construction of Interceptor Renewal/Asset Protection Project #1 for Sewer Sections 240, 241, and 242 in Dorchester;
 - \$565,000 to begin design and construction of Interceptor Renewal/Asset Protection Project #2 for Sewer Sections 163 and 164 in Brighton;
 - \$3.539 million to complete rehabilitation construction of Sewer Sections 186 and 4;
 - \$5.058 million to begin rehabilitation design and construction for Sewer Sections 4, 5, and 6 on the North Metropolitan Sewer in Winthrop;
 - \$1.289 million to continue portions of the Braintree/Weymouth Relief Facilities including improvements design, construction inspection, land acquisition, and wetlands replication;
 - \$75,000 to begin portions of the Braintree/Weymouth Relief Facilities Project including Mill Cove Siphon Sluice Gate design and construction;
 - \$259,000 to complete the North System Hydraulic Capacity Study under Wastewater Process Optimization;
 - \$2.093 million to complete the North System Hydraulic Flood Engineering Analysis under Wastewater Process Optimization;
 - \$40,000 to begin the Somerville/Medford Branch Sewer study, design, and construction under Wastewater Process Optimization;
 - \$150,000 to develop a plan for relief of the Cambridge Branch Sewer/DeLauri Pump Station Siphon as recommended in the Wastewater Process Optimization project; and,
 - \$4.581 million to begin phase 1 of Siphon Structure Rehabilitation design and construction.

- \$7.4 million in needs is identified for FY14-18 and recommended for consideration in future CIPs:
 - \$400,000 for the Winthrop Terminal Facility System Hydraulic Capacity Study under Wastewater Process Optimization;
 - \$1.0 million for the Charles River System Hydraulic Capacity Study under Wastewater Process Optimization;
 - \$1.0 million for the first 5 years of the Annual Manhole Rehabilitation Program with a target of \$200,000 per year (100 manholes per year at \$2,000 each); and,
 - \$5.0 million for the first 5 years of the Force Main Asset Protection Project.

Mid-term (FY19-23):

- \$51.829 million is programmed in the FY14 CIP:
 - \$200,000 to complete design and construction of Interceptor Renewal/Asset Protection Project #1 for Sewer Sections 240, 241, and 242 in Dorchester;
 - \$11.051 million to complete design and construction of Interceptor Renewal/Asset Protection Project #2 for Sewer Sections 163 and 164 in Brighton;
 - \$5.0 million for planning, design, and construction of Interceptor Renewal/Asset Protection Project #3 for Sewer Sections 26 and 27 in Cambridge and Somerville;
 - \$1.3 million for planning, design, and construction of a Malden/Melrose Area Hydraulic and Structural Study and a Portion of Interceptor Renewal/Asset Protection Project #7 in Malden/Melrose;

- \$7.942 million to complete rehabilitation design and construction for Sewer Sections 4, 5, and 6 on the North Metropolitan Sewer in Winthrop;
 - \$2.759 million to complete design/construction of biofilters for the FES/FERS system to reduce corrosion and control odors;
 - \$8.5 million for design/construction of rehabilitation of the FES Tunnel for corrosion and odor control;
 - \$1.0 million for a System-wide Corrosion and Odor Control Study;
 - \$1.0 million for future internal inspection of the West Roxbury Tunnel;
 - \$3.766 million to complete portions of the Braintree/Weymouth Relief Facilities including improvements design, construction inspection, land acquisition, and wetlands replication;
 - \$675,000 to complete portions of the Braintree/Weymouth Relief Facilities Project including Mill Cove Siphon Sluice Gate design and construction;
 - \$750,000 for a study of relief alternatives for the Randolph Trunk Sewer;
 - \$4.651 million to continue the North System Hydraulic Flood Engineering Analysis under Wastewater Process Optimization;
 - \$458,000 to begin the System Relief and Contingency Planning Project;
 - \$1.194 million to complete the Somerville/Medford Branch Sewer study, design, and construction under Wastewater Process Optimization;
 - \$83,000 to complete phase 1 of Siphon Structure Rehabilitation design and construction; and,
 - \$1.5 million for structural improvements to Outfall MWR023 (outfall to the Charles River) located in the Fenway section of Boston under South System Relief.
- \$20.0 million in needs is identified for FY19-23 and recommended for consideration in future CIPs:
 - \$1.0 million for the South System Hydraulic Capacity Study under Wastewater Process Optimization;
 - \$1.0 million for the second 5 years of the Annual Manhole Rehabilitation Program with a target of \$200,000 per year (100 manholes per year at \$2,000 each);
 - \$1.0 million for Woburn Sand Catcher Upgrade construction;
 - \$8.0 million for Sliplining design and construction of Sewer Section 652, the Fore River Siphon in the Braintree/Weymouth system;
 - \$4.0 million for phase 2 of Siphon Structure Rehabilitation design and construction; and,
 - \$5.0 million for the second 5 years of the Force Main Asset Protection Project.

Long-term (FY24-33 and FY34-53):

- \$18.74 million is programmed in the FY14 CIP:
 - \$3.0 million for planning, design, and construction of Interceptor Renewal/Asset Protection Project #4 for Sewer Sections 23 and 24 in Everett;
 - \$4.0 million for planning, design, and construction of Interceptor Renewal/Asset Protection Project #5 for Sewer Sections 607, 609, and 610 in Milton;
 - \$11.0 million for planning, design, and construction of Interceptor Renewal/Asset Protection Project #6 for Sewer Sections 12, 14, 15, and 62 in Chelsea;
 - \$698,000 to complete the North System Hydraulic Flood Engineering Analysis under Wastewater Process Optimization; and,

- \$42,000 to complete the System Relief and Contingency Planning Project.
- \$255.0 million in needs is identified for FY24-33 and FY34-53 and recommended for consideration in future CIPs:
 - \$12.0 million to complete planning, design, and construction of Interceptor Renewal/Asset Protection Project #7 in Malden/Melrose;
 - \$10.0 million for planning, design, and construction of Interceptor Renewal/Asset Protection Project #8 for Sewer Section 30 in Cambridge and Sewer Sections 31 and 32 in Charlestown;
 - \$12.0 million for planning, design, and construction of Interceptor Renewal/Asset Protection Project #9 for Sewer Sections 46, 47, 73, 74, 75, and 153 in Winchester, Woburn, and Stoneham;
 - \$30.0 million for planning, design, and construction of Interceptor Renewal/Asset Protection Project #10 for Sewer Sections 21, 52, 53, 78, 79, 111, 112, and 189 in Arlington and Medford;
 - \$15.0 million for planning, design, and construction of Interceptor Renewal/Asset Protection Project #11 for Sewer Sections 516, 521, 522, 523, and 524 in Dedham and Hyde Park;
 - \$3.0 million for planning, design, and construction of Interceptor Renewal/Asset Protection Project #12 for Sewer Section 618 in Norwood;
 - \$75.0 million as a placeholder for future long-term planning, design, and construction of Interceptor Renewal/Asset Protection Project #13 at \$5.0 million per year during FY39-53;
 - \$30.0 million for Wellesley Extension Replacement Sewer rehabilitation design/construction project;
 - \$15.0 million for Neponset Valley Sewer Capacity Relief Project planning, design, and construction;
 - \$1.0 million for Ashland Extension Sewer Capacity Relief Project planning and design;
 - \$6.0 million for continuation of the Annual Manhole Rehabilitation Program for an additional 30 years with a target of \$200,000 per year (100 manholes per year at \$2,000 each);
 - \$25.0 million for design and construction for upgrade/relief of the Cambridge Branch Sewer/DeLauri Pump Station Siphon as recommended in the Wastewater Process Optimization project;
 - \$4.0 million for phase 3 of Siphon Structure Rehabilitation design and construction;
 - \$5.0 million for the Siphon Asset Protection Project;
 - \$10.0 million for the last 10 years of the Force Main Asset Protection Project; and,
 - \$2.0 million for the Outfall Asset Protection Project.

9.02 Overview of the Collection System

The MWRA's regional collection system receives wastewater flow from 43 member communities, including Boston and the surrounding metropolitan region, serving a population of about 2.1 million in a service area of about 518 square miles. About 95 percent of the service area is sewered. The location of member communities and general layout of the collection system is shown on Figure 9-1. Each community owns and operates its local wastewater collection system. Approximately seven percent of the service area (36 square miles) contains combined sewers that are designed to receive both sanitary and storm water flow, including portions of Boston, Brookline, Cambridge, Chelsea, and Somerville. The remaining 93 percent of the collection system service area contains separated sanitary and storm water collection systems. All flow from the service area is conveyed to the DITP. The history and growth of the wastewater service area is presented in Chapter 3. The regional collection system encompasses about 274 miles of MWRA-owned sewers and over 5,200 miles of publicly-owned community sewers connected to MWRA interceptors at over 1,800 connections. There are also over 5,000 miles of private sewer service laterals that connect building plumbing to the community-owned sewers. Additional information on community-owned collection systems is provided in Chapter 15.

The different types of sewer pipelines that comprise the MWRA collection system are listed in Table 9-1 below and shown on Figure 9-2.

TABLE 9-1
Sewers by Type

Sewer Type	Miles	Percent
Gravity Sewers	226	82%
Cross-Harbor Tunnels	19	7%
Force Mains	18	7%
Siphons	7	3%
CSO and Emergency Outfalls	4	1%
TOTAL	274	100%

The MWRA collection system sewers range in size from 8-inch to greater than 10-feet in diameter. The sewer system has been constructed of a variety of materials and has been built out and sections replaced/rehabilitated over the last 135 years. General representations of the MWRA sewer system by size, material, and year constructed are presented in Figures 9-3, 9-4, and 9-5, respectively.

Management of collection system sewers is the responsibility of the Wastewater Operations and Maintenance Department, which is a subset of the Operations Division under the oversight of the Chief Operating Officer and one of the Deputy Chief Operating Officers. Two key supervisory staff reporting to the Director, Wastewater Operations and Maintenance are the Manager of Operation and Manager of Maintenance.

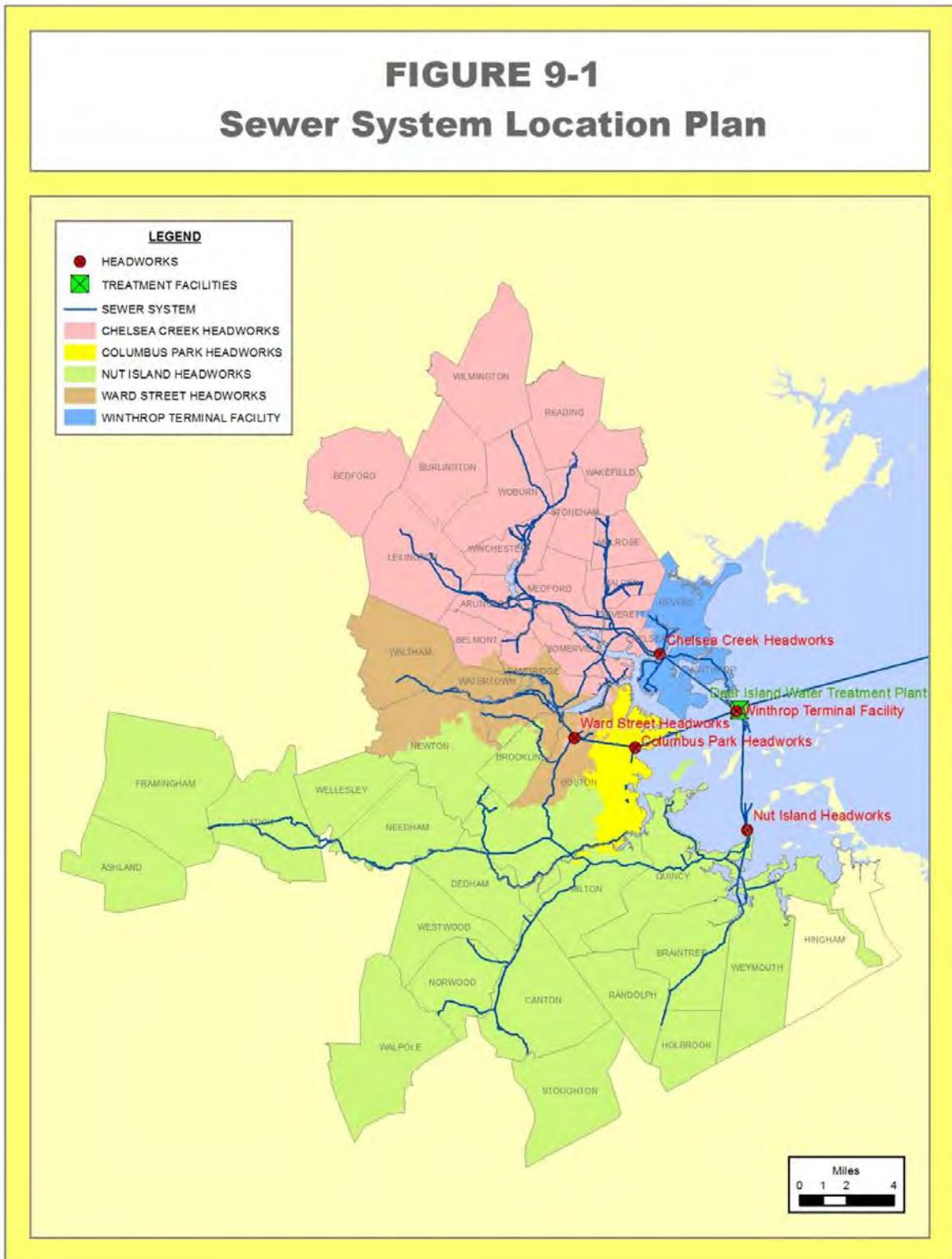
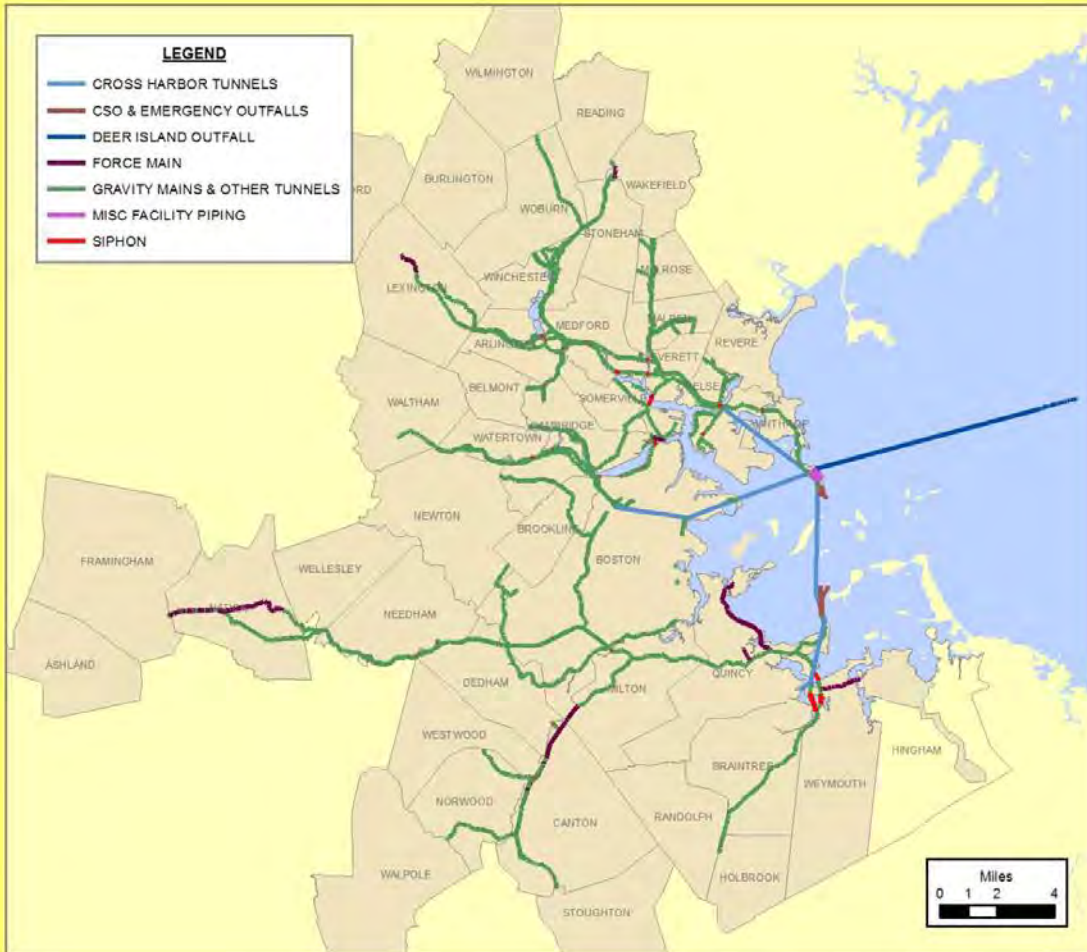

FIGURE 9-2 Sewers By Type

HIGHLIGHTS

<i>Type</i>	<i>Miles</i>	<i>Percentage</i>
GRAVITY MAINS & OTHER TUNNELS	226	82%
CROSS HARBOR TUNNELS	19	7%
FORCE MAIN	18	7%
SIPHON	7	3%
CSO & EMERGENCY OUTFALLS	4	1%
TOTAL	274	100%

The 274 miles of sewer and resulting data exclude the Deer Island Outfall (9.4 miles) and Misc Facility Piping (3.6 miles).



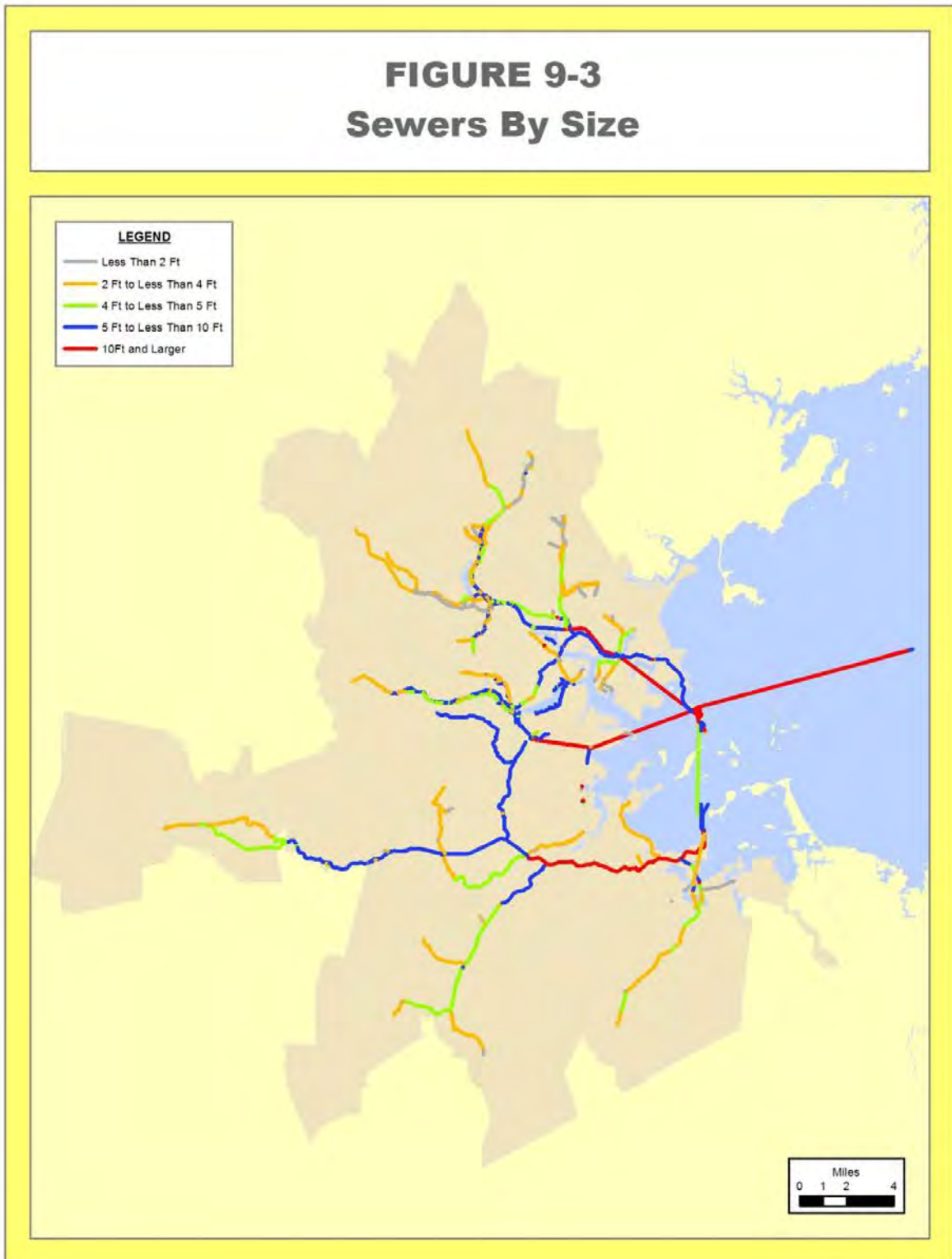

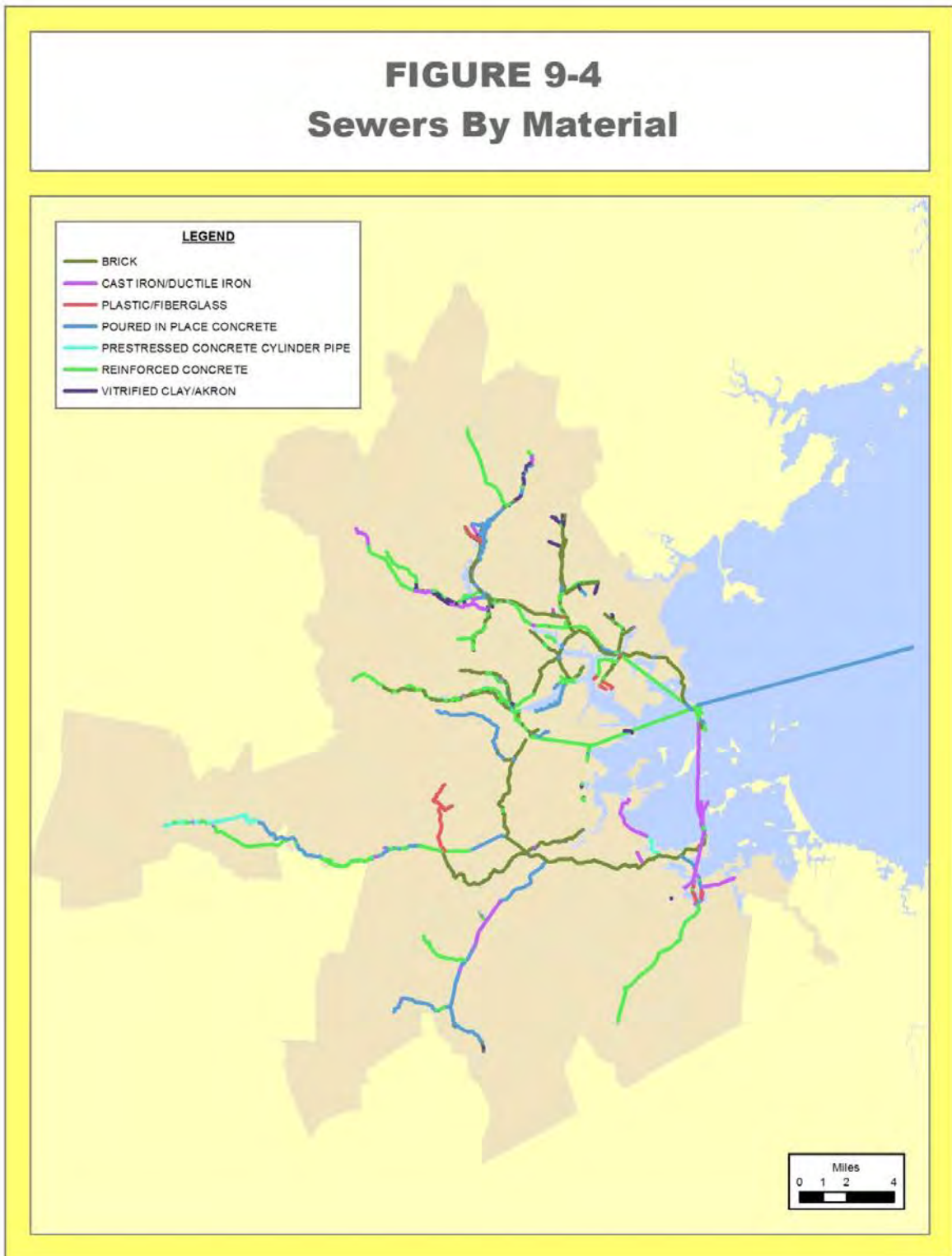

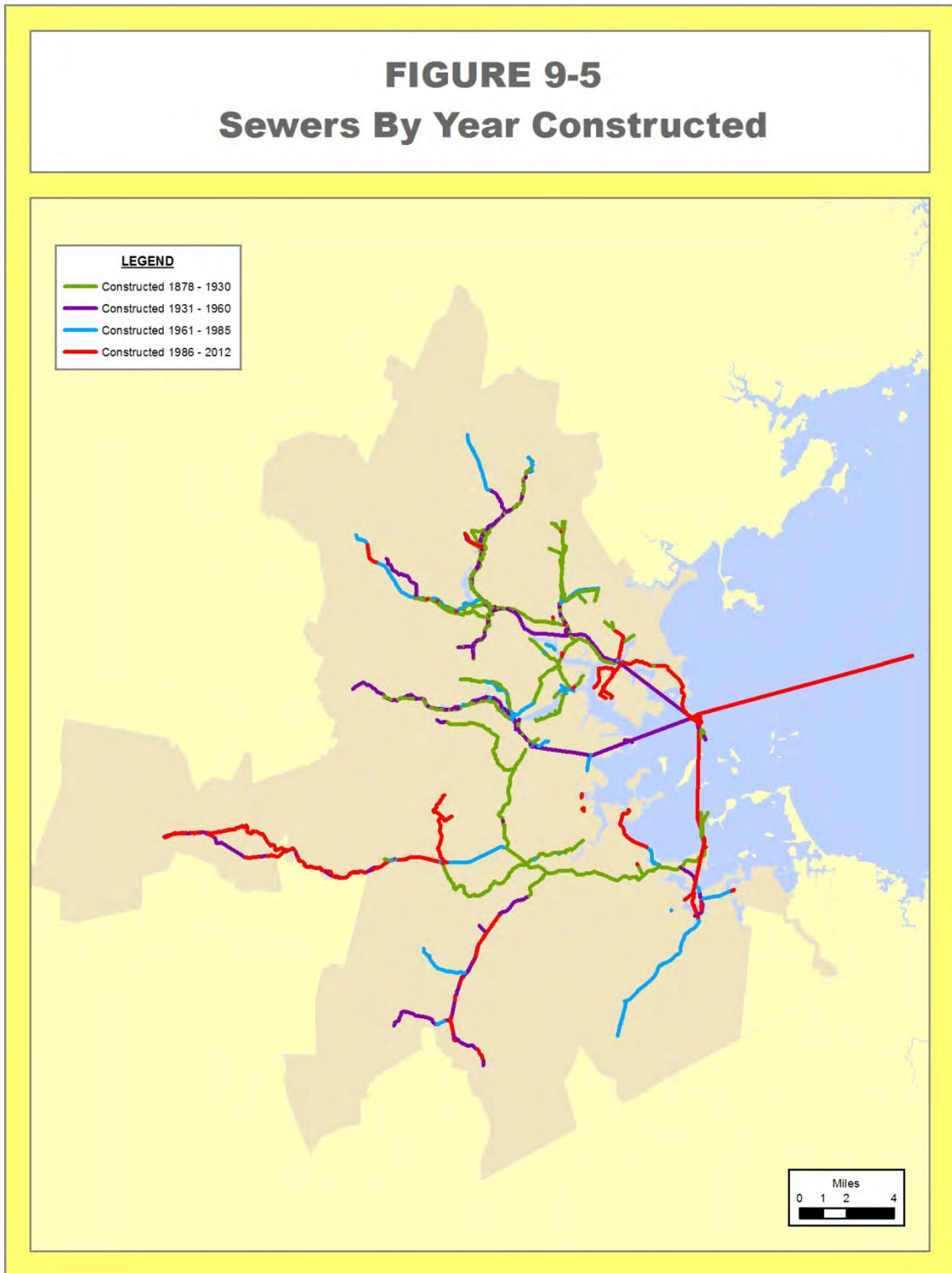

Operation and Maintenance: A total of about 23 employees are responsible for the operation and maintenance of MWRA collection system sewers. Operation and maintenance activities are based on industry best practices and designed to provide uninterrupted service in a safe, cost-effective and environmentally sound manner, as well as satisfy applicable regulatory requirements. Operation and maintenance practices are detailed in MWRA's Collection System Operation and Maintenance Manual. The Technical Inspection Unit is responsible for all sewer inspections and reporting. Based on pipeline inspection and wastewater flow data review, maintenance activities are scheduled by Work Coordination through the MWRA's MAXIMO maintenance work order system.

MWRA has made significant technological investments to enhance operation and maintenance including: Geographic Information System (GIS) mapping, Sewerage Analysis and Maintenance System (SAMS) attribute data management, Infoworks hydraulic modeling, and internal sewer inspection utilizing closed-circuit television (CCTV) and sonar technologies. MWRA's extensive inspection program information is used to schedule preventative maintenance, identify structural ratings, identify infiltration/inflow sources, and help define rehabilitation projects. During each inspection, a log is maintained detailing all pipeline parameters, service connections, and defects observed. A permanent record of each inspection log is maintained in an electronic database and can be used to generate detailed reports.

MWRA In-House Tasks: There are four in-house tasks related to the collection system sewers recommended to be completed by MWRA staff:

- There are 12 C-rated interceptor renewal projects recommended (see Section 9.04) to be rehabilitated over an extended period (up to 40 years) due to budget and staffing considerations. It is recommended that MWRA staff periodically review updated sewer TV inspection information of all C-rated pipe and adjust the priority of projects planned in the CIP to ensure the most critical sewer sections receive the highest priority ranking. In addition, staff should conduct future iterations of the interceptor renewal methodology (recommended to be performed every 5 years) as updated sewer inspection rating information is incorporated into the electronic database. The analysis presented in this Chapter was initially developed for the 2006 Wastewater System Master Plan. A review and update of the priority ranking of C-rated sections was being developed by MWRA's Wastewater Engineering Department during FY14. Future iterations should incorporate the updated sewer structural rating system being developed. Use of the most current system physical information will help ensure that the most critical projects are assigned the highest priority ranking.
- Staff should implement an in-house planning and design task to develop plans and specifications for the recommended construction project to rehabilitate the Woburn Sandcatcher (see Section 9.06). The Woburn Sandcatcher project is intended to optimize flow through the division structure, provide appropriate access for system maintenance, and improve debris removal. Use of as-needed consultants may be appropriate.

- Staff should conduct an evaluation of MWRA's sewer force mains and air valves (see Section 9.08). The task should evaluate age and material related factors and may draw from experience gained from previous sewer force main repairs and work on water main piping. This analysis may help predict force mains that may be susceptible to failure.
- Staff should update the 2001 Collection System Operation and Maintenance Manual and incorporate appropriate sections from EPA's Capacity, Management, Operation and Maintenance (CMOM) Guidance.

9.03 Gravity Sewers

There are about 226 miles of gravity sewers in the MWRA collection system, accounting for about 82 percent of wastewater collection system pipelines. Gravity sewers include interceptors built using open-cut construction methods, as well as sewers built by tunneling. The major difference between these types of gravity sewers is that open-cut construction allows for placement of sewer manholes, generally every ± 300 feet. Sewer manholes provide access for operation and maintenance activities. Access to tunnel sections is dependent on individual site conditions. For example, MWRA's West Roxbury Tunnel (Section 637/638) is a 2.8 mile long gravity tunnel with only three access shafts that requires special operation and maintenance considerations. Key information on MWRA Interceptors is provided in Table 9-2.

Sewer age and construction material are key components that determine the useful life of sewers. The average useful life commonly cited in industry literature for sewer pipes is 100 years. This excludes tunnels and outfalls, that are generally expected to have a longer useful life. The average age of the MWRA sewer system is about 65 years old. Approximately 30 percent of sewers are over 100 years old, another 31 percent are between 51 to 100 years old, and the remaining 39 percent are 50 years old or less. Figure 9-6 provides a more detailed age classification of the sewer system. The sewer system is constructed of a variety of pipe materials as detailed in Figure 9-7. The three most prevalent pipe materials are reinforced concrete (32 percent), brick (26 percent), and poured-in-place concrete (22 percent).

TABLE 9-2
MWRA Interceptors

Name	Section #	Community	Material	Approximate Diameter (ft)	Year Built	Length (ft)
Alewife Brook Conduit	176-179	Arlington, Belmont, Cambridge, Medford & Somerville	BR, RC, PIPC	3-10	1948, 1950	18,423
Belmont Extension Sewer, (Metropolitan Sewer)	063	Cambridge	BR, CI/DI	2-3	1904	6,361
Belmont Relief Sewer	081	Belmont/Cambridge	CI, RC	1-3	1927	3,533
Boston Main Drain Relief Sewer	201	Roxbury	PIPC	7	1961	4,821
Boston Marginal Conduit	222	Boston Main, Roxbury	CI/DI, RC, PIPC	5-14	1910	11,559
Braintree-Weymouth Interceptor	622-625	Braintree, Quincy & Weymouth	CI, HDPE, PIPC, RC	1-5	1933-1934, 1982, 2002	15,591
Brighton Branch Sewer, (Extension of High Level Sewer)	580-587	Brighton, Brookline, Newton, & West Roxbury	BR, CI, PIPC	5-7	1907-1909, 1933	26,762
Bryant St Sewer	195, 196	Malden	RC, VC	1-2	1967	2,627
Cambridge Branch Sewer, (Metropolitan Sewer)	023-028, 154	Cambridge, Charlestown, Everett, & Somerville	BR, PIPC	4-7	1892-1895	16,926
Cambridge Marginal Conduit	229	Cambridge	CI, PIPC	4-8	1910	2,361
Castle Island & Conley Terminal Sewer	252	South Boston	VC	1	1960	2,258
Charles River Marginal Conduit	198-200, 215-217	Boston Main, Cambridge, Charlestown	DI, RC	2-10	1973-1974, 1979	8,280
Charles River Valley Sewer	162-165, 190-192, 202-203	Brighton, Brookline, Newton, Roxbury, & Watertown	BR, CI, PIPC, RC	3-9	1891-1892, 1906, 1948, 1954, 1963	44,788
Charlestown Branch Sewer, (Metropolitan Sewer)	031-032	Charlestown	BR, RC	2-3	1895, 1989	10,446
Chelsea Branch Relief Sewer	250	Chelsea	BR, RC	4-6	2001	7,691
Chelsea Branch Sewer, (Metropolitan Sewer)	056-057	Chelsea, Everett	BR, PIPC, RC	2-4	1901, 1999-2001	8,315
Clinton Interceptor	402	Clinton	BR, VC/VTC	2-3	2001	5,131
Cummingsville Branch Relief Sewer	086	Winchester, Woburn	RC, PIPC	3	1952	4,979
Cummingsville Branch Replacement Sewer	248	Winchester, Woburn	PL/FG	2-4	2006	4,992
Cummingsville Branch Sewer, (Metropolitan Sewer)	047	Winchester, Woburn	VC	1-2	1894, 1904, 2006	4,516
Dedham Branch Sewer	532	Canton/Dedham	CI, RC	1-2	1950	2,363
Dorchester Intercepting Sewer	240-242	Dorchester, Milton	BR, CI, PIPC, VTC	1-4	1895-1897	6,784
East Boston Branch Sewer, (Metropolitan Sewer)	036-038, 206-208, 255-256	East Boston	BR, CI, DI, HDPE, PIPC, PVC, RC, VC, VTC	1-6	1894, 2005, 2010	24,716
Edgeworth Branch Sewer, (Metropolitan Sewer)	020	Malden, Medford	BR, CI	2-3	1893, 1987	1,601
Everett Branch Sewer, (Metropolitan Sewer)	055	Malden	PIPC	1	1898	1,550
Extension to Everett in Broadway	066	Malden	VC	1-2	1911	2,625
Framingham Trunk Interceptor, Framingham Extension Sewer	632, 634, 657	Dover, Framingham & Natick	RC, PIPC	2-5	1954-1956, 1998, 2002	30,887
Framingham Extension Relief Sewer	678	Dover, Natick & Wellesley	PIPC	2-5	1999	10,417
High Level Sewer	545-575	Hyde Park, Milton, Quincy, Roxbury & West Roxbury	BR, CI, PIPC, RC	3-15	1900-1904, 1958, 2000	80,089
Holbrook Extension Sewer	656	Braintree, Holbrook, & Randolph	RC	2-4	1973	8,261
Lexington Branch Sewer, (Metropolitan Sewer)	053	Arlington	CI, VC	1-2	1899	4,515
Main Street Branch Sewer, (Metropolitan Sewer)	031	Charlestown	CI/DI, PIPC	1-2	1895	656

TABLE 9-2 (continued)
MWRA Interceptors

Name	Section #	Community	Material	Approximate Diameter (ft)	Year Built	Length (ft)
Malden Extension Sewer, (Metropolitan Sewer)	064	Malden	BR, CI, PIPC, RC	3-6	1907	3,148
Malden Relief Sewer	087, 197	Everett, Malden	BR, RC	4-5	1959, 1969	8,500
Malden Relief Sewer, (Saugus Branch Brook Flood Control Project)	095	Malden	BR, PIPC, RC	2-4	1969	8,988
Melrose Highlands Trunk Sewer	049	Melrose	BR	1-2	1896	3,894
Metropolitan Sewer	010, 012, 014-017, 020-022, 029, 030, 040-046, 048, 052, 054, 058-060, 065, 150, 155, 156, 175, 187-189, 227, 228, 654	Arlington, Braintree, Cambridge, Chelsea, Dorchester, East Boston, Everett, Malden, Medford, Melrose, Somerville, South Boston, Stoneham, Winchester & Woburn	BR, CI, DI, PIPC, RC, VC, VTC	1-9	1891-2001	154,494
Millbrook Valley Sewer	077-080, 082-085	Arlington, Lexington, & Medford	BR, CI, PIPC, RC, VC, VTC	1-4	1899, 1925-1934, 1948, 1953, 1967, 2005	34,564
Millbrook Valley Relief Sewer	092-093, 151-152, 172-173	Arlington, Lexington, & Medford	DI, RC	1-6	1965-1967, 1972, 2005	39,754
Mystic Valley Sewer	153, 160	Medford, Winchester, & Woburn	BR, CI, PIPC, VC	1-2	1878-1879, 1950	14,530
Neponset Valley Sewer	243-246, 515-525	Dedham, Dorchester, Hyde Park & Milton	BR, CI, DI, PIPC, RC, VC	1-5	1896-1897, 1963, 1972	36,628
Neponset Valley Relief Sewer	531	Hyde Park, Milton	BR, CI, PIPC	3-6	1935	479
New Mystic Valley Sewer	067-072, 109-110	Medford, Winchester, & Woburn	BR, CI, PIPC, VC	2-6	1913-1914, 1924, 1929, 1937	31,924
New Neponset Valley Sewer	607-615, 619	Canton, Milton	CI, PL, PIPC	1-6	1930-1932, 1992	45,941
New Neponset Valley Relief Sewer	671	Canton	PIPC	5	1992	5,514
New Neponset Valley Sewer Replacement	614	Canton	RC	5	1964	1,076
North Charles Relief Sewer	181-184	Cambridge	PIPC, RC, VC	2-7	1968, 1971-1972, 1976	18,397
North Charles Relief Sewer, Charles River Sewer Crossing	180	Brighton, Cambridge	RC	3-9	1965, 1968	2,857
North Metropolitan Trunk Sewer	003-006, 008-009, 186	East Boston, Winthrop	BR, PIPC, STL	4-15	1894, 1960, 1989, 1993, 1997	24,704
North Metropolitan Trunk Sewer, Belle Isle Inlet	007	East Boston, Winthrop	BR, PIPC	5-14	1895, 1997	1,320
North Metro Relief Sewer	102-103, 105-108, 111-114, 158, 168-169, 193-194	Chelsea, Everett, Medford, Stoneham, Winchester & Woburn	BR, CI, PIPC, RC, VC	3-13	1936-1973, 1950, 1965-1968	71,307
North Weymouth Relief Interceptor	639	Weymouth	CCFP, RC	5	2004	1,655
Old High Level Sewer	247	Roxbury	BR	7	1903	445
Randolph Trunk Sewer	626-628, 655	Braintree, Randolph, & Weymouth	RC	1-4	1958	27,016
Reading Extension Sewer	073-075	Stoneham, Wakefield, & Woburn	CI, RC, VC	1-2	1919, 1921	12,205
Reading Extension Relief Sewer	204-205	Stoneham, Wakefield	DI, RC, PIPC	2-3	1921, 1984	6,393

TABLE 9-2 (continued)
MWRA Interceptors

Name	Section #	Community	Material	Approximate Diameter (ft)	Year Built	Length (ft)
Revere Extension Sewer	159	Chelsea, Revere	VC, VTC	1	1914	1,031
Revere Extension Sewer, (Metropolitan Sewer)	061, 062	Chelsea, Revere	BR, CI	3-5	1904, 2001	7,411
Somerville Marginal Conduit	230	Somerville	RC	7	1971	2,522
Somerville-Medford Branch Sewer, (Metropolitan Sewer)	035	Charlestown, Medford & Somerville	BR, RC, VC	2-4	1895-1896	8,803
South Charles Relief Sewer	001-002, 212, 218- 220	Brighton, Brookline, Cambridge, Newton, Roxbury, Waltham, & Watertown	BR, CI, PIPC, RC	2-13	1892, 1903, 1954-1958, 1967	51,194
Stoneham Branch Sewer, (Metropolitan Sewer)	051	Melrose	RC, VC	1	1897, 2001	4,025
Stoughton Extension Sewer	620-621	Canton, Stoughton	BR, PIPC, VC, VTC	2-3	1931-1932	6,558
Stoughton Extension Relief Sewer	670	Canton	BR, DI, PIPC	2-3	1992	9,746
Upper Neponset Valley Sewer	526, 529	Dedham, West Roxbury	BR, CI, PIPC, RC, VC	1-4	1897-1898	3,395
Upper Neponset Valley Replacement Sewer	685-688	Newton, West Roxbury	CCFP, PVC	1-4	2009	22,090
Wakefield Branch Sewer, (Metropolitan Sewer)	050	Melrose	BR, VC	1-2	1897	4,663
Walpole Extension Sewer	616-618	Canton, Norwood	CI, PIPC, RC	2-5	1931, 1957, 1964	16,151
Walpole Extension Relief Sewer	669	Canton, Norwood	BR, DI, PIPC, RC, VC	3-4	1992	7,160
Wellesley Extension Sewer	601	Dedham, Needham	CI, PIPC	1-3	1921	1,502
Wellesley Ext Sewer Replacement	664-668	Dedham, Dover, Needham, & Wellesley	DI, PIPC, RC	2-7	1989-1991	39,622
Wellesley Extension Relief Sewer	629-631, 638	Dedham, Dover, Needham, Wellesley, & West Roxbury	PIPC, RC	2-7	1951-1952, 1956, 1963, 2002	39,839
Westwood Interceptor, Westwood Extension Sewer	635-636	Canton, Norwood, & Westwood	RC	1-3	1961	12,937
Wilmington Trunk Sewer	088-090	Wilmington, Woburn	RC	3-4	1959, 1972, 1974	20,428

FIGURE 9-6 Sewer System Age

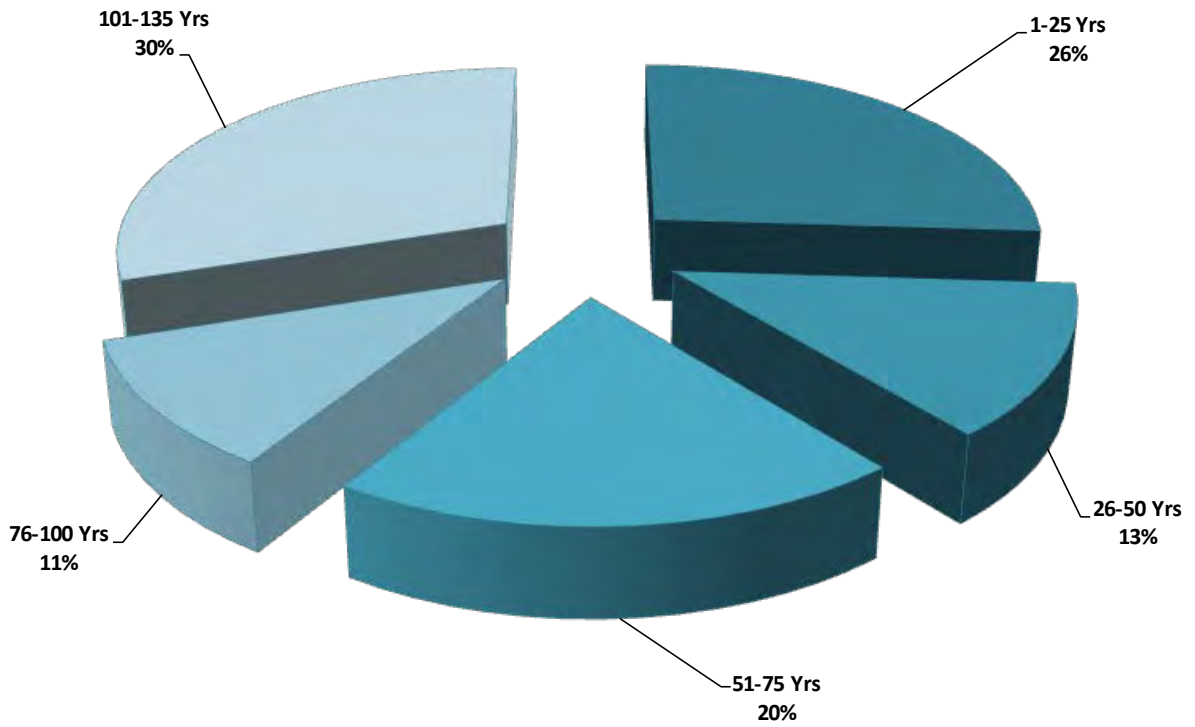
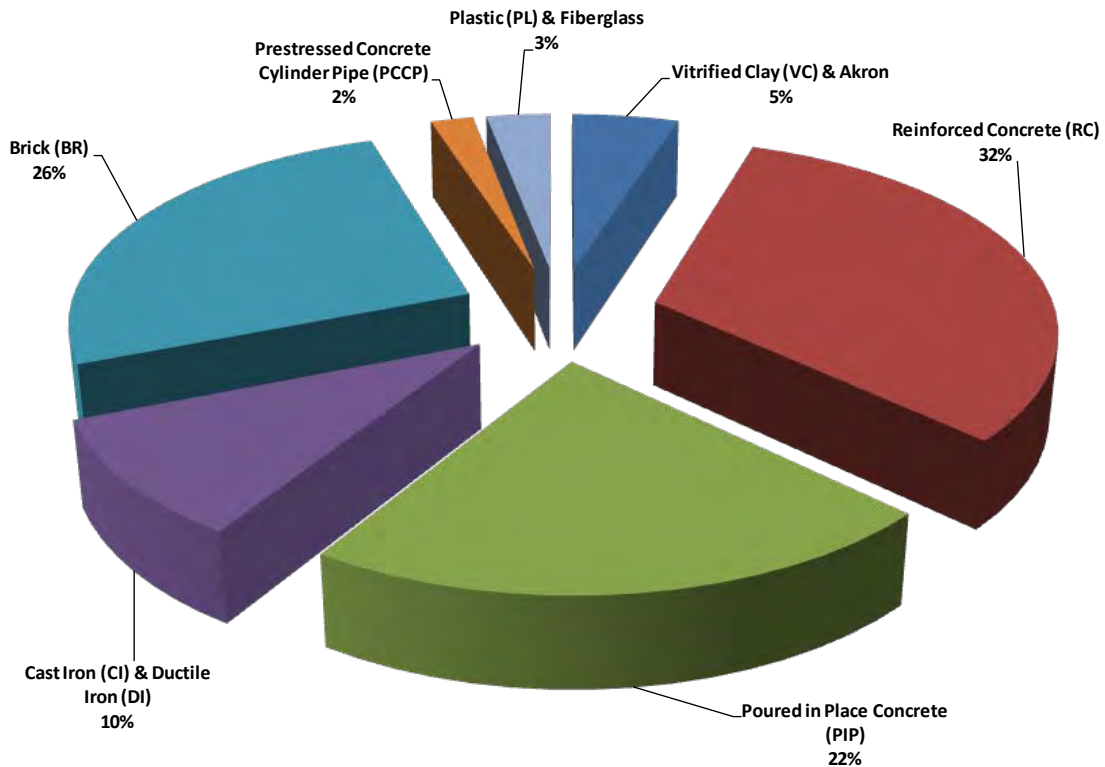
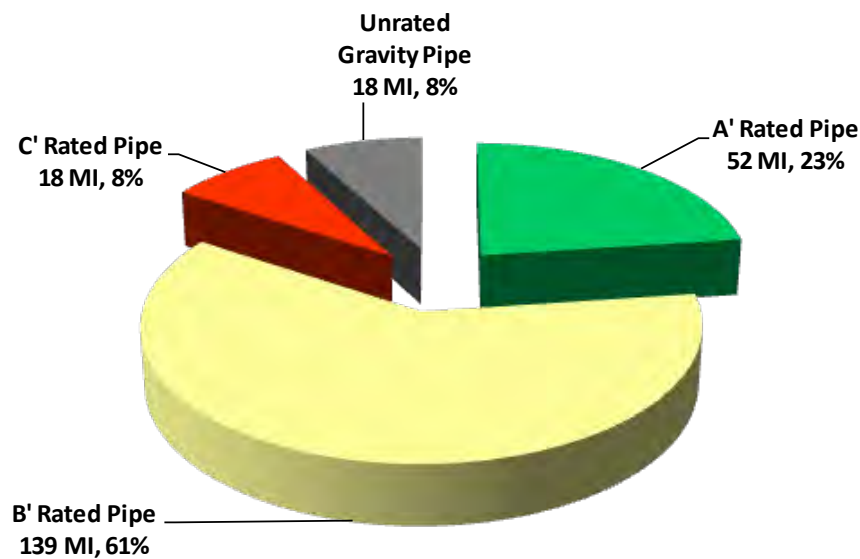

FIGURE 9-7 Pipe Material



Overall, MWRA's gravity sewer interceptors appear to be in reasonably good condition given their age. The Technical Inspection Unit is responsible for internal inspection and reporting for all MWRA-owned sewers. Each sewer pipe inspected has been classified based on the internal TV inspection A/B/C rating system for gravity sewer pipe. As reported in the 2006 Wastewater System Master Plan, approximately 52 miles (23 percent) were in very good condition (A-rated), 139 miles (61 percent) were in fair to good condition with some structural damage (B-rated), 18 miles (8 percent) were severely damaged and in poor condition (C-rated), and 18 miles (8 percent) were newly constructed interceptors that were not yet rated at the time of the analysis. Figure 9-8 provides the system breakdown for gravity sewer inspection A/B/C condition ratings as of the 2006 Master Plan. Photos on the next page show the Technical Inspection Unit equipment and some examples of C-rated sewer pipe in need of repair or replacement. As of July 2013, the Technical Inspection Unit, in collaboration with MWRA's Management Information Systems (MIS) Department, is in the process of upgrading the internal sewer inspection software and associated processes for uploading/downloading sewer attribute data and current inspection information. As part of this upgrade, the current CCTV inspection rating system is being reworked from the historic A/B/C rating system to a 1 (best) through 5 (worst) rating system. An expected benefit to this new rating system is to remove the subjectivity inherent to rating pipes under the current process. The new system will assign a value to each defect identified on every sewer segment being inspected and total up at the end of the inspection run. This consistency in data will provide MWRA's engineering staff with the best available data to use in prioritizing future interceptor renewal projects. The new sewer inspection rating system will be detailed in the next update of the Wastewater System Master Plan.

FIGURE 9-8 Gravity Sewer Condition Ratings





TV Inspection Crew



Inside of TV Inspection Truck

Examples of C-Rated Pipe



9.04 Gravity Sewer Interceptor Renewal and Asset Protection Methodology

While MWRA’s CIP has traditionally funded interceptor projects based on capacity and system optimization recommendations (see Section 9.05); during preparation of the 2006 Wastewater System Master Plan, staff developed a systematic planning process to address interceptor renewal/asset protection needs for MWRA’s gravity sewers. A project team with expertise in engineering, operations, planning, modeling, GIS and finance developed an objective interceptor renewal methodology for identifying and prioritizing projects to repair and/or rehabilitate sewer interceptor deficiencies, and develop cost estimates for phased CIP consideration. The in-house team assessed methodologies used by other utilities, entered MWRA condition assessment information into an electronic sewer database, and performed a statistical analysis of pipe attribute data versus sewer inspection condition ratings. Not surprisingly, staff found a correlation between MWRA pipes in poor structural condition (C rated) and pipe age and construction material. Nearly two-thirds (65 percent) of C-rated pipe was identified as over 100 years old and an additional 24 percent was identified as 50 to 100 years old. Figure 9-9 displays C-Rated Pipe by age. In terms of construction materials, 54 percent of the C-rated pipe was identified as constructed of brick. The analysis also indicated a higher than expected percentage of poured-in-place concrete that was 51 to 75 years old was in poor condition, perhaps reflecting a poorer quality of materials used during a certain timeframe. Figure 9-10 displays C-Rated Pipe by construction material.

FIGURE 9-9 C-Rated Pipe By Age

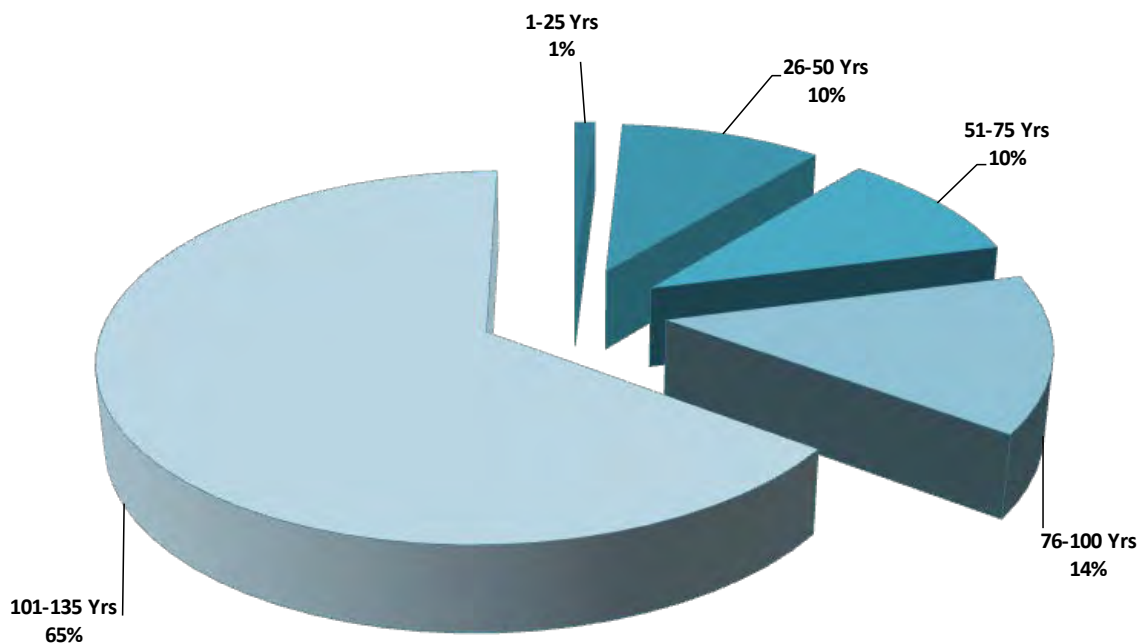
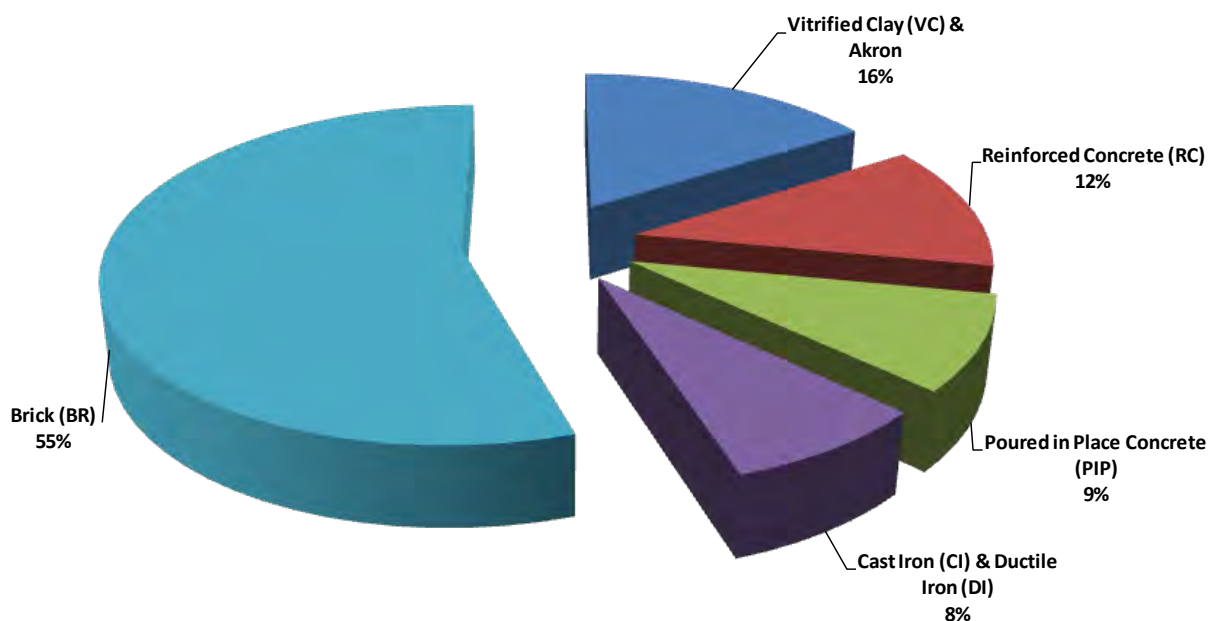

FIGURE 9-10 C-Rated Pipe By Material

Based on these results, staff selected a two-pronged approach focusing on risk and consequence of sewer failure to develop a methodology to prioritize C-rated gravity sewer sections for future rehabilitation/replacement. To assign points to pipe sections based on their risk-of-failure, staff developed a weighted scoring system using the factors that could best predict the condition of the pipe: sewer inspection condition rating, pipe age, and pipe material. To assign points to pipe sections based on their consequence-of-failure, staff developed a weighted scoring system based on land use analysis from GIS mapping data (such as, potentially impacted areas from SSOs, population density, residential/commercial/industrial land use, and areas of critical environmental concern). MWRA's wastewater hydraulic model was also used to deduct consequence-of-failure points from pipe sections that were less vulnerable due to the ability to divert or bypass flow in the event of a pipe failure.

After points were calculated for both risk-of-failure and consequence-of-failure components, sewer sections were sorted from high to low providing a prioritized list. All C-rated pipe (63 of 293 sewer sections) and B-rated pipe (230 of 293 sewer sections) were ranked using the risk-of-failure and consequence-of-failure methodology. A-rated and unrated pipe segments were not included in the analysis. Of a possible total score of 600 points, no pipe segments scored more than 500 points, 6 percent of pipe segments scored more than 400 points (all were C-rated), 39 percent scored 300 to 400 points (35 C-rated, 79 B-rated), 44 percent scored 200 to 300 points (11 C-rated, 120 B-rated) and the remaining 11 percent scored fewer than 200 points (all are B-rated). The outcome of the interceptor renewal methodology was a prioritized list of sewer sections to be considered for future rehabilitation/replacement. Below is a sample of the model output.

SECTION	Rank	CIP	Community (Length)	RATING	NDENSITY	NEUV_ARE	NCI_AREA	Vulnerability	Consequence points	Risk Points	Total Points
39	1	*	East Boston (3311)	C	90.00	70.00	76.00	-50.00	191.60	280.00	471.60
208	2	*	East Boston (92)	C	93.00	68.00	71.00	-50.00	190.80	280.00	470.80
37	3	*	East Boston (2945)	C	92.00	70.00	76.00	-50.00	194.40	272.00	466.40
240	4	*	Dorchester (204)	C	99.00	89.00	7.00	-50.00	181.80	271.94	453.74
242	5	*	Dorchester (60)	C	100.00	70.00	22.00	-50.00	173.20	280.00	453.20
81	6	*	Belmont (22); Cambridge (50)	C	100.00	96.00	88.00	-100.00	188.80	262.10	450.90
27	7	*	Cambridge (1185); Somerville (2562)	C	84.00	31.00	100.00	-37.25	171.35	272.00	443.35
26	8	*	Somerville (834)	C	71.00	31.00	66.00	0.00	170.00	272.00	442.00
164	9	*	Brighton (2997)	C	81.00	66.00	91.00	-82.95	151.05	272.00	423.05
610	10	*	Milton (1137)	C	52.00	79.00	7.00	-4.77	151.23	269.40	420.63
23	11	*	Everett (1361)	C	45.00	31.00	90.00	0.00	148.00	272.00	420.00
24	11	*	Everett (737)	C	45.00	31.00	90.00	0.00	148.00	272.00	420.00
528	13	*	West Roxbury (3897)	C	73.00	84.00	19.00	-50.00	147.60	272.00	419.60
156	14	*	Everett (297)	C	78.00	31.00	80.00	-50.00	138.20	272.00	410.20
80	15	*	Arlington (3608)	C	88.00	31.00	69.00	-62.28	133.32	271.84	405.16
73	16	*	Woburn (355)	C	100.00	31.00	25.00	-50.00	136.00	266.43	402.43
62	17	*	Chelsea (2365)	C	80.00	31.00	73.00	-50.00	136.80	264.00	400.80
2	18	*	Brighton (5836)	B	87.00	66.00	78.00	0.00	234.60	163.40	398.00
32	19	*	Charlestown (1518)	C	100.00	31.00	7.00	-50.00	125.20	272.00	397.20
14	20	*	Chelsea (1788)	C	97.00	31.00	94.00	-100.00	123.20	272.00	395.20
42	21	*	Melrose (642)	C	39.00	75.00	59.00	-50.00	115.00	280.00	395.00
527	22	*	West Roxbury (1223)	C	34.00	72.00	87.00	-50.00	121.80	272.00	393.80
15	23	*	Chelsea (617)	C	97.00	31.00	84.00	-100.00	117.20	272.00	389.20
607	24	*	Milton (1479)	C	11.00	82.00	36.00	0.00	119.00	269.40	388.40
53	25	*	Arlington (318)	C	89.00	31.00	40.00	-55.35	124.25	263.85	388.10

The interceptor renewal project team’s work resulted in the identification of 12 interceptor renewal/asset protection projects recommended to be completed during the 40-year Master Planning period. The projects are prioritized based on the interceptor renewal methodology for all C-rated sewer sections that have not been included in other previously programmed CIP projects. Periodic updates of the analysis, incorporating the most recent internal inspection data, are required. A review and update of the priority ranking of C-rated sections was being developed by MWRA’s Wastewater Engineering Department during FY14, based on most recent TV inspection data. Preliminary results from the review did not identified any C-rates pipe sections that had physical deterioration beyond that noted in prior TV inspections. The location of the 12 Interceptor Renewal Projects are shown on Figure 9-11. The first six interceptor renewal projects (and a portion of the overall cost for the seventh) are programmed in the FY14 CIP at a total cost of over \$40 million. The remaining interceptor renewal projects are recommended for consideration in future CIPs. All of the proposed interceptor renewal projects require a detailed engineering evaluation to determine the most appropriate sewer rehabilitation strategy. A 13th interceptor renewal project is a place-holder for future interceptor asset protection funding in the out years (FY39-53) of the Master Plan. The project is estimated at \$5 million per year (\$75 million over 15 years). Future projects will be identified through subsequent iterations of the interceptor renewal methodology (recommended to be performed by in-house staff every 5 years) as updated sewer inspection rating information is incorporated into the electronic sewer database.

As anticipated, some of the high priority sewer sections identified from the interceptor renewal methodology were included within ongoing or recently complete rehabilitation construction projects, or were already programmed into the CIP within planned interceptor projects. Some examples of previously rehabilitated C-rated sewers include: FY07 rehabilitation of Sewer Sections 80 and 83 in Arlington; FY08 rehabilitation of Sewer Section 160 in Winchester/Medford; FY10 rehabilitation of Sewer Section 624 in Weymouth; FY11 replacement of Sewer Sections 37, 39 and 208 in East Boston as part of the East Boston CSO Project; and FY11 replacement of Sewer Sections 526, 527, and 528 in West Roxbury under the Upper Neponset Valley Relief Sewer Project.



Section 624, Weymouth

FIGURE 9-11

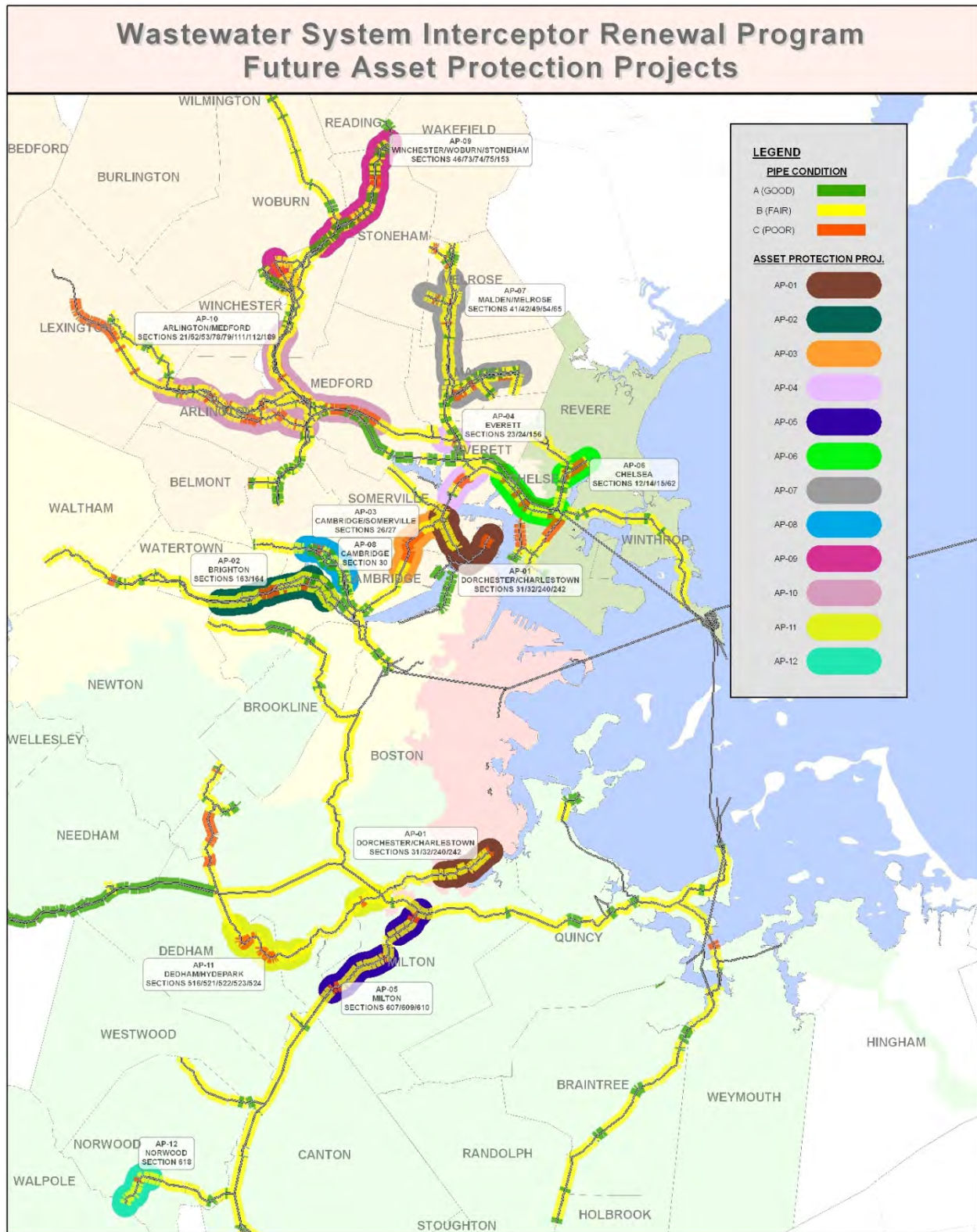

Phased construction of the sewer rehabilitation interceptor renewal projects will help ensure that the MWRA meets its goal of operating and maintaining the sewer system to provide uninterrupted wastewater collection service in a safe, cost-effective and environmentally sound manner with due attention to preserving and extending the useful life of sewer pipeline assets.



Example of sewer needing rehabilitation



Example of sewer rehabilitated with cured-in-place liner

During FY11-12, three additional gravity sewer asset protection projects were identified as high priority. A design/build rehabilitation of Sewer Section 156 in Everett was completed in FY12. Two additional projects are programmed in the FY14 CIP: (1) rehabilitation of sewer sections 186 and a portion of 4 at Deer Island in Boston and (2) rehabilitation of sewer sections 4, 5, and 6 in Winthrop (immediately upstream of sewer section 186). These projects are not included within the 12 interceptor renewal/asset protection projects.

Hydrogen Sulfide Corrosion and Odor Control: The Authority continues to address hydrogen sulfide corrosion and odor issues in the collection system; most notably in the Framingham Extension Sewer and Framingham Extension Relief Sewer, Wellesley Extension Relief Sewer and Wellesley Extension Sewer Replacement, West Roxbury Tunnel, and Millbrook Valley Relief Sewer Systems. For the Framingham and downstream interceptors, a 1998 report identified instances of corrosion and collapse dating back to 1977 and attributed the problem to high levels of biochemical oxygen demand (BOD) and sulfates. In 1999, MWRA proceeded with a multi-faceted corrosion and odor control program, including: (1) source reduction in the form of BOD, sulfate, and sulfide limits for municipal and industrial discharges; (2) treatment in the form of chemical addition and the installation of biofilters at key locations and, (3) asset protection through rehabilitation of affected sewers and related structures. A 2003 Wastewater Characterization Study identified the various components in MWRA's wastewater, with hydrogen sulfide being one of the more important parameters tested. As a follow-up, a project was developed to purchase and introduce chemicals in to the Framingham Extension Sewer system for hydrogen sulfide and corrosion control. Nitrogen based chemicals were used to provide an oxygen source to the wastewater, preventing or greatly reducing the formation of hydrogen sulfide. Monitoring is accomplished through aqueous and air space sampling. Internal TV and physical inspections continue to be prioritized for affected sewers and TRAC staff continue to oversee the pre-treatment work of municipalities and industries in the program.

Four projects to address hydrogen sulfide corrosion and odor control are programmed in the FY14 CIP, including: (1) FES/FERS In-System Biofilters, (2) FES Tunnel Rehabilitation, (3) System-Wide Odor Control Study, and (4) West Roxbury Tunnel Future Inspection. The West Roxbury Tunnel (MWRA Sewer Section 637/638) is a 2.8 mile long gravity tunnel with limited access that requires special operation and maintenance considerations. Previous MWRA internal inspections of the West Roxbury Tunnel have determined that approximately 12,000 feet of Section 637 is somewhat deteriorated due to hydrogen sulfide corrosion. The future inspection project, currently planned for FY20-21, will allow MWRA to monitor the structural condition in the West Roxbury Tunnel. Two related MWRA construction projects have been previously completed: (1) rehabilitation of 1,000 feet of Section 638 an 84-inch sewer upstream of the West Roxbury Tunnel between the Neponset Valley Connection Chamber and the New Haven Street Drop Shaft and (2) the New Haven Street Drop Shaft Rehabilitation.



Inspection in West Roxbury Tunnel

Gravity Sewer Asset Protection Projects Programmed in the FY14 CIP:

- Interceptor Renewal/Asset Protection Project #1 for rehabilitation construction of Sewer Sections 240, 241 and 242 in Dorchester is programmed in the FY14 CIP at a cost of \$4.8 million in FY15-19.
- Interceptor Renewal/Asset Protection Project #2 for rehabilitation design and construction of approximately 4,900 feet of Sections 163 and 164 in Brighton is programmed in the FY14 CIP at a cost of \$11.616 million in FY17-219.
- Interceptor Renewal/Asset Protection Project #3 for rehabilitation design and construction of approximately 4,400 feet of Sections 26 and 27 in Cambridge and Somerville is programmed in the FY14 CIP at a cost of \$5.0 million in FY22-23.
- Interceptor Renewal/Asset Protection Project #4 for rehabilitation design and construction of approximately 3,100 feet of Sections 23 and 24 in Everett is programmed in the FY14 CIP at a cost of \$3.0 million in FY25-26. Note that Sewer Section 156 was originally included within this project but was accelerated under a separate design/build rehabilitation project that was completed in FY12.
- Interceptor Renewal/Asset Protection Project #5 for rehabilitation design and construction of approximately 3,800 feet of Sections 607, 609 and 610 in Milton is programmed in the FY14 CIP at a cost of \$4.0 million in FY28-29.
- Interceptor Renewal/Asset Protection Project #6 for rehabilitation design and construction of approximately 6,000 feet of Sections 12, 14, 15 and 62 in Chelsea is programmed in the FY14 CIP at a cost of \$11.0 million in FY31-32.

- A portion of Interceptor Renewal/Asset Protection Project #7 for rehabilitation study, design, and construction of approximately 10,000 feet of Sections 41, 42, 49, 54 and 65 in Malden and Melrose is programmed in the FY14 CIP at a cost of \$1.3 million in FY19-23. In the FY14 CIP, this project has the title Malden and Melrose Hydraulic and Structural Study. Additional study of the hydraulic interactions of the sewers in the Malden and Melrose area will be performed prior to the development of a sewer rehabilitation plan.
- Sewer asset protection rehabilitation construction of Section 186 and a small portion of Section 4 on Deer Island, just upstream of the DITP, are programmed in the FY14 CIP at a cost of \$3.539 million in FY14-15. Emergency removal of delaminated plastic liner from Section 186 was performed in June 2011. The rehabilitation project will include 2,000 feet of 108-inch sewer pipe.
- Sewer asset protection rehabilitation design and construction of Section 4, 5, and 6 on the North Metropolitan Sewer in Winthrop is programmed in the FY14 CIP at a cost of \$13.0 million in FY15-20. The project will include rehabilitation of about 3,300 feet of 108-inch brick sewer that was rehabilitated using a shotcrete process in the 1990s.
- A corrosion and odor control project specific to design and construction of three biofilter air treatment systems to remove hydrogen sulfide from the Framingham Extension Sewer/Framingham Extension Relief Sewer (FES/FERS) and Wellesley Extension Sewer Replacement/Wellesley Extension Relief Sewer (WESR/WERS) is programmed in the FY14 CIP at a cost of \$2.759 million in FY19-22. Rehabilitation and/or replacement of hydrogen sulfide metering in the sewers is included in this project.
- A corrosion and odor control project specific to design and construction for rehabilitation of the Framingham Extension Sewer/Framingham Extension Relief Sewer (FES/FERS) Tunnel is programmed in the FY14 CIP at a cost of \$8.5 million in FY19-22.
- A System-wide Corrosion and Odor Control Study to evaluate needs and identify solutions for hydrogen sulfide corrosion and odor problems is programmed in the FY14 CIP at a cost of \$1.0 million in FY19-21.
- West Roxbury Tunnel Future Inspection to monitor hydrogen sulfide corrosion of concrete is programmed in the FY14 CIP at a cost of \$1.0 million in FY20-21. The West Roxbury Tunnel was inspected in 1999 and again in 2010 with negligible deterioration noted during that timeframe. A determination for future repair/rehabilitation of the tunnel will be made based on the results of future inspections.

Gravity Sewer Asset Protection Projects Recommended for Consideration in Future CIPs:

- Completion of Interceptor Renewal/Asset Protection Project #7 for rehabilitation study, design, and construction of approximately 10,000 feet of Sections 41, 42, 49, 54 and 65 in Malden and Melrose is recommended for consideration in future CIPs at an estimated cost of \$12.0 million in the FY24-28 timeframe. Note that apportion of this project may be completed under the Malden and Melrose hydraulic and structural study and construction project.
- Interceptor Renewal/Asset Protection Project #8 for rehabilitation of approximately 2,000 feet of Section 30 in Cambridge and Section 31 and 32 in Charlestown is recommended for consideration in future CIPs at an estimated cost of \$10.0 million in the FY24-28 timeframe. Note that Sewer Sections 31 and 32 in Charlestown were originally part of Interceptor Renewal/Asset Protection Project #1; however, this project was reduced in scope in the planning/design phase.

- Interceptor Renewal/Asset Protection Project #9 for rehabilitation of approximately 9,000 feet of Sections 46, 47, 73, 74, 75 and 153 in Winchester, Woburn and Stoneham is recommended for consideration in future CIPs at an estimated cost of \$12.0 million in the FY29-33 timeframe.
- Interceptor Renewal/Asset Protection Project #10 for rehabilitation of approximately 24,000 feet of Sections 21, 52, 53, 78, 79, 111, 112 and 189 in Arlington and Medford is recommended for consideration in future CIPs at an estimated cost of \$30.0 million in the FY29-33 timeframe.
- Interceptor Renewal/Asset Protection Project #11 for rehabilitation of approximately 7,200 feet of Sections 516, 521, 522, 523, and 524 in Dedham and Hyde Park is recommended for consideration in future CIPs at an estimated cost of \$15.0 million in the FY34-38 timeframe.
- Interceptor Renewal/Asset Protection Project #12 for rehabilitation of approximately 700 feet of Section 618 in Norwood is recommended for consideration in future CIPs at an estimated cost of \$3.0 million in the FY34-38 timeframe.
- Interceptor Renewal/Asset Protection Project #13 for a long-term CIP placeholder to provide an annual baseline target expenditure of \$5.0 million per year for interceptor asset protection and is recommended for consideration in future CIPs at an estimated cost of \$75.0 million in the FY39-53 timeframe. As specific projects are identified, they will become sub-phases within the target expenditure.
- Wellesley Extension Sewer Replacement (WESR) reevaluation for rehabilitation and/or relining of approximately 29,000 feet of sewer due to deterioration of the existing lining including design and construction is recommended for consideration in future CIPs at an estimated cost of \$30.0 million in the FY34-43 timeframe.

9.05 Sewer System Capacity and Optimization Projects

The majority of MWRA's past CIP funds spent on sewer interceptor projects were priorities due to sewer capacity issues identified through hydraulic modeling and facility planning projects and/or identified by sanitary sewer overflows (SSOs) during peak flow conditions associated with large storm events. Sewer capacity issues are generally addressed by constructing new facilities, typically a combination of sewer replacement and relief sewer construction. Many of MWRA's past projects to increase sewer capacity were originally recommended in the 1976 Wastewater Engineering and Management Plan for Eastern Massachusetts Metropolitan Area (EMMA) Study, individual facility plans for regional interceptors, the 1994 CSO/System Master Plan, etc. A hydraulic modeling project to evaluate the tributary flows and hydraulic capacity of the North Sewer System tributary to Chelsea Creek Headworks to determine the feasibility of optimizing and/or increasing system capacity is ongoing. Based on the outcome of the North System Hydraulic Study, similar hydraulic studies may be performed for the remainder of the MWRA regional sewer system (these projects are included in the list as recommended for consideration in future CIPs). The 2013 Wastewater System Master Plan does not include recommendations for future large scale capital projects to target capacity/optimization projects related to extreme event SSOs. Effective use of future capital resources to address extreme event SSOs will be investigated within the ongoing and recommended modeling/planning studies. Additional current and long-term regulatory issues and potential impacts on MWRA are detailed in Chapter 4. Existing sewer system capacity and optimization projects programmed in the FY14 CIP or recommended for consideration in future CIPs are presented below.

Gravity Sewer Capacity and Optimization Projects Programmed in the FY14 CIP:

- Completion of the Braintree/Weymouth Relief Facilities Project including design of modifications (Phase 2) to improve safety, reliability, odor control, solids handling, and performance of the facilities, land acquisition, and wetlands replication is programmed in the FY14 CIP at a cost of \$5.055 million in FY14-21.
- Braintree/Weymouth Relief Facilities Mill Cove Siphon Sluice Gates design and construction to allow staff to remotely flush out the siphon and reduce odors is programmed in the FY14 CIP at a cost of \$750,000 in FY18-19.
- Randolph Trunk Sewer Relief Study is programmed in the FY14 CIP at a cost of \$750,000 during FY19-21. The 3-year project will identify system improvements to reduce sanitary sewer overflows that occur at MWRA's Sewer Section 628 in the vicinity of the Pearl Street Siphon.
- Wastewater Process Optimization - North System Hydraulic Capacity Study to evaluate the tributary flows and hydraulic capacity of the North Sewer System tributary to Chelsea Creek Headworks and to determine the feasibility of increasing and/or optimizing system capacity is programmed in the FY14 CIP at a cost of \$259,000 during FY14. This project could help identify options to mitigate occasional SSOs in the North System during extreme storm events.
- Wastewater Process Optimization - North System Hydraulic Flood Engineering Analysis is programmed in the FY14 CIP at a cost of \$7.442 million during FY16-24. This project will follow-up on recommendations from the North System Hydraulic Capacity Study for optimization projects in the North System tributary to Chelsea Creek Headworks.
- A System Relief and Contingency Planning Study is programmed in the FY14 CIP at a cost of \$500,000 during FY21-24. This project will follow-up on recommendations from the North System Hydraulic Capacity Study for hydraulic optimization projects in the North System tributary to Chelsea Creek Headworks and/or other system relief projects identified for further study.
- Wastewater Process Optimization - Somerville/Medford Branch Sewer study, design, and construction is programmed in the FY14 CIP at a cost of \$1.234 million during FY18-20. This project will evaluate the feasibility and hydraulic optimization benefits of construction of a connection between the upstream end of the Somerville/Medford Branch Sewer and the North Metropolitan Relief Sewer to reduce surcharge and divert flow away from the Cambridge Branch Sewer and DeLauri Pump Station. The overall benefits and priority of this project may be further defined during the North System Hydraulic Capacity Study.

Gravity Sewer Capacity and Optimization Projects Recommended for Consideration in Future CIPs:

- Wastewater Process Optimization – Winthrop Terminal System Hydraulic Capacity Study to evaluate the tributary flows and hydraulic capacity of the North Sewer System tributary to Winthrop Terminal Headworks and to determine the feasibility of increasing and/or optimizing system capacity is recommended for consideration in future CIPs at an estimated cost of \$400,000 during FY15-16. This project would build on recommendations developed from the North System Hydraulic Capacity Study (tributary to Chelsea Creek Headworks) and could help identify options to mitigate occasional SSOs in the collection system during extreme storm events.

- Wastewater Process Optimization – Charles River System Hydraulic Capacity Study to evaluate the tributary flows and hydraulic capacity of the North Sewer System tributary to Ward Street and Columbus Park Headworks and to determine the feasibility of increasing and/or optimizing system capacity is recommended for consideration in future CIPs at an estimated cost of \$1.0 million during FY17-18. This project would build on recommendations developed from the North System Hydraulic Capacity Study (tributary to Chelsea Creek Headworks) and could help identify options to mitigate occasional SSOs in the collection system during extreme storm events.
- Wastewater Process Optimization - South System Hydraulic Capacity Study to evaluate the tributary flows and hydraulic capacity of the South Sewer System tributary to Nut Island Headworks and to determine the feasibility of increasing and/or optimizing system capacity is recommended for consideration in future CIPs at an estimated cost of \$1.0 million during FY22-23. This project would build on recommendations developed from the North System Hydraulic Capacity Study and could help identify options to mitigate occasional SSOs in the collection system during extreme storm events.
- Neponset Valley Sewer Capacity Relief planning, design, and construction project is recommended for consideration in future CIPs at an estimated cost of \$15.0 million during the FY24-33 timeframe. This project was initially recommended in the 1994 Final CSO Conceptual Plan and System Master Plan. The 3-mile long Neponset Valley Sewer was constructed during 1895-1898. The overall benefits and priority of this project may be further defined during the South System Hydraulic Capacity Study.
- Ashland Extension Sewer Capacity Relief planning and design project is recommended for consideration in future CIPs at an estimated cost of \$1.0 million during the FY29-33 timeframe. The project is recommended to identify the feasibility of extending the Framingham Relief Sewer to Ashland. The overall benefits and priority of this project may be further defined during the South System Hydraulic Capacity Study.

9.06 Gravity Sewer Manholes and Related Structures

Sewer manholes are generally constructed on gravity sewers approximately every 300 feet to provide access to the sewer pipeline. Manholes are also commonly constructed at each change in direction and slope. Other related structures (sometimes called special structures) found in the MWRA collection system include grit chambers (for collection of grit/debris), flow diversion chambers, regulators to direct flow to various pipes or outfalls, and tide gate chambers. MWRA's collection system contains about 4,000 manholes and other related structures. Siphons and siphon headhouse structures are discussed in Section 9.07. CSO and emergency outfalls are discussed in Section 9.09. Manholes and related structures require scheduled maintenance activities similar to other component of the collection system. The Technical Inspection Unit performs visual inspections of manholes/structures and assigns structural and infiltration ratings and maintains an inspection log and photo database. Each manhole or structure is scheduled for maintenance, rehabilitation, or re-inspection depending on its structural and infiltration rating. Replacement of manhole frames and covers and structural rehabilitation are prioritized and scheduled through MWRA's MAXIMO maintenance work order system. Funding for manhole and structure repairs has generally been through MWRA's annual current expense budget (CEB). MWRA has currently been targeting the rehabilitation of approximately 50 manholes each year through the expenditure of about \$90,000 in CEB funds (about \$1,800 per manhole). Plans are in place to increase the rate of manhole rehabilitation to a target of 100 manholes per year. In

addition, manholes and structures along the route of sewer rehabilitation projects are reviewed and rehabilitated, as appropriate, within each project. Staff recommend MWRA target long-term rehabilitation of 100 manholes per year (based on condition priority ranking) which will ultimately result in upgrade/rehabilitation of all 4,000 manholes/structures (100 percent of the system) over 40 years. Future manhole and special structure rehabilitation planning should consider potential increases in flood elevations and tidal surge due to impacts from climate change. It is likely that future manhole rehabilitation projects will continue to be funded through the annual CEB rather than as CIP projects. For Master Plan purposes, an Annual Manhole and Special Structure Rehabilitation project is recommended for consideration in future CIPs at a cost of \$200,000 per year (based on estimate of \$2000 per manhole at 100 manholes per year) for a total estimated cost of \$8.0 million for the 40-year FY14-53 timeframe. The Woburn Sand Catcher is a special structure that requires considerable maintenance; a specific project to improve debris removal from this structure is also recommended.

Manhole and Structure Projects Recommended for Consideration in Future CIPs:

- An Annual Manhole and Special Structure Rehabilitation project is recommended for consideration in future CIPs at a cost of \$200,000 per year (based on estimate of \$2000 per manhole at 100 manholes per year) for a total cost of \$8.0 million for the 40-year FY14-53 timeframe. Due to the annual need and relative low cost of this project, it is a candidate for CEB funding. Planning should consider potential increases in flood elevations and tidal surge due to impacts from climate change.
- A construction project to rehabilitate/upgrade the Woburn Sandcatcher is recommended for consideration in future CIPs at an estimated cost of \$1.0 million for the FY19-23 time frame. The project will optimize flow through the division structure, provide appropriate access for system maintenance, and improve debris removal. In-house planning and design will be required prior to implementation of this construction project.

9.07 Siphons and Siphon Headhouse Structures

Sewer siphons, more appropriately know as inverted siphons and also called depressed sewers, are gravity sewers designed to dip under an obstruction, such as a river, subway, conduit, etc. A siphon is always full of water under pressure below the hydraulic gradeline of the sewer. Sewer siphons are constructed with special inlet and outlet chambers (headhouses) to facilitate cleaning. Siphons may have one, two or multiple barrels, and flow is sometimes diverted into one barrel in order to obtain cleaning velocities in the pipe. Preventative maintenance for siphons is a priority for any collection system due to the likelihood of debris and grease build-up that can lead to pipeline blockages and SSOs. The MWRA collection system has 7 miles of siphons include more than 100 separate siphon barrels. Siphons account for about three percent of MWRA's wastewater collection system pipelines. Key information on MWRA siphons is provided in Table 9-3. A sample siphon design drawing is shown in Figure 9-12.

**TABLE 9-3
MWRA Siphons**

Name	Section #	Community	Material	Approximate Equivalent Diameter (in)	Year Built	Number of Barrels	Length of Longest Barrel (ft)	Total Length of Barrels (ft)
Alewife Brook Conduit	176	Medford	RC	60-66	1948	1	223	223
Alewife Brook Conduit	177	Arlington/Cambridge	RC	60-72	1948	1	553	553
Alewife Brook Conduit	178	Cambridge	RC	48	1948	1	224	224
Alewife Brook Conduit	179	Cambridge	RC	36	1948	1	152	152
Belmont Relief Sewer	081	Cambridge	CI	15	1927	3	23	66
Boston Marginal Conduit	222	Boston Main	PIPC, CI	60-86	1910	2	113	225
Braintree-Weymouth Interceptor	623	Quincy/Weymouth	DI/RC	60-120	1982	2	1706	3410
Braintree-Weymouth Interceptor	625	Weymouth	CI	48	1933	1	1597	1597
Braintree-Weymouth Interceptor	625	Braintree/Weymouth	CI	36	1933	1	743	743
Braintree-Weymouth Interceptor	624	Weymouth	PL/PIPC	37-42	1998	1	1948	1948
Emergency Mill Cove Relief Siphon								
Cambridge Marginal Conduit	229	Cambridge	CI	48	1910	2	202	402
Charles River Marginal Conduit	216	Boston	RC	36-84	1979	1	516	516
Charles River Marginal Conduit	217	Boston Main	RC	84	1979	1	396	396
Chelsea Creek Siphon	101	Chelsea/East Boston	PIPC	60	1942	2	925	1836
Dedham Branch Sewer	532	Canton/Dedham	CI	12	1950	2	110	219
DeLauri Pump Station	025	Charlestown	PIPC/RC	60-120	1895/1989	2	725	779
East Boston Branch Sewer Relief Project	256	East Boston	Brick, DI, RC	10-26	2010	2	167	344
Fore River Siphon	640	Weymouth	HDPE-ST, RC	36	2002	2	3680	7351
Framingham Extension Relief Sewer	678	Dover/Wellesley	PIPC	24	1999	2	195	389
Framingham Trunk Interceptor, Framingham Extension Sewer	632	Natick	RC	24	2002	2	227	453
Framingham Trunk Interceptor, Framingham Extension Sewer	634	Natick	RC	24	1954	2	55	109
High Level Sewer	564	Hyde Park/Milton	CI	60	1902	3	167	491
Metropolitan Sewer	059	Melrose	PIPC, CI	50-68	1901	2	95	189
Metropolitan Sewer	150	Winchester	Brick/VC	20-40	1894	1	57	57
Metropolitan Sewer	155	Medford/Somerville	Brick/CI	24-40	1894	1	99	99
Metropolitan Sewer, Cambridge Branch Sewer/DeLauri PS	025	Charlestown	Brick	60	1895	1	1106	1106
Metropolitan Sewer, Cummingsville Branch Sewer	047	Winchester	VC	15-20	1894	1	46	46
Metropolitan Sewer, New Malden River Siphon	019	Everett/Medford	Brick	48	1916	1	346	346
Millbrook Valley Relief Sewer	152	Arlington/Medford	RC	33-54	1966	2	576	1152
Millbrook Valley Sewer	078	Arlington/Medford	CI	15-34	1926	2	186	371
Millbrook Valley Sewer	084	Lexington	VC	12-22	1948	3	118	346
Mystic Valley Sewer	160	Winchester	CI	20	1878/1950	1	204	204
Neponset Valley Relief Sewer	531	Hyde Park/Milton	CI	30	1935	2	153	306
Neponset Valley Sewer	243	Dorchester/Milton	DI	8	1972	2	157	313
Neponset Valley Sewer	245	Dorchester/Milton	CI	8	1963	2	153	306
New Mystic Valley Sewer	067	Winchester	CI	54	1937	1	70	70
New Mystic Valley Sewer	069	Winchester	CI	20-30	1913	2	65	130
New Mystic Valley Sewer	109	Medford	CI, PIPC	48-66	1929	2	76	150
North Metro Relief Sewer	105	Everett/Medford	RC	60-92	1940	2	436	872
North Metro Relief Sewer	107	Medford	CI	54	1938	3	263	768
North Metro Relief Sewer	113	Winchester	CI, PIPC	36-56	1937	2	118	236
North Metro Relief Sewer	158	Medford	CI	54	1942	3	366	1089
North Metropolitan Trunk Sewer, Belle Isle Inlet	007	East Boston/Winthrop	PIPC	58	1895	3	237	705
Randolph Trunk Sewer	626	Braintree/Weymouth	RC	18-30	1973	3	86	256
Randolph Trunk Sewer	628	Braintree	RC	24	1972	2	58	115
Randolph Trunk Sewer	655	Braintree/Randolph	RC	15-28	1972	2	87	174
Walpole Ext Relief Sewer	669	Norwood	DI	30	1992	1	114	114
Walpole Ext Relief Sewer	669	Canton/Norwood	DI	30	1992	1	144	144
Walpole Extension Sewer	616	Canton/Norwood	CI	36	1931	1	103	103
Walpole Extension Sewer	617	Norwood	CI	36	1931	1	104	104
Walpole Extension Sewer	618	Norwood	CI, RC	18-30	1957	2	139	278
Watertown Coll System Improvements, East End Replacement Siphon	211	Brighton/Watertown	DI/RC	12-15	1984	2	255	504
Wellesley Ext Relief Sewer	629	Dedham/Needham	RC	36-60	1956	2	208	378
Wellesley Ext Relief Sewer	630	Dover/Needham	RC	24	1952	2	430	859
Wellesley Ext Sewer Replacement	666	Dedham/Needham	DI/RC	24-84	1990	3	249	498
Wellesley Ext Sewer Replacement	668	Dover/Wellesley	PIPC	36-60	1989	3	130	378
Wellesley Extension Sewer	601	Dedham/Needham	CI	12	1921	2	161	322
Westwood Interceptor, Westwood Extension Sewer	635	Canton/Westwood	RC	12-24	1961	3	321	961

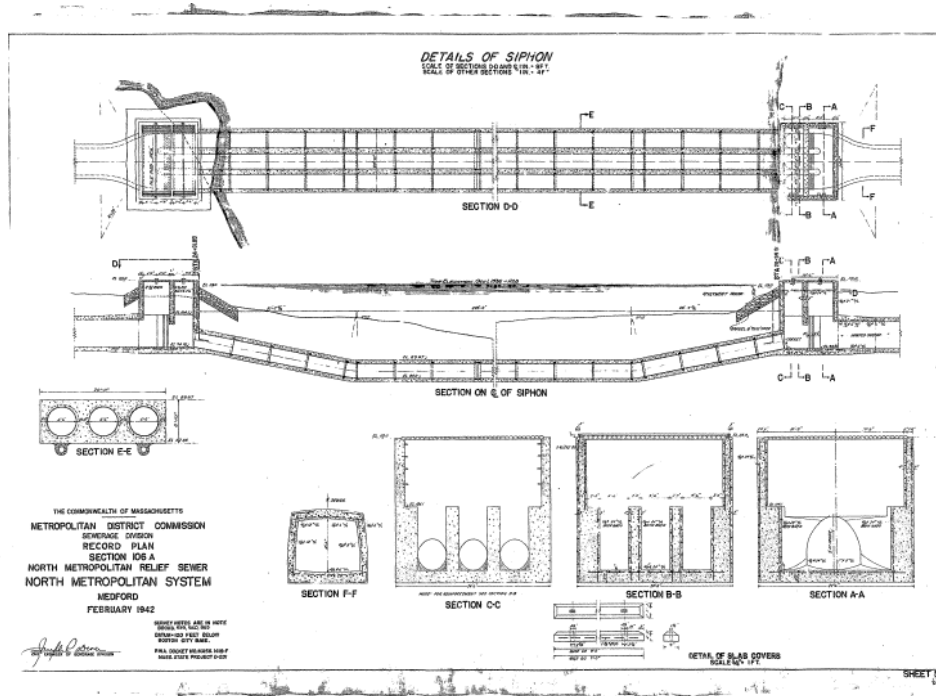

FIGURE 9-12 Example of a three barrel siphon

MWRA’s operation and maintenance practices for siphons relies in large part on use of sonar scanner inspection equipment. The sonar camera provides a video image of the pipe profile without need to dewater the siphon. This equipment is used as part of a prioritized O&M program to identify debris/grease build-up and pipe defects in all MWRA siphons. Follow-up maintenance and re-inspection are scheduled based on the results of sonar inspections.

Based on recent inspections, all MWRA’s siphons are in good condition. No siphon rehabilitation or replacement projects are recommended based on poor physical condition or specific physical defects. As a budget placeholder for long-term planning, a siphon asset protection project is recommended for future years. An additional project specific to Sewer Section 652, the Fore River Siphon, is also recommended. This project was previously a component of the Braintree/Weymouth Project and will provide sliplining design and construction to reduce the size of one of the existing 1,700 foot long twin 54-inch diameter Fore River Siphon barrels by inserting a 28-inch liner into one of the existing siphon barrels. Reduction in siphon size is needed due to the rerouting of significant flows to the Intermediate Pump Station.



Sonar Scanner

Inspection and maintenance of siphon headhouse structures is a regular part of MWRA’s scheduled maintenance practices. Both the physical condition and access to the siphon headhouse structures has been a concern for many years. In 1996, MWRA developed a comprehensive report (Siphon Chamber and Connecting Structures Inspection Summary Report) that provided documented results and recommendations from inspection of 146 siphon chambers and connecting structures



Siphon Headhouse

in the MWRA collection system. A project to design and construct improvements to siphon headhouse structures, based on the report recommendations, continues to be recommended by MWRA staff. The project will address capacity issues, detention time/odor issues, structural repairs, flow diversion using stop planks, structure accessibility, and easements issues. Phase 1 of the siphon structure rehabilitation project is programmed in the FY14 CIP, phases 2 and 3 are recommended for consideration in future CIPs.

Siphon and Siphon Headhouse Projects Programmed in the FY14 CIP:

- Wastewater Process Optimization – Siphon Planning Project at DeLauri Pump Station for further evaluation of the benefits of constructing a redundant siphon crossing the Mystic River from the Cambridge Branch Sewer to the DeLauri Pump Station is programmed in the FY14 CIP at a cost of \$150,000 during FY17-18. The overall benefits and priority of this project may be further defined during the North System Hydraulic Capacity Study.
- Siphon Structure Rehabilitation (Phase 1) for design and construction of the most critical recommended improvements to a portion of MWRA’s siphons and siphon headhouses is programmed in the FY14 CIP at a cost of \$4.664 million during FY15-19. This project will include hydraulic capacity review, structural repairs of deteriorated conditions, stop plank construction, installation of new covers and/or appropriate access structures, and procurement of legal access easements and land acquisition to allow for proper maintenance. Planning should consider potential increases in flood elevations and tidal surge due to impacts from climate change.

Siphon and Siphon Headhouse Projects Recommended for Consideration in Future CIPs:

- Sliplining design and construction of Section 652 Fore River Siphon to reduce the size of one of the existing 1,700 foot long twin 54-inch Fore River Siphon barrels by inserting a 28-inch liner into the existing siphon is recommended for consideration in future CIPs at an estimated cost of \$8.0 million in the FY19-23. Reduction in size is needed due to the rerouting of significant flows to the Intermediate Pump Station.
- As a follow-up to the Siphon Planning Project at the DeLauri Pump Station, a future siphon upgrade design and construction project (Cambridge Branch Sewer to the DeLauri Pump Station) is recommended for consideration for future CIPs at an estimated cost of \$25.0 million during the FY24-28 timeframe to provide a placeholder for design/construction funds awaiting the recommendations of the planning study.
- Phase 2 Siphon Structure Rehabilitation design and construction project is recommended for consideration in future CIPs at an estimated cost of \$4.0 million during the FY19-23 timeframe to make additional improvements (following Phase 1) to siphon headhouses and/or diversion structures. Planning should consider potential increases in flood elevations and tidal surge due to impacts from climate change.
- Phase 3 Siphon Structure Rehabilitation design and construction project is recommended for consideration in future CIPs at an estimated cost of \$4.0 million during the FY24-28 timeframe to make additional improvements (following Phase 2) to siphon headhouses and/or diversion structures. Planning should consider potential increases in flood elevations and tidal surge due to impacts from climate change.
- A Siphon Asset Protection project is recommended for consideration in future CIPs to provide an estimated \$5.0 million placeholder for possible recommendations from the ongoing in-house siphon inspection and maintenance program. This project is recommended for the FY24-28 timeframe.

9.08 Force Mains and Related Valves

Sewer force mains are the discharge piping from sewer pump stations that convey wastewater under pressure to a downstream gravity sewer. There are approximately 18 miles of force main piping in the MWRA collection system, accounting for about seven percent of wastewater collection system pipelines. Approximately 15.5 miles of force main are located outside the facilities they serve. The remaining 2.5 miles of force main piping is integral to the individual facilities. Key information on MWRA force mains is provided in Table 9-4.

MWRA has historically evaluated force mains for replacement/rehabilitation as an integral part of larger pump station replacement projects. However, two recent force main rehabilitation projects demonstrate the need for asset protection planning specifically for MWRA's force mains. The Mill Brook Valley Sewer Rehabilitation project (Sections 79 and 92) led to the identification that an upstream force main (Section 173 in Lexington) also required replacement due to hydrogen sulfide corrosion. In April 2010, an emergency repair project was required after failure of a 50-foot section of the Squantum Pump Station force main caused by internal hydrogen sulfide corrosion at a high point in the force main. The repair was made by installing 375 linear feet of cured-in-place liner inside the 30-inch diameter prestressed concrete cylinder pipe portion of the force main. A force main asset protection project that would evaluate the need for force main rehabilitation and prioritize project is recommended for consideration in future CIPs. Future planning, design, and construction for replacement of the Squantum Pump Station force main should be a high priority under this project.

Air relief valves are an important part of force mains designed to release air that enters or is trapped in the pipe. Because flowing water is subject to changing pressure and velocities, air is continuously coming out of solution when the force main is in service. Air relief valves are located at high points in the system where the air will accumulate. Serious flow restrictions or even blockage can result from the air pockets that form in the force main. Also, these air pockets can contain corrosive vapors and must be vented to reduce pipeline deterioration. Vacuum relief valves are equally important in force mains. These valves allow air to enter the force main if a vacuum condition occurs during situations such as pump startup, rapid shutdown, or sudden valve closure. An in-house task is recommended to review the performance of MWRA's force mains and evaluate age and material related factors. This force main task would expand on work being performed under the Water Master Plan for water main piping. This analysis may help predict force mains susceptible to failure. In addition, MWRA's air relief and vacuum valves and other force main related components should be reviewed to evaluate performance and O&M policies. Recommendations from this project may require a follow-up CIP project; a place holder is recommended below.

Force Main and Related Valve Projects Recommended for Consideration in Future CIPs:

- A Force Main Asset Protection Project is recommended to provide a place holder for additional rehabilitation of the Squantum Force Main, as well as future recommendations from an in-house force main and related structure evaluation. This project is estimated at \$20.0 million with a duration of 20-years and is recommended in the FY14-33 time frame. It is likely that the majority of force main rehabilitation or replacement construction will continue to be performed as part of larger pump station replacement projects (see Chapter 10).

**TABLE 9-4
MWRA Force Mains**

Facility/Location	Section	Size	Material*	Length (ft)	Date
Alewife Brook Pump Station/Somerville Pump #4	155	24-inch	CI	168	1948
Alewife Brook Pump Station/Somerville Pump #1, 2, 3	176	66-inch	RC	670	1948
Braintree/Weymouth Replacement Pump Station/Quincy	622	36-inch	DI	34	2007
Caruso Pump Station/East Boston	223	84-inch	RC	227	1985
DeLauri Pump Station/Charlestown	25	60-inch	PIPC	285	1989
Framingham Pump Station/Framingham Force Main extends into Natick	677	36-inch	PCCP	23,660	1999
Hayes Pump Station/Wakefield	205	20-inch	DI	2,330	1984
Hingham Pump Station/Hingham-Weymouth Force Main extends into Weymouth	661/662	20-inch	DI	7,921	1984/1990
Hough's Neck Pump Station/Quincy	588	10-inch	DI	43	1998
Intermediate Pump Station (IPS)/North Weymouth	642A	42-inch	DI	152	2000
Millbrook Valley Relief Sewer/Lexington	173	24-inch	DI	4,894	1967
New Neponset Valley Sewer Pump Station/Canton Force Main extends into Milton	675/676	48-inch	DI	21,409	1992
North Dorchester Bay CSO Storage and Pump Facilities/North Dorchester	TBD	24-inch	DI	4,000	2011
Prison Point Pump Station and Pumped CSO Facility/Cambridge	198 (dry weather)	18-inch	RC/DI	1,934	1974-1977
	199 (wet weather)	96-inch	RC/DI	2,193	1973-1974
Quincy Pump Station/Quincy	660	30-inch	CI - cement lined 1999	2,754	1923/1999
Squantum Pump Station/Quincy	659	24-inch	DI - CIPP lined 1995	4,582	1969/1995
	659A	30-inch	DI - cement lined 1999	8,115	1969-1970/1999
	659B	30-inch	PCCP	6,307	1970
Union Park CSO Facility/Boston		10-inch	DI	22	2007
Wiggins-Castle Island Terminal Pump Station/Boston	252	8-inch		265	1943/1960

*Notes for materials: CI - cast iron; CIPP - cured-in-place pipe; DI - ductile iron; PCCP - prestressed concrete cylinder pipe; PIPC - poured-in-place concrete pipe; RC - reinforced concrete

9.09 CSO and Nut Island Emergency Outfalls

Some of MWRA's member communities' wastewater collection systems were originally constructed as combined sewers to receive both sanitary flow and stormwater, including portions of Boston, Brookline, Cambridge, Chelsea, and Somerville. During larger storm events, wastewater flow may increase beyond the conveyance capacity of MWRA interceptors. Under these conditions, excess wastewater flow may be released to a nearby receiving waters via CSO outfalls. MWRA owns and operates some CSO outfalls, while the communities own and operate others. Each MWRA-owned CSO outfall has a specific designation number beginning with "MWR". Some CSO outfalls are downstream of CSO treatment facilities, other are not. In addition to CSO outfalls, MWRA owns and operates three emergency outfalls at the Nut Island Headworks that can be activated to discharge wastewater to Quincy Bay. Outfalls at the Deer Island Treatment Plant are discussed in Chapter 6.

The MWRA collection system includes 14 CSO and 3 Nut Island emergency outfalls. The total length of these outfall pipes is four miles, accounting for about one percent of wastewater collection system pipelines. Key information on CSO and Nut Island emergency outfalls is provided in Table 9-5. Under MWRA's CSO Control Plan (see Chapter 11), some of the MWRA-owned CSO outfalls have been closed, some will be closed when future projects are completed, and some will remain active. The Nut Island outfalls will remain active for emergency purposes. The Nut Island outfalls were inspected in 2005 and found to be in good condition. A future inspection project is recommended as a follow-up to the 2005 Nut Island outfall work and should also include inspection of all MWRA CSO outfalls. Project scheduling should be coordinated with CSO Control Plan projects. In addition to the recommended future project, one CSO outfall project (Outfall MWR023 Structural Improvements) is programmed in the FY14 CIP. MWRA performed a prior project to clean Outfall MWR023 from the MDC Gatehouse at Charlesgate (in the Fenway area of Boston) to the Charles River. The second portion of the project is to perform structural repairs to Outfall MWR023 during FY19-21.

Outfall Projects Programmed in the FY14 CIP:

- Outfall MWR023 Structural Improvements for future cleaning access and flow diversion is programmed in the FY14 CIP at a cost of \$1.5 million in FY19-21. Outfall 023 is at the end of the Stony Brook Conduit at the Charlesgate gatehouse.

Outfall Projects Recommended for Consideration in Future CIPs:

- A future Outfall Inspection/Assessment Project to provide inspection information and make recommendations for cleaning and/or asset protection repairs for all MWRA CSO and Nut Island emergency outfalls is recommended for consideration in future CIPs at an estimated cost of \$2.0 million in the FY24-26 timeframe.

**TABLE 9-5
MWRA CSO and Nut Island Emergency Outfalls**

Outfall	Section	Facility/Interceptor	Active/Closed	Approx Diameter (ft)	Length (ft)	Material	Year	Receiving Water
NI Emergency	543	NI Headworks	Active	5	5,275	Cast Iron	1904	Quincy Bay
NI Emergency	543-A	NI Headworks	Active	5	5,545	Cast Iron	1904	Quincy Bay
NI Emergency	543-B	NI Headworks	Active	5	1,395	Cast Iron	1914	Quincy Bay
MWRA003/CAM003	176	Alewife Brook Conduit	Active	5	117	Concrete	1950	Alewife Brook
MWR010	190-D	Charles River Valley Sewer	Active	7.5	162	Reinforced Concrete	1948	Lower Charles
MWR018	222-D	Boston Marginal Conduit	Active	6	123	Concrete	1910	Lower Charles
MWR019	222-E	Boston Marginal Conduit	Active	6.5	298	Concrete	1910	Lower Charles
MWR020	222-F	Boston Marginal Conduit	Active	8	378	Concrete	1910	Lower Charles
MWR021	222-G	Boston Marginal Conduit	Closed 3/00	6	207	Concrete	1910	Lower Charles
MWR022	222-H	Boston Marginal Conduit	Closed 3/00	6	387	Concrete	1910	Lower Charles
MWR023	222-A	Boston Marginal Conduit	Active	7	270	Concrete	1910	Lower Charles
MWR201	180-Z	Cottage Farm	Active	6	149	Reinforced Concrete	1967	Upper Charles
MWR203	199-A	Prison Point	Active	6	32	Reinforced Concrete	1973	Lower Charles
MWR205	230-A	Somerville Marginal Below Dam	Active	7	100	Reinforced Concrete	1971	Upper Mystic
MWR207	N/A	Constitution Beach (Decommissioned in 2000)	Closed 9/00					Constitution Beach
MWR209/BOS088/089	N/A	Fox Point (Decommissioned in 2008)	Closed 2008					South Dorchester Bay
MWR211/BOS090	N/A	Commercial Point (Decommissioned in 2008)	Closed 2008					South Dorchester Bay

9.10 SCADA and Wastewater Metering System

Supervisory Control and Data Acquisition (SCADA) systems provide a means of monitoring and controlling facilities and equipment from a remote centralized location, as well as providing a continuous record of facility operations. The wastewater metering system, comprised of over 200 metering devices, provides data for community flow-based rate assessments, hydraulic modeling, engineering studies, infiltration/inflow estimates, and operations support. Both the SCADA and Wastewater Metering Systems, as well as related existing and future CIP projects, are detailed in Chapter 12.

9.11 Summary of Existing and Recommended Capital Projects

All Master Plan projects related to collection system sewers are summarized in this Section. Table 9-6 lists each project, its priority ranking, and the proposed expenditure schedule. A description and needs justification for each project is listed in bullet format. This Section is provided as a summary of all existing and recommended capital projects; each project has been detailed previously in the Chapter within Sections relating to specific facilities or asset types.

Projects Programmed in the Existing FY14 CIP: There are twenty-three collection system sewer related projects programmed in the FY14 CIP. The projects are described below and summarized in Table 9-6 (see line numbers 9.1 through 9.23).

- Interceptor Renewal/Asset Protection Project #1 for rehabilitation construction of Sewer Sections 240, 241 and 242 in Dorchester is programmed in the FY14 CIP at a cost of \$4.8 million in FY15-19.
- Interceptor Renewal/Asset Protection Project #2 for rehabilitation design and construction of approximately 4,900 feet of Sections 163 and 164 in Brighton is programmed in the FY14 CIP at a cost of \$11.616 million in FY17-21.
- Interceptor Renewal/Asset Protection Project #3 for rehabilitation design and construction of approximately 4,400 feet of Sections 26 and 27 in Cambridge and Somerville is programmed in the FY14 CIP at a cost of \$5.0 million in FY22-23.
- Interceptor Renewal/Asset Protection Project #4 for rehabilitation design and construction of approximately 3,100 feet of Sections 23 and 24 in Everett is programmed in the FY14 CIP at a cost of \$3.0 million in FY25-26. Note that Sewer Section 156 was originally included within this project but was accelerated under a separate design/build rehabilitation project that was completed in FY12.
- Interceptor Renewal/Asset Protection Project #5 for rehabilitation design and construction of approximately 3,800 feet of Sections 607, 609 and 610 in Milton is programmed in the FY14 CIP at a cost of \$4.0 million in FY28-29.
- Interceptor Renewal/Asset Protection Project #6 for rehabilitation design and construction of approximately 6,000 feet of Sections 12, 14, 15 and 62 in Chelsea is programmed in the FY14 CIP at a cost of \$11.0 million in FY31-32.
- A portion of Interceptor Renewal/Asset Protection Project #7 for rehabilitation study, design, and construction of approximately 10,000 feet of Sections 41, 42, 49, 54 and 65 in Malden and Melrose is programmed in the FY14 CIP at a cost of \$1.3 million in FY19-23. In the FY14 CIP, this project has the title Malden and Melrose Hydraulic and Structural Study. Additional study of the hydraulic interactions of the sewers in the Malden and Melrose area will be performed prior to the development of a sewer rehabilitation plan.
- Sewer asset protection rehabilitation construction of Section 186 and a small portion of Section 4 on Deer Island, just upstream of the DITP, is programmed in the FY14 CIP at a cost of \$3.539 million in FY14-15. Emergency removal of delaminated plastic liner from Section 186 was performed in June 2011. The rehabilitation project will include 2,000 feet of 108-inch sewer pipe.

- Sewer asset protection rehabilitation design and construction of Section 4, 5, and 6 on the North Metropolitan Sewer in Winthrop is programmed in the FY14 CIP at a cost of \$13.0 million in FY15-20. The project will include rehabilitation of about 3,300 feet of 108-inch brick sewer that was rehabilitated using a shotcrete process in the 1990s.
- A corrosion and odor control project specific to design and construction of three biofilter air treatment systems to remove hydrogen sulfide from the Framingham Extension Sewer/Framingham Extension Relief Sewer (FES/FERS) and Wellesley Extension Sewer Replacement/Wellesley Extension Relief Sewer (WESR/WERS) is programmed in the FY14 CIP at a cost of \$2.759 million in FY19-22. Rehabilitation and/or replacement of hydrogen sulfide metering in the sewers is included in this project.
- A corrosion and odor control project specific to design and construction for rehabilitation of the Framingham Extension Sewer/Framingham Extension Relief Sewer (FES/FERS) Tunnel is programmed in the FY14 CIP at a cost of \$8.5 million in FY19-22.
- A System-wide Corrosion and Odor Control Study to evaluate needs and identify solutions for hydrogen sulfide corrosion and odor problems is programmed in the FY14 CIP at a cost of \$1.0 million in FY19-21.
- West Roxbury Tunnel Future Inspection to monitor hydrogen sulfide corrosion of concrete is programmed in the FY14 CIP at a cost of \$1.0 million in FY20-21. The West Roxbury Tunnel was inspected in 1999 and again in 2010 with negligible deterioration noted during that timeframe. A determination for future repair/rehabilitation of the tunnel will be made based on the results of future inspections.
- Completion of the Braintree/Weymouth Relief Facilities Project including design of modifications (Phase 2) to improve safety, reliability, odor control, solids handling, and performance of the facilities, land acquisition, and wetlands replication is programmed in the FY14 CIP at a cost of \$5.055 million in FY14-21.
- Braintree/Weymouth Relief Facilities Mill Cove Sluice Gates construction to allow staff to remotely flush out the siphon and reduce odors is programmed in the FY14 CIP at a cost of \$750,000 in FY18-19.
- Randolph Trunk Sewer Relief Study is programmed in the FY14 CIP at a cost of \$750,000 during FY19-21. The 3-year project will identify system improvements to reduce sanitary sewer overflows that occur at MWRA's Sewer Section 628 in the vicinity of the Pearl Street Siphon.
- Wastewater Process Optimization - North System Hydraulic Capacity Study to evaluate the tributary flows and hydraulic capacity of the North Sewer System tributary to Chelsea Creek Headworks and to determine the feasibility of increasing and/or optimizing system capacity is programmed in the FY14 CIP at a cost of \$259,000 during FY14. This project could help identify options to mitigate occasional SSOs in the North System during extreme storm events.

- Wastewater Process Optimization - North System Hydraulic Flood Engineering Analysis is programmed in the FY14 CIP at a cost of \$7.442 million during FY16-24. This project will follow-up on recommendations from the North System Hydraulic Capacity Study for hydraulic optimization projects in the North System tributary to Chelsea Creek Headworks.
- A System Relief and Contingency Planning Study is programmed in the FY14 CIP at a cost of \$500,000 during FY21-24. This project will follow-up on recommendations from the North System Hydraulic Capacity Study for hydraulic optimization projects in the North System tributary to Chelsea Creek Headworks and/or other system relief projects identified for further study.
- Wastewater Process Optimization - Somerville/Medford Branch Sewer study, design, and construction is programmed in the FY14 CIP at a cost of \$1.234 million during FY18-20. This project will evaluate the feasibility and hydraulic optimization benefits of construction of a connection between the upstream end of the Somerville/Medford Branch Sewer and the North Metropolitan Relief Sewer to reduce surcharge and divert flow away from the Cambridge Branch Sewer and DeLauri Pump Station. The overall benefits and priority of this project may be further defined during the North System Hydraulic Capacity Study.
- Wastewater Process Optimization – Siphon Planning Project at DeLauri Pump Station for further evaluation of the benefits of constructing a redundant siphon crossing the Mystic River from the Cambridge Branch Sewer to the DeLauri Pump Station is programmed in the FY14 CIP at a cost of \$150,000 during FY17-18. The overall benefits and priority of this project may be further defined during the North System Hydraulic Capacity Study.
- Siphon Structure Rehabilitation (Phase 1) for design and construction of the most critical recommended improvements to a portion of MWRA’s siphons and siphon headhouses is programmed in the FY14 CIP at a cost of \$4.664 million during FY15-19. This project will include hydraulic capacity review, structural repairs of deteriorated conditions, stop plank construction, installation of new covers and/or appropriate access structures, and procurement of legal access easements to allow for proper maintenance. Planning should consider potential increases in flood elevations and tidal surge due to impacts from climate change.
- Outfall MWR023 Structural Improvements for future cleaning access and flow diversion is programmed in the FY14 CIP at a cost of \$1.5 million in FY19-21. Outfall 023 is at the end of the Stony Brook Conduit at the Charlesgate gatehouse.

Projects Recommended for Consideration in Future CIPs: There are twenty-two collection system sewer related projects recommended for consideration in future CIPs. These projects are described below and summarized in Table 9-6 (see line numbers 9.24 through 9.45).

- Completion of Interceptor Renewal/Asset Protection Project #7 for rehabilitation study, design, and construction of approximately 10,000 feet of Sections 41, 42, 49, 54 and 65 in Malden and Melrose is recommended for consideration in future CIPs at an estimated

cost of \$12.0 million in the FY24-28 timeframe. Note that apportionment of this project may be completed under the Malden and Melrose hydraulic and structural study and construction project.

- Interceptor Renewal/Asset Protection Project #8 for rehabilitation of approximately 2,000 feet of Section 30 in Cambridge and Section 31 and 32 in Charlestown is recommended for consideration in future CIPs at an estimated cost of \$10.0 million in the FY24-28 timeframe. Note that Sewer Sections 31 and 32 in Charlestown were originally part of Interceptor Renewal/Asset Protection Project #1; however, this project was reduced in scope in the planning/design phase.
- Interceptor Renewal/Asset Protection Project #9 for rehabilitation of approximately 9,000 feet of Sections 46, 47, 73, 74, 75 and 153 in Winchester, Woburn and Stoneham is recommended for consideration in future CIPs at an estimated cost of \$12.0 million in the FY29-33 timeframe.
- Interceptor Renewal/Asset Protection Project #10 for rehabilitation of approximately 24,000 feet of Sections 21, 52, 53, 78, 79, 111, 112 and 189 in Arlington and Medford is recommended for consideration in future CIPs at an estimated cost of \$30.0 million in the FY29-33 timeframe.
- Interceptor Renewal/Asset Protection Project #11 for rehabilitation of approximately 7,200 feet of Sections 516, 521, 522, 523, and 524 in Dedham and Hyde Park is recommended for consideration in future CIPs at an estimated cost of \$15.0 million in the FY34-38 timeframe.
- Interceptor Renewal/Asset Protection Project #12 for rehabilitation of approximately 700 feet of Section 618 in Norwood is recommended for consideration in future CIPs at an estimated cost of \$3.0 million in the FY34-38 timeframe.
- Interceptor Renewal/Asset Protection Project #13 for a long-term CIP placeholder to provide an annual baseline target expenditure of \$5.0 million per year for interceptor asset protection and is recommended for consideration in future CIPs at an estimated cost of \$75.0 million in the FY39-53 timeframe. As specific projects are identified, they will become sub-phases within the target expenditure.
- Wellesley Extension Sewer Replacement (WESR) reevaluation for rehabilitation and/or relining of approximately 29,000 feet of sewer due to deterioration of the existing lining including design and construction is recommended for consideration in future CIPs at an estimated cost of \$30.0 million in the FY34-43 timeframe.
- Wastewater Process Optimization – Winthrop Terminal System Hydraulic Capacity Study to evaluate the tributary flows and hydraulic capacity of the North Sewer System tributary to Winthrop Terminal Headworks and to determine the feasibility of increasing and/or optimizing system capacity is recommended for consideration in future CIPs at an estimated cost of \$400,000 during FY15-16. This project would build on recommendations developed from the North System Hydraulic Capacity Study (tributary

to Chelsea Creek Headworks) and could help identify options to mitigate occasional SSOs in the collection system during extreme storm events.

- Wastewater Process Optimization – Charles River System Hydraulic Capacity Study to evaluate the tributary flows and hydraulic capacity of the North Sewer System tributary to Ward Street and Columbus Park Headworks and to determine the feasibility of increasing and/or optimizing system capacity is recommended for consideration in future CIPs at an estimated cost of \$1.0 million during FY17-18. This project would build on recommendations developed from the North System Hydraulic Capacity Study (tributary to Chelsea Creek Headworks) and could help identify options to mitigate occasional SSOs in the collection system during extreme storm events.
- Wastewater Process Optimization - South System Hydraulic Capacity Study to evaluate the tributary flows and hydraulic capacity of the South Sewer System tributary to Nut Island Headworks and to determine the feasibility of increasing and/or optimizing system capacity is recommended for consideration in future CIPs at an estimated cost of \$1.0 million during FY22-23. This project would build on recommendations developed from the North System Hydraulic Capacity Study and could help identify options to mitigate occasional SSOs in the collection system during extreme storm events.
- Neponset Valley Sewer Capacity Relief planning, design, and construction project is recommended for consideration in future CIPs at an estimated cost of \$15.0 million during the FY24-33 timeframe. This project was initially recommended in the 1994 Final CSO Conceptual Plan and System Master Plan. The 3-mile long Neponset Valley Sewer was constructed between 1895-1898. The overall benefits and priority of this project may be further defined during the South System Hydraulic Capacity Study.
- Ashland Extension Sewer Capacity Relief planning and design project is recommended for consideration in future CIPs at an estimated cost of \$1.0 million during the FY29-33 timeframe. The project is recommended to identify the feasibility of extending the Framingham Relief Sewer to Ashland. The overall benefits and priority of this project may be further defined during the South System Hydraulic Capacity Study.
- An Annual Manhole and Special Structure Rehabilitation project is recommended for consideration in future CIPs at a cost of \$200,000 per year (based on estimate of \$2000 per manhole at 100 manholes per year) for a total estimated cost of \$8.0 million for the 40-year FY14-53 timeframe. Due to the annual need and relative low cost of this project, it is anticipated to continue to be a candidate for CEB funding. Planning should consider potential increases in flood elevations and tidal surge due to impacts from climate change.
- A construction project to rehabilitate/upgrade the Woburn Sandcatcher is recommended for consideration in future CIPs at an estimated cost of \$1.0 million for the FY19-23 time frame. The project will optimize flow through the division structure, provide appropriate access for system maintenance, and improve debris removal. In-house planning and design will be required prior to implementation of this construction project.

- Sliplining design and construction of Section 652 Fore River Siphon to reduce the size of one of the existing 1,700 foot long twin 54-inch Fore River Siphon barrels by inserting a 28-inch liner into the existing siphon is recommended for consideration in future CIPs at an estimated cost of \$8.0 million in the FY19-23. Reduction in size is needed due to the rerouting of significant flows to the Intermediate Pump Station.
- As a follow-up to the Siphon Planning Project at the DeLauri Pump Station, a future siphon upgrade design and construction project (Cambridge Branch Sewer to the DeLauri Pump Station) is recommended for consideration for future CIPs at an estimated cost of \$25.0 million during the FY24-28 timeframe to provide a placeholder for design/construction funds awaiting the recommendations of the planning study.
- Phase 2 Siphon Structure Rehabilitation design and construction project is recommended for consideration in future CIPs at an estimated cost of \$4.0 million during the FY19-23 timeframe to make additional improvements (following Phase 1) to siphon headhouses and/or diversion structures. Planning should consider potential increases in flood elevations and tidal surge due to impacts from climate change.
- Phase 3 Siphon Structure Rehabilitation design and construction project is recommended for consideration in future CIPs at an estimated cost of \$4.0 million during the FY24-28 timeframe to make additional improvements (following Phase 2) to siphon headhouses and/or diversion structures. Planning should consider potential increases in flood elevations and tidal surge due to impacts from climate change.
- A Siphon Asset Protection project is recommended for consideration in future CIPs to provide an estimated \$5.0 million placeholder for possible recommendations from the ongoing in-house siphon inspection and maintenance program. This project is recommended for the FY24-28 timeframe.
- A Force Main Asset Protection Project is recommended to provide a place holder for additional rehabilitation of the Squantum Force Main, as well as future recommendations from an in-house force main and related structure evaluation. This project is estimated at \$20.0 million with a duration of 20-years and is recommended in the FY14-33 time frame. It is likely that the majority of force main rehabilitation or replacement construction will continue to be performed as part of larger pump station replacement projects (see Chapter 10).
- A future Outfall Inspection/Assessment Project to provide inspection information and make recommendations for cleaning and/or asset protection repairs for all MWRA CSO and Nut Island emergency outfalls is recommended for consideration in future CIPs at an estimated cost of \$2.0 million in the FY24-26 timeframe.

**Table 9-6
Wastewater Master Plan - Collection System Sewers
Existing and Recommended Projects**

Last revision 8/6/13

Line No	Priority	Project	Project Type	FY14 CIP Project No.	FY14 CIP Contract No.	Project Duration	Cost (\$1000)	Schedule	FY14 CIP Notes					Total Cost (\$1000)
									5 years		10 years		20 years	
COLLECTION SYSTEM SEWERS														
9.01	2	Interceptor Renewal #1 - Dorchester Sections 240, 241, 242 - Design and Construction	AP	145	10447_7163 10448_7164	5 years	4,800	FY15-19	4,600	200				4,800
9.02	2	Interceptor Renewal # 2 - Brighton Sections 163/164 Design/CA/RE/Construction	AP	145	10504_7410 10418_6936	5 years	11,616	FY17-21	565	11,051				11,616
9.03	2	Interceptor Renewal # 3 Cambridge/Somerville Sections 26/27 Planning/Design/Construction	AP	145	10467_7279	2 years	5,000	FY22-23		5,000				5,000
9.04	2	Interceptor Renewal # 4 Everett Sections 23/24 Planning/Design/Construction	AP	145	10468_7280	2 years	3,000	FY25-26			3,000			3,000
9.05	2	Interceptor Renewal # 5 Milton Sections 607/609/610 Planning/Design/Construction	AP	145	10481_7328	2 years	4,000	FY28-29			4,000			4,000
9.06	2	Chelsea Sections 12/14/15/62 Planning/Design/Construction	AP	145	10482_7329	2 years	11,000	FY31-32			11,000			11,000
9.07	2	Malden/Melrose Hydraulic & Structural Study and Portion of Interceptor Renewal # 7 - Planning/Design/Construction	Plan/AP	145	10457_7216 10458_7217	5 years	1,300	FY19-23		1,300				1,300
9.08	2	Rehabilitation of Sections 186 and 4 - Construction	AP	145	10507_7423	2 years	3,539	FY14-15	3,539					3,539
9.09	2	Section 4.5.6 North Met Sewer Rehabilitation Design/CS/RI/Construction	AP	145	10505_7421 10506_7422	6 years	13,000	FY15-20	5,058	7,942				13,000
9.10	2	Corrosion & Odor Control - FES /FERS Biofilters Design and Construction	AP	132	10406_6919 10456_7215	4 years	2,759	FY19-22		2,759				2,759
9.11	2	Corrosion & Odor Control - FES Tunnel Rehab Design and Construction	AP	132	10453_7196 10405_6918	4 years	8,500	FY19-22		8,500				8,500
9.12	3	Corrosion & Odor Control - System-Wide Odor Control Study	Plan	132	10491_7364	3 years	1,000	FY19-21		1,000				1,000
9.13	2	West Roxbury Tunnel - Future Tunnel Inspection	AP	136	10401_6898	2 years	1,000	FY20-21		1,000				1,000

**Table 9-6
Wastewater Master Plan - Collection System Sewers
Existing and Recommended Projects**

Last revision 8/6/13

Line No	Priority	Project	Project Type	FY14 CIP Project No.	FY14 CIP Contract No.	Project Duration	Cost (\$1000)	Schedule	FY14 CIP Notes					Total Cost (\$1000)
									FY14-18	FY19-23	FY24-33	FY34-53	20 years	
9.14	3	Braintree/Weymouth Relief Facilities - B/W Improvements Design CS/RI, Land Acquisition, and Wetlands Replication	Opti	104	10048_5314 10470_7290 10493_7366 19567_9586	8 years	5,055	ongoing-FY21	1,289	3,766				5,055
9.15	3	Braintree-Weymouth Relief Facilities - Mill Cove Siphon Sluice Gates Design and Construction	Opti	104	10479_7326 10480_7327	2 years	750	FY18-19	75	675				750
9.16	3	Randolph Trunk Sewer Relief Study	Plan	147	10461_7220	3 years	750	FY19-21		750				750
9.17	2	Wastewater Process Optimization - North System Hydraulic Capacity Study	Plan	141	10412_6930	1 year	259	ongoing-FY14	259					259
9.18	3	Wastewater Process Optimization - North System Hydraulic Flood Engineering Analysis	Opti	141	19401_7412	9 years	7,442	FY16-24	2,093	4,651	698			7,442
9.19	2	System Relief and Contingency Planning	Plan	145	10487_7360	4 years	500	FY21-24		458	42			500
9.20	3	Wastewater Process Optimization - Somerville/Medford Branch Sewer Study/Design/Construction	Opti	141	10413_6931 10414_6932	3 years	1,234	FY18-20	40	1,194				1,234
9.21	3	Wastewater Process Optimization - Siphon Planning at DeLauri PS	Plan	141	10415_6933	2 years	150	FY17-18	150					150
9.22	2	Siphon Structure Rehab Phase 1 - Land Acquisition Design/CS/RI & Construction	AP	130	10280_6165 10293_6224 10294_6225	5 years	4,664	FY15-19	4,561	83				4,664
9.23	3	South System Relief/Outfall #023 Structural Improvements	Opti	139	10386_6601	3 years	1,500	FY19-21		1,500				1,500
SUBTOTAL - Existing - Sewers										22,249	51,829	18,740		92,818

**Table 9-6
Wastewater Master Plan - Collection System Sewers
Existing and Recommended Projects**

Last revision 8/6/13

Line No	Priority	Project	Project Type	FY14 CIP Project No.	FY14 CIP Contract No.	Project Duration	Cost (\$1000)	Schedule	FY14 CIP Notes				Total Cost (\$1000)
									5 years	5 years	10 years	20 years	
9.24	2	Completion of interceptor renewal #7 Maiden/Melrose Sections 41/42/49/54/65	AP	new		5 years	12,000	FY24-28			12,000		12,000
9.25	3	Interceptor renewal #8 Cambridge Section 30, Charlestown Section 31 & 32	AP	new		5 years	10,000	FY24-28			10,000		10,000
9.26	3	Interceptor renewal #9 Winchester/Woburn/Stonham Sections 46/47/73/74/75/153	AP	new		5 years	12,000	FY29-33			12,000		12,000
9.27	3	Interceptor renewal #10 Arlington/Medford Sections 21/52/53/78/79/111/112/189	AP	new		5 years	30,000	FY29-33			30,000		30,000
9.28	3	Interceptor renewal #11 Dearham/Hyde Park Sections 516/524/522/523/524	AP	new		5 years	15,000	FY34-38			15,000		15,000
9.29	3	Interceptor renewal #12 Norwood Section 618	AP	new		5 years	3,000	FY34-38			3,000		3,000
9.30	3	Interceptor renewal #13 Future @ \$5 mill/year	AP	new		annual	75,000	FY39-53			75,000		75,000
9.31	3	Wellesley Extension Replacement Sewer Rehab Design/Construction/CSIRI	AP	new		10 years	30,000	FY34-43			30,000		30,000
9.32	3	Wastewater Process Optimization - W/rihrop Terminal System Hydraulic Capacity Study	Plan	new		2 years	400	FY15-16	400				400
9.33	3	Wastewater Process Optimization - Charles River System Hydraulic Capacity Study	Plan	new		2 years	1,000	FY17-18	1,000				1,000
9.34	3	Wastewater Process Optimization - South System Hydraulic Capacity Study	Plan	new		2 years	1,000	FY22-23	1,000				1,000
9.35	4	Norset Valley Sewer Capacity Relief - Planning/Design/Construct	RF/IC	new		10 years	15,000	FY24-33			15,000		15,000
9.36	5	Ashland Extension Sewer Capacity Relief - Planning/Design	Plan/NF	new		5 years	1,000	FY29-33			1,000		1,000
9.37	4	Manhole Rehabilitation @ \$200k/year	AP	new		annual	8,000	FY14-53	1,000		2,000	4,000	8,000
9.38	4	Woburn Sandcatcher Upgrade Construction	AP/Opti	new		5 years	1,000	FY19-23			1,000		1,000
9.39	4	Slipring of Section 652 Fore River Siphon in the BWV System - Design/Construction	AP/Opti	new		5 years	8,000	FY19-23			8,000		8,000
9.40	3	Siphon Upgrade Design/Construction at the DeLauri PS Mystic River Crossing	IC/Opti	new		5 years	25,000	FY24-28			25,000		25,000
9.41	2	Phase 2 Siphon Structure Rehab Design/Construct	AP	new		5 years	4,000	FY19-23			4,000		4,000
9.42	2	Phase 3 Siphon Structure Rehab Design/Construct	AP	new		5 years	4,000	FY24-28			4,000		4,000
9.43	4	Siphon Asset Protection	AP	new		5 years	5,000	FY24-28			5,000		5,000
9.44	4	Force Main Asset Protection	AP	new		20 years	20,000	FY14-33	5,000		5,000	10,000	20,000
9.45	4	Outfall Asset Protection	AP	new		3 years	2,000	FY24-26			2,000		2,000
SUBTOTAL - Recommended - Sewers							282,400		7,400	20,000	128,000	127,000	282,400
SUBTOTAL - Existing and Recommended - Sewers							375,218		29,649	71,829	146,740	127,000	375,218

CHAPTER 10

COLLECTION SYSTEM

PUMP STATIONS AND CSO FACILITIES

10.01 Chapter Summary

MWRA's wastewater collection system is a complex network of conduits and facilities that is strongly influenced by seasonal and wet weather conditions. The system average daily flow is approximately 360 mgd, minimum dry weather flow is approximately 260 mgd and peak wet weather capacity to the Deer Island Treatment Plant (DITP) is 1,270 mgd with additional system capacity available at combined sewer overflow (CSO) outfalls. The MWRA collection system includes a network of 274 miles of sewer pipelines (19 miles of cross-harbor tunnels, 226 miles of gravity sewers, 18 miles of force mains, 7 miles of siphons, and 4 miles of CSO and emergency outfalls); 13 pump stations; one screening facility; six CSO treatment/storage facilities; and four remote headworks facilities.

In this Chapter, MWRA's collection system pump stations, screening facility, and CSO facilities are detailed. MWRA's remote headworks facilities are detailed in Chapter 8. The primary function of a pump station is to lift wastewater from an upstream sewer (at a lower elevation) to a downstream interceptor (at a higher elevation) so the wastewater can continue to flow by gravity to MWRA headworks facilities. Most pump stations operate continuously; however, two MWRA pump stations (Framingham and New Neponset Valley Sewer Pump Stations) are designed to operate during peak flows (wet weather) only. The primary function of a combined sewer overflow (CSO) facility is to treat combined (i.e. sanitary and stormwater) flow that exceeds the capacity of the combined sewer system in large rainfall events before releasing the excess flow to nearby receiving waters. CSO facilities also operate only during wet weather. MWRA's goal is to operate and maintain all wastewater facilities to provide uninterrupted wastewater collection and treatment service in a safe, cost-effective and environmentally sound manner.

The replacement asset value of the pump stations and CSO facilities is \$630 million (9% of wastewater system asset value). See detail on Wastewater Infrastructure Replacement Asset Value in Section 3.07. The facilities are detailed within the Chapter Section noted below:

- 10.03 Alewife Brook Pump Station
- 10.04 BOS019 CSO Storage Conduit
- 10.05 Braintree/Weymouth Replacement Pump Station
- 10.06 Caruso Pump Station
- 10.07 Chelsea Screen House
- 10.08 Cottage Farm Pumped CSO Facility
- 10.09 DeLauri Pump Station
- 10.10 Framingham Pump Station
- 10.11 Hayes Pump Station
- 10.12 Hingham Pump Station
- 10.13 Hough's Neck Pump Station
- 10.14 Intermediate Pump Station (IPS)

- 10.15 New Neponset Valley Sewer Pump Station
- 10.16 North Dorchester Bay CSO Storage and Pump Facilities
- 10.17 Prison Point Pump Station and Pumped CSO Facility
- 10.18 Quincy Pump Station
- 10.19 Somerville Marginal Gravity CSO Facility
- 10.20 Squantum Pump Station
- 10.21 Union Park CSO Facility
- 10.22 Wiggins - Castle Island Terminal Pump Station
- 10.23 Braintree Howard Street Pump Station
- 10.24 Decommissioned Facilities and Historical Structures

The average age of MWRA's 20 collection system facilities is 21 years. Only five of the 20 facilities are more than 25 years old. The oldest pump station, Alewife Brook in Somerville, is 61 years old. Two of MWRA's CSO facilities are 41 years old: the Cottage Farm Pumped CSO Facility and the Somerville Marginal Gravity CSO Facility. MWRA's newest facilities include four that are five years old or newer: BOS019 CSO Storage Facility in Charlestown, Braintree/Weymouth Replacement Pump Station in Quincy, North Dorchester Bay CSO Storage and Pump Facilities in South Boston, and Union Park CSO Facility in Boston's South End.

Overall, the 20 collection system facilities are in good condition. Significant automation upgrades were implemented under MWRA's Wastewater Central Monitoring/SCADA Implementation Project (see Chapter 12). The CSO facilities have undergone upgrades under the CSO Control Plan and two of the former CSO stations (Commercial Point and Fox Point) were decommissioned in 2008 following completion of local sewer separation projects. The highest priority immediate needs for wastewater pump stations and CSO facilities are rehabilitation/replacement projects being implemented at the 10 older facilities. Once planning/design is complete and appropriate construction costs for these upgrade projects are programmed in future CIPs, planning and condition assessment for the newer facilities will begin. Also recommended is the creation of annual baseline target expenditures for asset protection projects for wastewater pump station and CSO facilities over the long term at an annual budget of \$2.0 million during the FY24-53 period. As specific small scale rehabilitation and equipment replacement projects are identified, they will become sub-phases within the target expenditure CIP budget. Prioritization of asset protection projects is a consistent theme throughout the Master Plan. This target expenditure is needed as a place-holder to fund smaller scale projects that, individually, may not be seen as high priority, but are critical to maintaining uninterrupted service in a safe, cost-effective and environmentally sound manner.

For wastewater pump station and CSO facilities, operability of mechanical equipment and maintenance of electric/standby power systems are key elements to minimize risk of facility failure. Malfunction of mechanical equipment may impact sewer service, particularly during large storm events that stress the hydraulic capacity of the facilities, potentially requiring facility shutdown which could result in upstream CSOs and/or potential SSOs. Facilities most impacted by hydrogen sulfide corrosion are likely to require more frequent maintenance and earlier equipment replacement. Key decision making to minimize risks includes the cost/benefit decision of when to replace aging equipment and which/how many spare parts to pre-purchase. Other wastewater facility uncertainties include the future costs of chemicals and power.

For the pump stations and CSO facilities, \$315.965 million in projects is identified in the 40-year master plan timeframe (FY14-53). Twelve projects (\$27.965 million) are currently programmed in the FY14 CIP. Fifteen additional projects (\$288.0 million) are recommended for consideration in future CIPs. Section 10.26 – Summary of Existing and Recommended Capital Projects includes a consolidated list of all projects recommended in this Chapter.

Near-term (FY14-18):

- \$27.621 million is programmed in the FY14 CIP:
 - \$9.926 million for Alewife Brook Pump Station improvements design and construction;
 - \$3.0 million for pump station and CSO facility assessment for the 10 older facilities;
 - \$406,000 to begin the preliminary design/study for rehabilitation of 6 of 10 older pump station and CSO facilities;
 - \$2.916 million for Caruso Pump Station improvements for generator replacement, HVAC, and fire detection system replacement design and construction;
 - \$3.3 million for Chelsea Screen House design and construction upgrades including screens and gates;
 - \$1.0 million for Prison Point and Cottage Farm CSO Facility rehabilitation preliminary design/study;
 - \$5.099 million for Prison Point and Cottage Farm CSO Facility upgrades including generators and Prison Point CSO Facility pump and gearbox rebuilds/rehabilitation.
 - \$26,000 to complete Cottage Farm CSO Facility fuel system upgrade;
 - \$407,000 for DeLauri Pump Station Improvements for electrical room cooling and security upgrade design and construction;
 - \$460,000 for Prison Point CSO Facility HVAC upgrades design and construction;
 - \$331,000 for Prison Point CSO Facility piping rehabilitation; and,
 - \$750,000 for Prison Point CSO Facility dry weather flow and stripping pump improvements.

- \$3.0 million in needs is identified for FY14-18 and recommended for consideration in future CIPs for the Wiggins – Castle Island Terminal Pump Station upgrades and generator addition design and construction project.

Mid-term (FY19-23):

- \$344,000 is programmed in the FY14 CIP to complete the preliminary design/study for rehabilitation of 6 of 10 older pump station and CSO facilities.

- \$86.0 million in needs is identified for FY19-23 and recommended for consideration in future CIPs:
 - \$500,000 for Facility Emergency Response plan/hydraulic review project;
 - \$25.0 million for Caruso Pump Station upgrades design and construction;
 - \$10.0 million to begin Cottage Farm Pumped CSO upgrades design and construction;
 - \$25.0 million for DeLauri Pump Station upgrades design and construction;
 - \$1.5 million for Framingham Pump Station force main corrosion and odor improvements;
 - \$500,000 for Framingham Pump Station sluice gate replacement design and construction;

- \$500,000 for Framingham Pump Station screening automation study, design and construction;
- \$6.0 million to begin the Hayes Pump Station upgrades design and construction;
- \$5.0 million to begin the Hingham Pump Station upgrades design and construction;
- \$10.0 million to begin the Prison Point Pump Station and Pumped CSO Facility upgrades design and construction; and,
- \$2.0 million to begin the Somerville Marginal Gravity CSO Facility upgrades design and construction;

Long-term (FY24-33 and FY34-53):

- \$199.0 million in needs is identified for FY24-33 and FY34-53 and recommended for consideration in future CIPs:
 - \$5.0 million for Alewife Brook Pump Station upgrades design and construction;
 - \$10.0 million to complete Cottage Farm Pumped CSO upgrades design and construction;
 - \$6.0 million to complete Hayes Pump Station upgrades design and construction;
 - \$5.0 million to complete Hingham Pump Station upgrades design and construction;
 - \$10.0 million to complete Prison Point Pump Station and Pumped CSO Facility upgrades design and construction;
 - \$3.0 million to complete Somerville Marginal Gravity CSO Facility upgrades design and construction;
 - \$60.0 million for long-term annual asset protection program for equipment rehabilitation/replacement at all pump stations and CSO facilities, budget based on \$2.0 million per year for 30 years; and,
 - \$100.0 million as a placeholder for future pump station and CSO facility condition assessment and upgrades (plan, design and construct) for 10 newer wastewater pump station and CSO facilities;

10.02 Facilities Overview

The MWRA wastewater collection system includes 13 pump stations, one screening facility, and six CSO treatment/storage facilities. Key information on each pump station and CSO facility is provided in Table 10-1. The location of each facility is shown on Figure 10-1 and the service area tributary to each pump station is shown on Figure 10-2.

Management of pump stations and CSO facilities is the responsibility of the Wastewater Operations and Maintenance Department, which is a subset of the Operations Division under the oversight of the Chief Operating Officer and one of the Deputy Chief Operating Officers. Key supervisory staff reporting to the Director, Wastewater Operations and Maintenance Department include: Manager, Operations and Manager, Maintenance.

TABLE 10-1

MWRA Pump Stations and CSO Facilities				
Facility/Location	Average Daily Flow (MGD)	Peak Capacity (MGD)	Year Built (Original)	Flow Received From
Alewife Brook Pump Station Somerville	9.8	75	1951	Alewife Brook Sewer & Conduit, Belmont & Lexington Branch Sewers
BOS019 CSO Storage Conduit	N/A	N/A	2007	Charlestown Branch Sewer
Braintree/Weymouth Replacement Pump Station Quincy	8.5	28	2007 (1937)	Braintree-Weymouth Interceptor
Caruso Pump Station East Boston	18	80-125	1991	Chelsea Branch Sewer Relief and East Boston Branch Sewer Relief and BWSC East Boston Low Level Sewer
Chelsea Screen House Chelsea	12	32	1990	Chelsea Branch Sewer Relief
Cottage Farm Pumped CSO Facility Cambridge	N/A	233	1971	North and South Charles Relief Sewers
DeLauri Pump Station Charlestown	31	93	1993	Cambridge Branch Sewer
Framingham Pump Station Framingham	N/A	28	1998	Ashland & Framingham Local Sewers
Hayes Pump Station Wakefield	3	9	1987 (1921)	Reading Extension Relief Sewer and Wakefield Local Sewers
Hingham Pump Station Hingham	3.5	7	1992 (1957)	Hingham Local Sewers
Hough's Neck Pump Station Quincy	0.5	1.3	1999 (1942)	Quincy Local Sewers
Intermediate Pump Station (IPS) North Weymouth	14.8	45	2005	North Weymouth Relief Interceptor
New Neponset Valley Sewer Pump Station Canton	N/A	46	1995	New Neponset Valley Sewer
North Dorchester Bay CSO Storage and Pump Facilities	N/A	N/A	2011	South Boston Local Combined Sewers
Prison Point Pump Station and Pumped CSO Facility Cambridge	PS - 2.5 CSO - N/A	PS - 5 CSO - 323	1980	Cambridge Marginal Conduit, Boston Marginal Conduit, CSO from Charlestown Branch Sewer
Quincy Pump Station Quincy	6	22	2002 (1908)	Quincy Local Sewers
Somerville Marginal Gravity CSO Facility Somerville	N/A	145	1971	Somerville-Medford Branch Sewer and Somerville Local Combined Sewers
Squantum Pump Station Quincy	1.2	7.5	2003 (1930)	Quincy Local Sewers
Union Park CSO Facility South End, Boston	N/A	300 (BWSC PS)	2006	South End Local Combined Sewers
Wiggins-Castle Island Terminal Pump Station South Boston	0.1	0.5	1960	Castle Island and Connolly Terminal Sewers

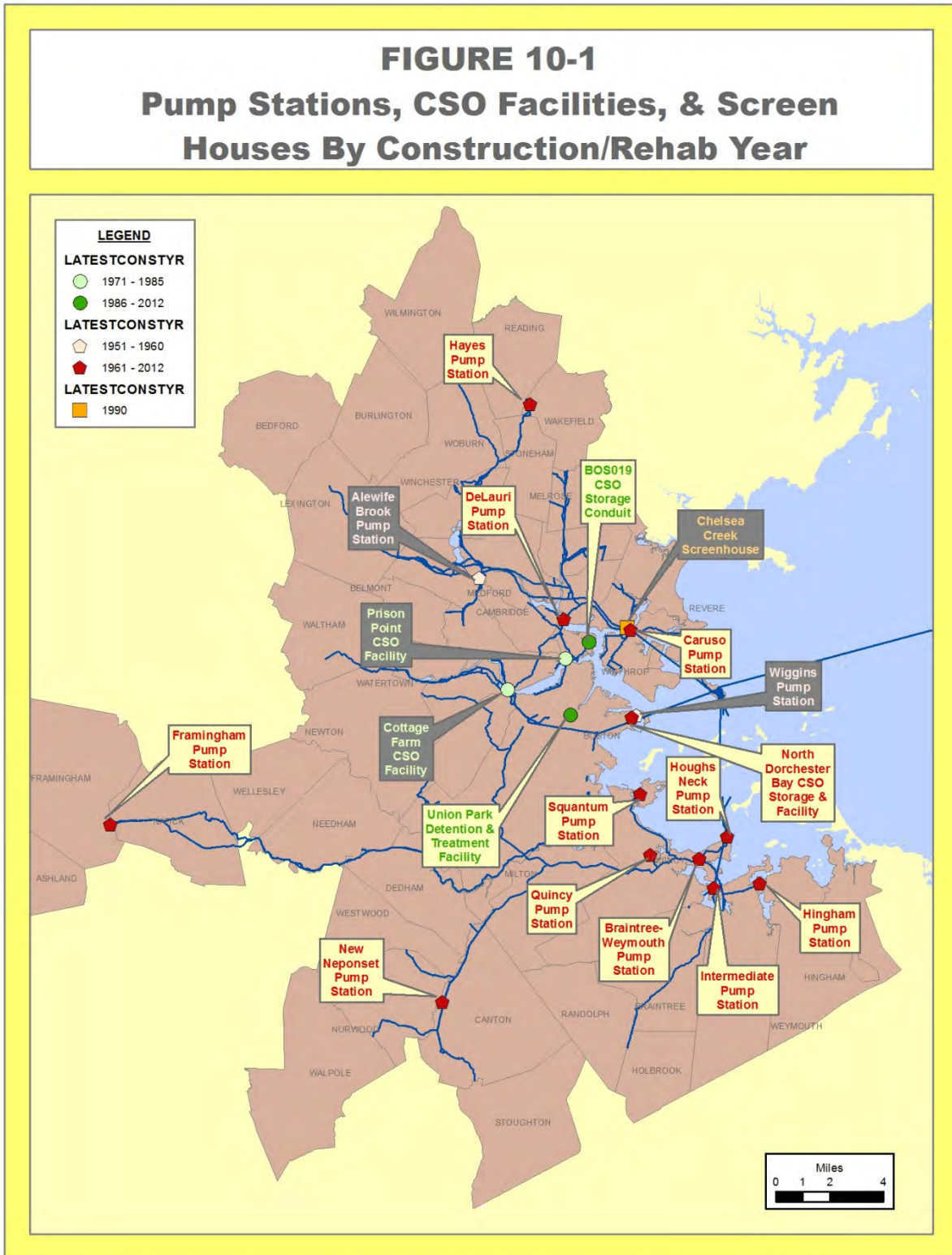

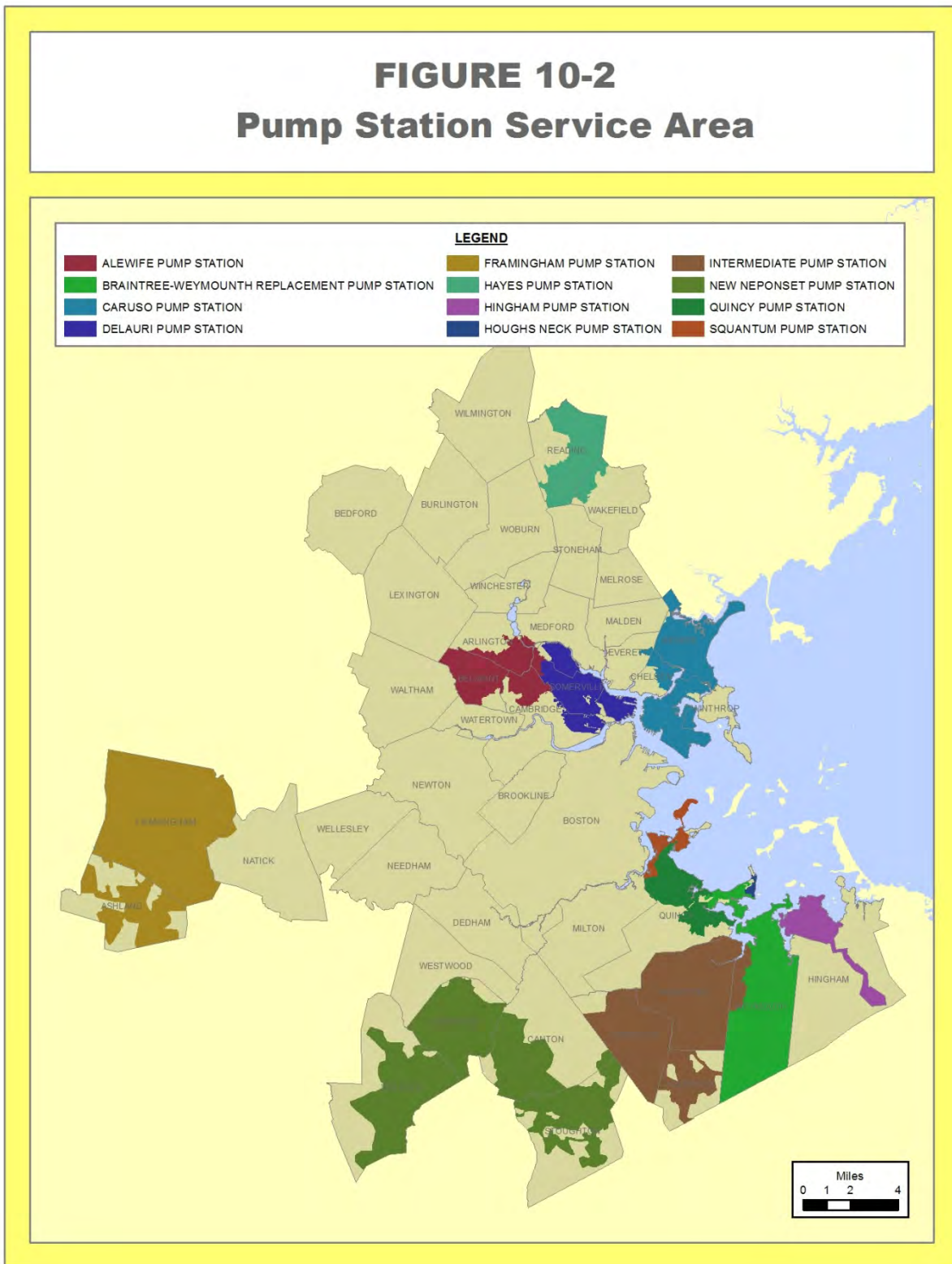

Operation and Maintenance: There is no dedicated staff at any MWRA pump station or CSO facility. A total of about 40 staff are employed in roving crews for operation and maintenance. Operations data are scanned via mini-computer at facilities and downloaded to a central computer. All system scans that produce abnormal readings are checked by area supervisors. Facility Maintenance and Equipment Maintenance are two consolidated programs made up of the mechanic specialists, machinists, metalworkers, welders, plumbers, HVAC specialists, electricians, building and grounds workers, and facility specialists (carpenters and painters). These groups (total of about 89 staff) perform maintenance activities at both wastewater and water facilities. Work Coordination in the Operations and Maintenance Department provides scheduling and job planning at all wastewater facilities. All maintenance is scheduled through the MAXIMO system (see detail below).

All facility operation staff report to the Chelsea Operation Control Center (OCC) at the beginning of each shift to receive assignments. The OCC is manned continually with an Area Supervisor. There are four shifts for Wastewater Operations: 7AM-3PM; 3PM-11PM; 11PM-7AM; and a relief shift. MWRA's wastewater system facilities are split into four geographic operational areas: Area A includes BOS 019 CSO Storage Conduit, Cottage Farm Pumped CSO Facility, Prison Point PS and Pumped CSO Facility, and Somerville Marginal Gravity CSO Facility; Area B includes Braintree/Weymouth Replacement PS, Framingham PS, Hough's Neck PS, and New Neponset Valley Sewer PS; Area C includes Alewife Brook PS, Caruso PS, Chelsea Screen House, DeLauri PS, and Hayes PS; and Area D includes Hingham PS, IPS, North Dorchester Bay CSO Storage and Pump Facilities, Quincy PS, and Squantum PS. Teams of operations staff rove through facilities within the four Areas and electronically collect operational and utility data. Staff also answer alarms and receive deliveries. The OCC contains facility SCADA screens and, from the OCC, staff can remotely control and adjust facility operation. A description of SCADA is provided in Chapter 12. The Wiggins-Castle Island Terminal PS is not included within the four operational areas. This station is checked once per month by operations staff.

The Union Park CSO Facility, located in Boston's South End, is operated through a jointly managed and paid for operations contract between BWSC and MWRA. The cost of this operations contract is mostly covered by BWSC (73 percent) given the inclusion of nine other small BWSC-owned pump stations in the contract. The current 3-year contract began in February 2012. At the end of the contract (February 2015), MWRA and BWSC have the option to extend the contract for up to two additional years. MWRA staff review and approve contractor invoices, review reports used for regulatory reporting purposes, and monitor the contractor's performance.

A standard operating procedure (SOP) has been developed specific to each MWRA pump station and CSO facility and contains information on facility operation and maintenance procedures. Some facilities have detailed operation and maintenance manuals that were developed during facility start-up. In addition, operation and maintenance manuals are generally furnished by the manufacturer of each piece of major equipment (pumps, generators, bar screens, etc.). MWRA staff should periodically review/update SOPs for all facilities.

Need for CSO Facilities: Five MWRA member community wastewater collection systems were originally constructed using combined sewers (designed to receive both sanitary flow and stormwater), including portions of Boston, Brookline, Cambridge, Chelsea, and Somerville.

During larger storm events, flows may increase beyond the conveyance capacities of local sewers, local connections to MWRA's system or MWRA interceptors. Under these conditions, excess flow can be released to nearby receiving waters. At these locations, collection system relief is needed to mitigate system flooding, backups into basements, and upstream overflows. The release is called a combined sewer overflow (CSO). CSO facilities are designed to treat these overflows by screening out debris (for floatables control), in some cases removing settleable solid using settling/detention basins, providing disinfection to destroy pathogens, and dechlorination of the flow before it enters the receiving water. The Somerville Marginal CSO facility is the only gravity CSO facilities still in service. It is designed for unattended, automatic start-up when wastewater flow reaches a preset level. There are two pumped CSO facilities: Prison Point and Cottage Farm. Both facilities can be remotely activated from the OCC during a wet weather event. If staffing allows, CSO facilities are often manned during activations. Also, given the need to take grab samples to adjust chemical dosage, staff typically are staged at CSO facilities when a storm event is expected to result in facility activation. The MWRA also owns and operates two storage and pump back facilities: BOS019 (Little Mystic Channel) CSO Storage Conduit and North Dorchester Bay CSO Storage and Pumped CSO Facility. Both storage facilities are designed to permit automatic filling and dewatering of the storage facilities.

Facility Operation: Influent gates at pump stations and CSO facilities allow flow to enter the facility, restrict flow into the facility, and isolate the facility from system flow when necessary. Bar screens remove large debris to protect pumping equipment and/or remove the debris from a CSO discharge. At some stations, screenings are ground and returned to the flow downstream of the bar screen or channel grinders are used within the facility's influent channels. Electric or diesel driven pumps maintain the wet well level between target maximum and minimum elevations. Pumps have either a single speed motor or a variable frequency drive to increase or decrease the pump rate. The pumps discharge into a force main that generally connects to a downstream gravity sewer or (for CSO Facilities) discharge to a receiving water. A check valve and manually operated gate valve is generally installed on the discharge pipe from each pump to prevent backflow and allow the pump to be isolated for maintenance. Electric service is provided to most facilities via local commercial service. Most facilities have on-site backup generators for emergency power, or in some cases a portable generator can be transported to the site, as needed. Most facilities also have some form of wastewater flow metering.

Facility Maintenance: A primary focus of operation and maintenance staff is preventive maintenance. Tasks performed by operational staff are generally defined as light maintenance duties that increase the number of maintenance staff work hours dedicated to maintenance activities. This information is captured in MWRA's MAXIMO work order system. The MAXIMO computerized maintenance management system records all work activities and work order requests from operations and maintenance personnel. This system gives management the ability to track maintenance needs, prioritize work orders, and generate reports of open and closed work activities. Reports can be generated and information retrieved about equipment condition. Abnormal conditions are noted and forwarded to planner/schedulers for work order processing and further action by the Equipment Maintenance Section. Backlog levels depend on available resources and are generally in the range of four to six weeks, but daily coordination ensures that primary and critical equipment is functioning at adequate levels at all times. Work is prioritized, with critical equipment receiving the most attention.

MWRA In-House Tasks: The following ongoing in-house tasks related to the pump station and CSO facilities has been performed by MWRA staff:

- Alewife Pump Station: New screen parts have been purchased and screens #1 and #2 have been rehabilitated. A new air handling unit was installed in the upper motor area to provide cooling to the variable frequency drives.
- Braintree Weymouth Pump Station: All three pumps were rebuilt a spare pump was purchased. One muffin monster was replaced and a spare purchased.
- Caruso Pump Station: Three large pumps were rebuilt with mechanical seals. One screen conveyor carriage assembly was replaced in 2010/11. The secondary main breaker was replaced in 2012.
- Chelsea Screen House: The carriage assemblies were rebuilt in 2012 as a short-term fix and two new carriage assemblies and tracks were purchased and installed.
- Cottage Farm Facility: The three diesel driven pump gearboxes were rebuilt (by the manufacturer), the two river water flushing pumps, new weirs, a new air handling unit and a new valve with electric actuator were installed.
- Delauri Pump Station: Both screens were rehabilitated in 2010/11 with new rakes, chains, gearboxes, and motors.
- Framingham Pump Station: Pumps #1 and #3 were removed and rebuilt with new mechanical seals in 2012/13.
- Hayes Pump Station: Pump #2 was rebuilt, the surge valve replaced, and the screen carriage assembly has been replaced.
- Intermediate Pump Station: The conveyor rollers, grease system, and belts were replaced.
- New Neponset Pump Station: Three gearboxes and shafting were rebuilt.
- Prison Point CSO Facility: The storage tank washdown piping and supports, secondary main breaker, main distribution panel, and distribution panelboard were replaced and the dry weather screen was rebuilt.

There are four additional in-house tasks related to pump station and CSO facilities recommended to be completed by MWRA staff:

- Staff should review/update SOPs, as needed, for all facilities.
- Staff should update the 2002 Equipment and Operational Summary for Wastewater Transport Facilities.
- MWRA should continue to work with Town of Braintree personnel to finalize a successor Agreement to the 1990 Agreement regarding MWRA's use of Braintree's Howard Street Pump Station. The agreement should be approved by MWRA's Board of Directors. An annual bill should be assessed from Braintree to MWRA and an annual payment should be made by MWRA to Braintree.
- Staff should implement an in-house task to evaluate/assess all decommissioned facilities and all facilities that may have historical significance. A prioritized list of action items and schedule required for facility reuse study, coordination with Massachusetts Historical Commission, coordination for surplus to DCAM, etc. should be developed. This project may require use of as-needed consultants.

Service Contracts: The in-house CEB maintenance program is supplemented by a series of service contracts, as listed below:

- Architectural, electrical, HVAC, and mechanical engineering design;
- Boiler and water heater service maintenance;
- Compressed air maintenance;
- Crane maintenance;
- Diesel generator maintenance;
- Elevator maintenance;
- High voltage maintenance;
- Hydraulic Equipment maintenance;
- Instrumentation maintenance;
- Fire & Fire Sprinkler System maintenance; and,
- Overhead door maintenance.

Facility Emergency Response: Operation of all collection system Facilities is monitored via the MWRA SCADA system at the Chelsea OCC. Any operational problems at the facilities are identified by Area Supervisors in the OCC. If emergency response is needed, maintenance crews are dispatched. All pump station facilities are equipped with back-up power via a diesel generator, except for BOS019 CSO Storage Conduit, North Dorchester Bay CSO Storage and Pump Facilities, and the Wiggins – Castle Island Terminal Pump Station. Prolonged operational problems at pump stations and CSO facilities could potentially result in upstream sewer surcharging. A project to review the emergency response plan and the hydraulics associated with sewer surcharging that may be caused by prolonged facility downtime is recommended for consideration in a future CIP at an estimated cost of \$500,000 during FY21-23. Staff recommend an engineering consultant be procured to review wastewater facilities and perform hydraulic modeling to determine the impact of prolonged operations problems (facility downtime, reduced pumping, loss of screens, etc). The analysis would identify critical upstream SSO or back-up locations and elevations and the duration of reduced facility capacity that may result in an SSO at various (higher and lower) wastewater flow rates. Projects that may provide emergency system relief to minimize a diminished level of sewer service would be recommended.

Facility Vulnerability to Severe Weather: After Super Storm Sandy in October 2012, staff began an evaluation of the vulnerability of MWRA water and wastewater systems to more extreme weather, adopting a benchmark of the current 100 year flood elevation plus an additional 2.5 feet to account for sea level rise and more severe storms, as is in use by other agencies. The analysis identified a number of coastal wastewater and administrative facilities which are either vulnerable to the current 100 year storm event or the more conservative benchmark. The “Report on Severe Weather Preparedness for MWRA Coastal Facilities” was presented as a Staff Summary at the October 16, 2013 Board of Directors meeting (see details in that report). Six wastewater facilities were identified as having a “High Risk” (likely affected by a 100 year flood): Chelsea Screen House, Braintree/Weymouth Replacement PS, North Dorchester Bay CSO Storage Tunnel Ventilation Building, Squantum PS, Residuals Pellet Plant, and the Chelsea Creek Headworks. The first four of these facilities are detailed in this chapter, the Residuals Pellet Plant is detailed in chapter 7 and the Chelsea Creek Headworks is detailed in chapter 8.

10.03 Alewife Brook Pump Station

- Address: 392 Alewife Brook Parkway, Somerville
- Location Map: See Figure 10-1
- Tributary Area Map: See Figure 10-2
- Average Daily Flow: 9.8 mgd
- Peak Capacity: 75 mgd

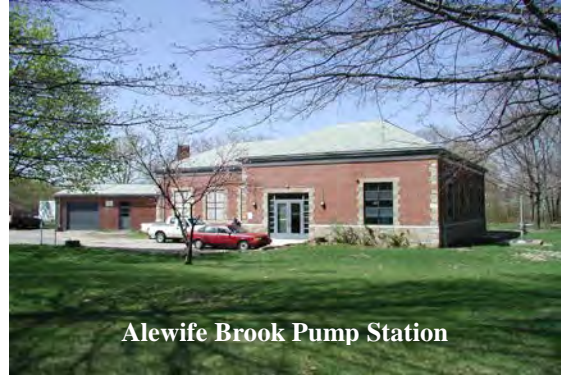

Alewife Brook Pump Station

Facility Function and Operation: The Alewife Brook Pump Station was built in 1951. This facility lifts wastewater from four upstream MWRA sewers: Alewife Brook Conduit, Alewife Brook Sewer, Belmont Branch Sewer, and Lexington Branch Sewer. Pumped flow is discharged to the downstream North Metropolitan Trunk Sewer and North Metropolitan Relief Sewer so that gravity flow can continue to the Chelsea Creek Headworks. The tributary area includes parts of Arlington, Belmont, Cambridge, Somerville and a small portion of Medford. The tributary area includes both combined and separate sewers. Continued sewer separation in Somerville and Cambridge should reduce the amount of storm water currently tributary to this pump station.

The first significant rehabilitation of this station was upgrade of the pump motors and gearboxes and installation of variable frequency drives (VFDs) on pump 2, 3, and 4. This work was accomplished under Contract 5302 in 1992. The second upgrade was the replacement of the mechanical bar screen system, update of the HVAC system, and replacement of the facility's windows and doors under contract 5330, all completed in 1996. A third facility upgrade was the replacement of the transformer station, completed in 2001. A fourth upgrade was completed in 2008, with the addition of a VFD to Pump 1, replacement of VFDs on Pumps 2 and 3, and installation of a new 15 MGD pump, pump motor, and VFD for Pump 4, and SCADA instrumentation.

Facility Components: Major facility components include: two influent electric sluice gates, two influent manual sluice gates, two mechanical bar screens, two screenings grinders, four pumps (three at 26 mgd and one at 15 mgd), four electric motors, two electric sluice gates (downstream of the bar screens), redundant wet well ultrasonic depth meters, effluent flow meters and an electric sluice gate at the connection of the wet weather discharge chamber and Alewife Brook Conduit.

Hydraulic Performance: Under certain peak flow conditions, the downstream hydraulic gradeline can limit the peak flow that can be pumped by the facility. During a storm event, it is important for the operators of the facility to monitor the water surface in the discharge chamber outside of the pump station, to assure that excessive pumping against the downstream hydraulic grade line does not cause flooding of the discharge chamber. During significant storm events that cause influent flow to exceed the facility's pumping capacity and/or the downstream interceptor system capacity, CSO regulators along the upstream sewer and/or within tributary community connections can discharge to Alewife Brook. MWRA's CSO Control Plan addresses these CSO discharges (see Chapter 11).

Facility Power: The primary electrical feed is from commercial service via Gordon Street in Somerville. A secondary commercial electrical feed serves the station from Decatur Street in Arlington. When primary power fails, power is automatically transferred from the primary to the secondary source. The commercial power company must be contacted to switch back to the primary power source. A diesel generator (600 kW) provides backup power.

Standard Operating Procedures (SOPs): The Station SOP was developed in 1992 and updated in 2002.

Force Main: The three 26 MGD pumps discharge to Section 176A, a 66-inch diameter reinforced concrete force main, 670 feet long, built in 1948. The No. 4 15 MGD pump discharges to Section 155, a 24-inch diameter cast iron force main, 168 feet long, built in 1948.

Record Drawings: Accession Numbers 200260 to 200272, 52452, 200440 to 200465, 603437, 512555, 512595 to 512597, 512642 to 512645, and 519822 to 519850.

Condition Assessment and Recent Upgrades: The Alewife Brook Pump Station (1951) is the oldest of the 20 MWRA wastewater facilities reviewed in this Chapter. The station is in fair condition with the most urgent equipment upgrades being addressed in the Alewife Brook Pump Station Rehabilitation design and construction project that began in FY10. The final preliminary design report, completed in 2011, is the basis for the ongoing rehabilitation design and construction project that will be complete in FY18.

Projects in the Existing FY14 CIP:

- Alewife Brook Pump Station Rehabilitation design and construction project is ongoing and programmed in the FY14 CIP (within the Interceptor and Pumping Facility Asset Protection Project) at a total remaining cost of \$9.926 million during FY14-18. The preliminary design report was completed in FY11. The final design and construction (including construction administration and resident inspection services) began in FY12 and is scheduled to be completed in FY18. The upgrade will include replacing the three larger station pumps, motors, and piping (adding pump redundancy and increasing pump reliability/efficiency); replacing climber screens and grinders; updating the HVAC system; updating the electrical system; and modifying the building interior. The fourth pump (smallest of the four pumps) was previously replaced under the SCADA Project.
- The Alewife Brook Pump Station is included in the Pump Station and CSO Condition Assessment for 10 Older Facilities project that is programmed in the FY14 CIP at a cost of \$3.0 million in FY15-17. This project will provide professional engineering services (via an RFQ/P process) including design review, inventory, evaluation, identification and prioritization of rehabilitation/replacement projects and operational processes for MWRA's ten older pump stations and CSO facilities. The ten older pump station and CSO facilities to be included in the condition assessment project are: Alewife Brook, Caruso, Chelsea Screen House, DeLauri, Hayes, Hingham, Prison Point, Wiggins - Castle Island Terminal, Cottage Farm, and Somerville Marginal. The consultant will review the adequacy of existing components and processes and provide recommendations based upon the latest/alternative technology. Information developed by this project will be used by MWRA to produce a list of recommended design/construction upgrade projects by facility, priority, and fiscal year. Since significant upgrades to the Alewife Brook Pump

Station are ongoing, it is assumed that any additional recommended upgrades will be low priority for scheduling compared to upgrade projects recommended for other facilities.



Pump



Motor

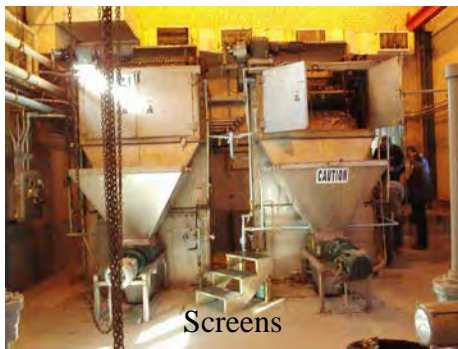

Screens

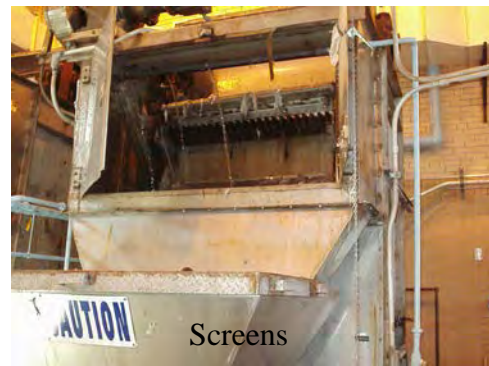

Screens

Projects Recommended for Consideration in Future CIPs:

- Alewife Brook Pump Station Upgrades design and construction is recommended for consideration in future CIPs at an estimated cost of \$5.0 million during FY31-35. Upgrades to be designed and constructed under this project will be identified in the Condition Assessment Project for 10 Older Facilities.

10.04 BOS019 CSO Storage Conduit

- Address: Corner of Medford Street & Chelsea Street, Charlestown
- Location Map: See Figure 10-1
- Average Daily Flow: N/A – only operated during peak (wet weather) flow
- Maximum Storage Capacity: 670,000 gallons



Facility Function and Operation: The BOS019 CSO Storage Conduit was built in 2007 at the corner of Chelsea Street and Medford Street (under the Tobin Bridge) in the Charlestown neighborhood of Boston at a construction cost of \$14.3 million. The facility includes two, 280-foot long, 10-foot by 17-foot underground concrete

conduits that provide 670,000 gallons of overflow storage capacity, as well as an above ground pump-out facility and an underground influent gatehouse. The project is predicted to reduce the average annual number of CSO discharges from outfall BOS019 to the Little Mystic Channel from 13 to 2, and reduce total annual discharge volume at this outfall by 86 percent, from 4.4 million gallons to 0.6 million gallons. The stored flows are pumped back to the interceptor system (Charlestown Branch Sewer) for conveyance to Deer Island after each storm passes and system capacity becomes available. An aboveground building houses the dewatering equipment, as well as the activated carbon odor control systems for treating air that is displaced when the conduit fills with combined sewage. During larger storms that cause overflows that exceed the storage volume of the conduit, system relief will continue to be provided through CSO outfall BOS019. For this reason, underflow baffles were installed within the existing and proposed regulator as part of this project to provide floatables control.

Facility Components: Major facility components include: 36-inch by 36-inch influent electric sluice gate; twin 6000 gallon flushing chambers each with a 70-inch by 16-inch flushing gate; two 280-foot long, 10x17-foot concrete box conduits to provide 670,000 gallons of off-line storage; activated carbon odor control system; and two 800 gpm dewatering pumps.

Hydraulic Performance: Activation of the BOS019 CSO Storage Conduit during storm events is controlled by a weir upstream of the influent gate. If the hydraulic grade line elevation in the MWRA Charlestown Branch Sewer (Section 32) exceeds the weir elevation, wastewater enters the influent chamber, which automatically opens the influent sluice gate. If the facility capacity is exceeded, the influent gate closes causing the hydraulic grade line in the influent chamber to exceed a second weir. Wastewater overtopping the second weir discharges to the Little Mystic River at outfall BOS019.

Facility Power: The primary electrical feed is from local commercial service. Quick connects are provided for hook-up to a back-up diesel generator that would be transported to the facility.

Standard Operating Procedures (SOPs): The Station SOP was developed in 2007.

Record Drawings: Accession Numbers 225830 to 225932.

Condition Assessment and Recent Upgrades: The BOS019 CSO Storage Conduit is relatively new and in excellent condition. No immediate upgrades are anticipated.

Projects Recommended for Consideration in Future CIPs:

- The BOS019 CSO Storage Conduit is included in the Future Pump Station and CSO Facility Condition Assessment and Upgrades for 10 Newer Facilities project that is recommended for consideration in future CIPs. This project has a placeholder budget estimate of \$100.0 million to assess equipment replacement and upgrades (including planning, design, and construction) during the FY34-53 timeframe. The 10 newer wastewater pump station and CSO facilities include: BOS019 CSO Storage Conduit, Braintree/Weymouth Replacement PS, Framingham PS, Hough's Neck PS, Intermediate PS, New Neponset Valley Sewer PS, North Dorchester Bay CSO Storage and Pump Facility, Quincy PS, Squantum PS, and Union Park CSO Facility.

10.05 Braintree/Weymouth Replacement Pump Station

- Address: 27 Kilby Street, Quincy, MA
- Location Map: See Figure 10-1
- Tributary Area Map: See Figure 10-2
- Average Daily Flow: 8.5 mgd
- Peak Capacity: 28 mgd



Facility Function and Operation: The Braintree/Weymouth Replacement Pump Station was completed in 2007. This facility replaced the original Braintree/Weymouth Pump Station built in 1937. The pump station lifts wastewater from the upstream Braintree-Weymouth Interceptor and a local Quincy sewer into the High Level Sewer so that gravity flow can continue to the Nut Island Headworks. The tributary area includes the Adams Shore and Germantown portions of Quincy, the majority of Weymouth, and all of Hingham (via the Hingham Pump Station). The entire tributary area consists of separate sanitary sewers. Wastewater flow tributary to the Intermediate Pump Station (IPS) (under normal operating conditions) can be diverted to flow to the Braintree/Weymouth Replacement Pump Station. Similarly, a portion of the wastewater flow tributary to the Braintree/Weymouth Replacement Pump Station (under normal operating conditions) can be diverted to flow to the IPS.

Facility Components: Major facility components include: two hydraulic influent sluice gates, two screenings grinders, three raw wastewater pumps, effluent flow meter, activated carbon odor control system, emergency generator and a lightning protection system. The pump station houses an office, lunch room, locker rooms, radio room, electrical room, generator room, boiler room, pump access room, and odor control room on the first floor level. The lower level houses a valve room with storage area, two wetwells, channels with screenings grinders, influent junction chamber and gates. The attic houses a mechanical area for HVAC equipment. All major areas of the facility contain fire protection sprinklers and internal/external antennas for radio communication.

Hydraulic Performance: No problems. During extreme rainfall events that cause peak flows, the backup pump may be operated to increase the peak pumping capacity from about 28 mgd to about 35 mgd.

Facility Power: The primary electrical power is from local commercial service. A diesel generator (750 kW) provides backup power.

Standard Operating Procedures (SOPs): A facility handbook with SOPs was completed in March 2008.

Force Main: Section 622, 36-inch diameter ductile iron pipe, 34 feet long, constructed in 2007.

Record Drawings: Accession Numbers 202591 to 202599, 202604 to 202670, 229118 to 229128, and 603155 to 603194.

Condition Assessment and Recent Upgrades: The Braintree/Weymouth Replacement Pump Station was completed in 2007 and is in very good condition. However, some facility issues have surfaced after the first 5 year of operations. Facility improvements are recommended to modify the means of getting the large submersible pumps out of the wetwell and odor control improvements are proposed in the grinder room.

Projects Recommended for Consideration in Future CIPs:

- The Braintree/Weymouth Replacement Pump Station is included in the Future Pump Station and CSO Facility Condition Assessment and Upgrades for 10 Newer Facilities project that is recommended for consideration in future CIPs. This project has a placeholder budget estimate of \$100.0 million to assess equipment replacement and upgrades (including planning, design, and construction) during the FY34-53 timeframe. The 10 newer wastewater pump station and CSO facilities include: BOS019 CSO Storage Conduit, Braintree/Weymouth Replacement PS, Framingham PS, Hough's Neck PS, Intermediate PS, New Neponset Valley Sewer PS, North Dorchester Bay CSO Storage and Pump Facility, Quincy PS, Squantum PS, and Union Park CSO Facility.

10.06 Caruso Pump Station

- Address: 601 Chelsea Street, East Boston
- Location Map: See Figure 10-1
- Tributary Area Map: See Figure 10-2
- Average Daily Flow: 18 mgd
Peak Capacity: Typically 90 mgd, however, design capacity is 125 mgd. Flow at the Caruso Pump Station is restricted by the downstream capacity at the Winthrop Terminal Facility.



Facility Function and Operation: The Caruso Pump Station was built in 1991. The facility lifts wastewater to the North Metropolitan Trunk Sewer which is tributary to the Winthrop Terminal Facility at the Deer Island Treatment Plant. The tributary area includes both combined and separate flow from portions of Chelsea, East Boston, and Everett, and all of Revere. The pump station receives flow from the East Boston Branch Sewer Relief and BWSC's East Boston Low Level Sewer. The pump station also receives flow from the Chelsea Branch Sewer Relief and the Revere Extension Sewer via the Chelsea Screen House and Dry Weather Siphon (this is normal operation). In addition, the station is designed to receive overflow from the Chelsea Creek Headworks via the Wet Weather Siphon (this is an exception to normal operation). There is operational flexibility depending on dry weather/wet weather (average flow/peak flow) conditions at the Caruso Pump Station and connecting sewers to the Chelsea Screen House and Chelsea Creek Headworks. Various gates can be operated to adjust the flow distribution.

Facility Components: Major facility components include: four 21 mgd dry weather pumps, three 50 mgd wet weather pumps, two influent electric sluice gates, two wet well influent electric sluice gates, two influent channel manual roller gates, two mechanical bar screens, and venturi meters for all dry and wet weather pumps.

Hydraulic Performance: Peak (wet weather) flow at the Caruso Pump Station is restricted by the downstream capacity of the Winthrop Terminal Facility. The design capacity of the facility is 125 mgd but typical peak flows are limited to 90 mgd. During wet weather operations, a combination of the smaller pumps (21 mgd) and larger pumps (50 mgd) can be used. Flow during most storm events is pumped using the 21 mgd pumps. The facility is typically run automatically. As flows increase additional 21 mgd pumps are automatically brought on-line at successively higher wet well elevations. If the capacity of the 21 mgd pumps is exceeded and the wet well elevation climbs further, a 50 mgd pump is automatically brought on-line to manage flows.

Facility Power: The primary electrical power is from local commercial service. A diesel generator (800 kW) provides backup power.

Standard Operating Procedures (SOPs): An O&M manual was prepared in 1991.

Force Main: The facility's pumps discharge via internal station piping into an effluent channel (force main) Sewer Section 223, an 84-inch diameter reinforced concrete pipe, 227 feet long, constructed in 1985. Sewer Section 223 connects to downstream Sewer Section 009.

Record Drawings: Accession Numbers 201,921 to 201,935 and 227,193 to 227,212.

Condition Assessment and Recent Upgrades: The Caruso Pump Station (1991) is near average age for MWRA facilities and is over 20 years old. The station is in good condition with no major operational problems. Replacement of the station generator and HVAC and fire detection system upgrades are scheduled. It is anticipated that additional equipment may begin to have operational problems since the 20 year useful life span is passed. The station is included in a project to assess equipment replacement and upgrades.

Projects in the Existing FY14 CIP:

- Caruso Pump Station Improvements for generator replacement and HVAC and fire detection system upgrades design and construction project is programmed in the FY14 CIP (within the Interceptor and Pumping Facility Asset Protection Project) at a remaining cost of \$2.916 million in FY14-16. This project began in FY13.
- The Caruso Pump Station is included in the Pump Station and CSO Condition Assessment for 10 Older Facilities project that is programmed in the FY14 CIP at a cost of \$3.0 million in FY15-17. This project will provide professional engineering services (via an RFQ/P process) including design review, inventory, evaluation, identification and prioritization of rehabilitation/replacement projects and operational processes for MWRA's ten older pump stations and CSO facilities. The ten older pump station and CSO facilities to be included in the condition assessment project are: Alewife Brook, Caruso, Chelsea Screen House, DeLauri, Hayes, Hingham, Prison Point, Wiggins - Castle Island Terminal, Cottage Farm, and Somerville Marginal. The consultant will review the adequacy of existing components and processes and provide recommendations based upon the latest/alternative technology. Information developed by this project will be used by MWRA to produce a list of recommended design/construction upgrade projects by facility, priority, and fiscal year.

- Pump Station and CSOs Rehabilitation Preliminary Design/Study for 6 of 10 Older Facilities is programmed in the FY14 CIP at a cost of \$750,000 in FY16-21. This project will provide preliminary design services (via an RFQ/P process) for six of the ten older pump stations and CSO facilities (Caruso, DeLauri, Hayes, Hingham, Wiggins - Castle Island Terminal, and Somerville Marginal).

Projects Recommended for Consideration in Future CIPs:

- Caruso Pump Station Upgrades design and construction is recommended for consideration in future CIPs at an estimated cost of \$25.0 million during the FY19-23 timeframe. Upgrades to be designed/constructed under this project will be identified in the Condition Assessment for 10 Older Facilities project.

10.07 Chelsea Screen House

- Address: 340 Marginal Street, Chelsea
- Location Map: See Figure 10-1
- Average Daily Flow: 12 mgd
- Peak Capacity: 32.0 mgd

Facility Function and Operation: The Chelsea Screen House was built in 1990. The facility screens sewage before it flows to the Chelsea Creek Siphon, which transports sewage to the Caruso Pumping Station. Screening removes large debris that could damage Caruso Station pumps or accumulate and plug the siphon barrels. The facility also provides screening of flows diverted from the Chelsea Creek Headworks during wet weather events. During normal (dry weather) operation, the facility receives flow from the Chelsea Branch Sewer Relief and Revere Extension Sewers, upstream of the Chelsea Creek Siphon. During peak flow (wet weather) operation, if the Chelsea Creek Headwork is above its capacity and the Caruso Pump Station is below its capacity, wastewater can be diverted from the Chelsea Creek Headworks through the Chelsea Screen House for pumping at the Caruso Pump Station.



Facility Components: Major facility components include: seven hydraulic sluice gates and four mechanical bar screens.

Hydraulic Performance: During peak flow conditions, wastewater flow depth within the screen channels can exceed a critical elevation, preventing the screens rakes from operation.

Facility Power: The primary electrical power is from local commercial service. No backup power exists.

Standard Operating Procedures (SOPs): An SOP was prepared in 2011.

Record Drawings: Accession Numbers 9740 to 9783 and 600968 to 600969.

Condition Assessment and Recent Upgrades: The Chelsea Screen House (1990) is near average age for MWRA facilities and is over 20 years old. The station is in good condition; however, operation of the seven hydraulic sluice gates is a concern. Operation and maintenance issues were identified in a preliminary evaluation performed under an as-needed services contract. A concept design report on the mechanical equipment was completed in November 2011 as a task order addition to the Chelsea Creek Headworks Upgrades Design project. It is anticipated that equipment may begin to have operational problems since the 20 year useful life span is passed. The station is included in a project to assess equipment replacement and upgrades.

Projects in the Existing FY14 CIP:

- Chelsea Screen House Upgrades design and construction project including screens and gates is programmed in the FY14 CIP at a cost of \$3.3 million with a project duration of 2 years during the FY15-16 timeframe.
- The Chelsea Screen House is included in the Pump Station and CSO Condition Assessment for 10 Older Facilities project that is programmed in the FY14 CIP at a cost of \$3.0 million in FY15-17. This project will provide professional engineering services (via an RFQ/P process) including design review, inventory, evaluation, identification and prioritization of rehabilitation/replacement projects and operational processes for MWRA's ten older pump stations and CSO facilities. The ten older pump station and CSO facilities to be included in the condition assessment project are: Alewife Brook, Caruso, Chelsea Screen House, DeLauri, Hayes, Hingham, Prison Point, Wiggins - Castle Island Terminal, Cottage Farm, and Somerville Marginal. The consultant will review the adequacy of existing components and processes and provide recommendations based upon the latest/alternative technology. Information developed by this project will be used by MWRA to produce a list of recommended design/construction upgrade projects by facility, priority, and fiscal year.

10.08 Cottage Farm Pumped CSO Facility

- Address: 660 Memorial Drive, Cambridge
- Location Map: See Figure 10-1
- Average Daily Flow: N/A – only operated during peak (wet weather) flow
- Peak Capacity: 233 mgd (limited to 210 mgd by effluent channel and outfall capacity)



Facility Function and Operation: The Cottage Farm Pumped CSO Facility was built in 1971 and a major upgrade of the facility was completed by MWRA in 2001. The Cottage Farm Pumped CSO Facility provides relief for the North and South Charles Relief Sewers, and is the primary upstream relief point when flow is restricted at the Ward Street Headworks. During peak (wet weather) flows, the facility provides screening, sedimentation, and disinfection (chlorination and dechlorination) to CSOs prior to discharge to the Charles River via the Cottage Farm Outfall (permitted outfall MWR201). The Cottage Farm Facility predominantly receives flows from the CSO communities of Cambridge and Boston (Brighton), but is also downstream of the MWRA communities of Belmont, Newton, Waltham, and Watertown. The facility services a tributary

area of both combined and separate sanitary sewers. During a storm event, water levels in the North and South Charles Relief Sewers can exceed the weir elevation in diversion structures adjacent to the facility, and flow into the facility inlet structure. An additional influent line to the facility (Cottage Farm/Brookline Connection) was reconfigured in 2009 (previously this sewer was not in use) to increase hydraulic capacity to the South Charles Relief Sewer on the other side of the Charles River. After chlorination and screening, flows enter a wet well for pumping to the detention tanks. When the volume exceeds the detention tank capacity, flow overtops the detention tank weirs, is dechlorinated, and discharges by gravity to the Charles River through a 96-inch outfall conduit. At the end of a storm, the contents of the detention tanks are drained by gravity back to the North Charles Relief Sewer.

Facility Components: Major facility components include: three inlet structure sluice gates, three coarse and three fine wet weather flow mechanical screens, six 215,000 gallon sedimentation/detention tanks, four wet weather pumps (three 90 mgd diesels and one 35 mgd electric), two stripping pumps, chemical treatment (chlorination and dechlorination) system, and four flow meters.

Hydraulic Performance: Activation of the Cottage Farm Pumped CSO Facility during storm events controls the hydraulic grade line elevations in the upstream North and South Charles Relief Sewers. Without the facility, combined wastewater would surcharge the upstream system and discharge through several upstream untreated CSO outfalls to the Charles River, including: CAM005, CAM007, CAM009, and CAM011. Choking of the Ward Street Headworks contributes to increased overflow at the Cottage Farm Pumped CSO Facility.

Facility Power: The main pumps are powered by three 780 HP diesel engines. One 300 HP electric pump is also available. The primary electrical power is from local commercial service. A diesel generator (80 kW) provides backup power.

Standard Operating Procedures (SOPs): The facility SOP was last updated in 2009.

Force Main: There is no exterior force main. Wastewater is lifted within the Cottage Farm Pumped CSO Facility to detention tanks. The 96-inch diameter outfall is gravity flow to the Charles River. The detention tank drains via gravity flow to the North/South Charles Relief Sewer.

Record Drawings: Accession Numbers 54,813 to 54,886, 203,308 to 203,393, and 601,860 to 601,866.

Condition Assessment and Recent Upgrades: The Cottage Farm Pumped CSO Facility (1971) is 41 years old, twice the average age for MWRA pump station and CSO facilities and is well beyond the 20 year old milestone. In 2001, MWRA completed an upgrade project under the CSO Control Plan (see Chapter 11). The facility upgrades generally included the replacement of the chlorine disinfection system and addition of a dechlorination system, as well as process control and safety improvements. The station remains in fair to good condition, with no major operational problems. It is anticipated that station equipment will begin to have operational problems in the upcoming years. The station is included in a project to assess equipment replacement and upgrades.

Projects in the Existing FY14 CIP:

- The Prison Point and Cottage Farm CSO Rehabilitation Preliminary Design/Study project is programmed in the FY14 CIP at a cost of \$1.0 million in FY15-16. This project will develop a plan to replace/upgrade mechanical, electrical, chemical feed, and instrumentation systems; conversion to electric variable frequency drives; and redundancy concerns at the two stations.
- The Prison Point and Cottage Farm Facilities Upgrade project including generators and Prison Point pump and gear box is programmed in the FY14 CIP at a cost of \$5.099 million in FY14-15.
- The Cottage Farm Fuel System Upgrade project is programmed in the FY14 CIP at a remaining cost of \$26,000 in FY14. This project began in FY13.
- The Cottage Farm Pumped CSO Facility is included in the Pump Station and CSO Condition Assessment for 10 Older Facilities project that is programmed in the FY14 CIP at a cost of \$3.0 million in FY15-17. This project will provide professional engineering services (via an RFQ/P process) including design review, inventory, evaluation, identification and prioritization of rehabilitation/replacement projects and operational processes for MWRA's ten older pump stations and CSO facilities. The ten older pump station and CSO facilities to be included in the condition assessment project are: Alewife Brook, Caruso, Chelsea Screen House, DeLauri, Hayes, Hingham, Prison Point, Wiggins - Castle Island Terminal, Cottage Farm, and Somerville Marginal. The consultant will review the adequacy of existing components and processes and provide recommendations based upon the latest/alternative technology. Information developed by this project will be used by MWRA to produce a list of recommended design/construction upgrade projects by facility, priority, and fiscal year.

Projects Recommended for Consideration in Future CIPs:

- Cottage Farm Pumped CSO Facility Upgrades design and construction is recommended for consideration in future CIPs at an estimated cost of \$20.0 million during the FY19-28 timeframe. Upgrades to be designed/constructed under this project will be identified in the Condition Assessment for 10 Older Facilities project.

10.09 DeLauri Pump Station

- Address: 172 Alford Street, Charlestown
- Location Map: See Figure 10-1
- Tributary Area Map: See Figure 10-2
- Average Daily Flow: 31 mgd
- Peak Capacity: 93 mgd

**DeLauri Pump Station**

Facility Function and Operation: The DeLauri Pump Station was built in 1993. The facility lifts wastewater to the Cambridge Branch Sewer, which is tributary to the North Metropolitan Sewer and transports flow to the Chelsea Creek Headworks. The facility receives flow from the Cambridge Branch Sewer, which intercepts flow from the Charlestown Branch and Somerville/Medford Branch Sewers as well as local community sewer systems. The tributary area includes both combined and separate flow from portions of Charlestown, Somerville, Cambridge and Medford, including flow from the dry weather pump station at the Prison Point

Pump Station and Pumped CSO Facility. The substantial amount of combined area tributary to the facility results in rapid increases in flow during rainfall events.

Facility Components: Major facility components include: three 46.5 mgd pumps, four screen channel motorized sluice gates, three motorized knife suction gates, three motorized knife pump discharge gates, two automatic bar screen, one venturi meter, activated carbon odor control system and ultrasonic depth meters to monitor the screen channels and wet well.

Hydraulic Performance: The influent line to the facility is a single barrel 60-inch diameter siphon that limits peak flow to the facility. During wet weather events that exceed the station's capacity, surcharging in the upstream Cambridge Branch Sewer may increase the hydraulic grade line in the upstream community-owned sewers and cause overflows to the Prison Point Pump Station and Pumped CSO Facility. As an outcome of the Wastewater Process Optimization Study, further evaluation of the benefits of constructing a redundant siphon crossing the Mystic River from the Cambridge Branch Sewer to the DeLauri Pump Station was recommended (see Chapter 9).

Facility Power: The primary electrical power is from local commercial service. A diesel generator (600 kW) provides backup power.

Standard Operating Procedures (SOPs): An O&M manual was prepared in 1993.

Force Main: Section 25, is a 60-inch diameter poured-in-place concrete force main, 285 feet long, built in 1989.

Record Plans: Accession Numbers: 9,785 to 9,844.

Condition Assessment and Recent Upgrades: The DeLauri Pump Station (1993) is 19 years old (about average age for MWRA wastewater facilities). The station is in good condition with the no major operational problems. It is anticipated that equipment will begin to have operational problems as the 20 year useful life span is passed. The station is included in a project to assess equipment replacement and upgrades.

Projects in the Existing FY14 CIP:

- DeLauri Pump Station Improvements (for electrical room cooling and security upgrades) design and construction project is programmed in the FY14 CIP (within the Interceptor and Pumping Facility Asset Protection Project) at a cost of \$407,000 in FY14-15. This project will also include security upgrades for the facility.
- The DeLauri Pump Station is included in the Pump Station and CSO Condition Assessment for 10 Older Facilities project that is programmed in the FY14 CIP at a cost of \$3.0 million in FY15-17. This project will provide professional engineering services (via an RFQ/P process) including design review, inventory, evaluation, identification and prioritization of rehabilitation/replacement projects and operational processes for MWRA's ten older pump stations and CSO facilities. The ten older pump station and CSO facilities to be included in the condition assessment project are: Alewife Brook, Caruso, Chelsea Screen House, DeLauri, Hayes, Hingham, Prison Point, Wiggins - Castle Island Terminal, Cottage Farm, and Somerville Marginal. The consultant will review the

adequacy of existing components and processes and provide recommendations based upon the latest/alternative technology. Information developed by this project will be used by MWRA to produce a list of recommended design/construction upgrade projects by facility, priority, and fiscal year.

- Pump Station and CSOs Rehabilitation Preliminary Design/Study for 6 of 10 Older Facilities is programmed in the FY14 CIP at a cost of \$750,000 in FY16-21. This project will provide preliminary design services (via an RFQ/P process) for six of the ten older pump stations and CSO facilities (Caruso, DeLauri, Hayes, Hingham, Wiggins - Castle Island Terminal, and Somerville Marginal).

Projects Recommended for Consideration in Future CIPs:

- DeLauri Pump Station Upgrades design and construction is recommended for consideration in future CIPs at an estimated cost of \$25.0 million during the FY19-23 timeframe. Upgrades to be designed/constructed under this project will be identified in the Condition Assessment for 10 Older Facilities project.

DeLauri Pump Station/Charlestown Wind Turbine: In 2011, MWRA installed a 1.5 megawatt wind turbine adjacent to the DeLauri Pump Station in Charlestown. The structure is 364 feet high at blade peak and will generate 3 million kilowatt hours of electricity per year. See Chapter 13 for more information on MWRA alternative energy projects.



10.10 Framingham Pump Station

- Address: Arthur Street, Framingham
- Location Map: See Figure 10-1
- Tributary Area Map: See Figure 10-2
- Average Daily Flow: N/A - This station is activated only during peak flow, generally resulting from an extreme storm event.
- Peak Capacity: 28 mgd

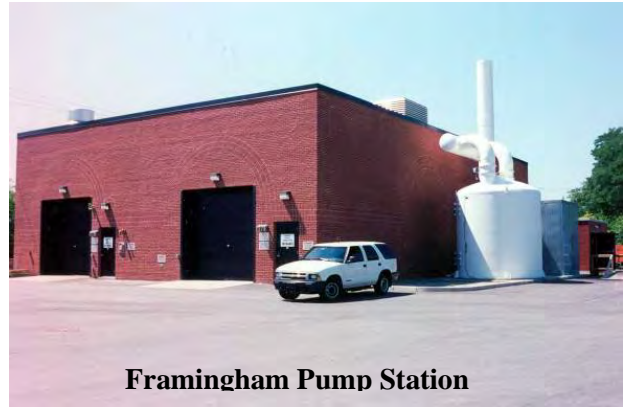

Framingham Pump Station

Facility Function and Operation: Construction of the Framingham Pump Station was completed in 1998 as part of the Framingham Extension Relief Sewer (FERS) project. The pump station and relief sewer were constructed to provide relief for the existing Framingham Extension Sewer (FES). The tributary area includes all of Ashland and Framingham and is served by a separate sanitary sewer system. The facility pumps wastewater from upstream community-owned sewers to the FERS that connects to the downstream Wellesley Extension Sewer (and/or the Wellesley Extension Relief Sewer and Wellesley Extension Sewer Replacement) and the High Level Sewer and ultimately flows to the Nut Island Headworks. During average (dry weather) flow, the facility does not normally activate. During peak (wet weather) flow, the facility can be preset to automatically activate at a trigger flow rate; however, current operational procedures are to activate the facility manually.

Facility Components: Major facility components include: three diversion chamber sluice gates, two mechanical bar screens, three pumps, three electric motors, one influent flow meter (a Palmer-Bowlus Flume meter located at the influent diversion chamber), a wet well bubbletube depth meter, an effluent flow meter, a surge arrestor system, a activated carbon odor control system, and a chemical feed system to control odors and corrosion in the FES.

Hydraulic Performance: The facility is operated only during peak flow conditions. There are no hydraulic performance issues.

Facility Power: The primary electrical feed is from local commercial service. A diesel generator (1250 kW), equipped with automatic start circuitry, provides backup power. Only two pumps can operate under generator power.

Standard Operating Procedures (SOPs): The facility SOP was last updated in 1999.

Force Main: Section 677, 23,660 feet of 36-inch diameter prestressed concrete cylinder pipe with embedded T-Lock lining, constructed in 1999.

Record Drawings: Accession Numbers 200,854 to 200,911.

Condition Assessment and Recent Upgrades: The Framingham Pump Station (1998) is less than 15 years old and is in good condition with the only operational problem associated with high levels of hydrogen sulfide corrosion present in the collection system. Planning for sluice gate upgrade is ongoing. Some automation improvements were constructed under the Transport SCADA Implementation project.



Projects Recommended for Consideration in Future CIPs:

- Framingham Pump Station Force Main Corrosion and Odor Improvements project is recommended for consideration in future CIPs at an estimated cost of \$1.5 million during the FY21-23 timeframe. Modifications at the Framingham Pump Station under this project may include: pump station automation and optimization improvements, FES flow meter modifications, automation of the force main filling, and modifications to the chemical feed facilities.
- Framingham Pump Station Sluice Gate Replacement design and construction for replacement of three 48-inch sluice gates due to excessive hydrogen sulfide corrosion is recommended for consideration in future CIPs at an estimated cost of \$500,000 during the FY21-22 timeframe.
- Framingham Pump Station Screening Automation Study, design, and construction are recommended for consideration in future CIPs at an estimated cost of \$500,000 during the FY21-23 timeframe.
- The Framingham Pump Station is included in the Future Pump Station and CSO Condition Assessment and Upgrades for 10 Newer Facilities project that is recommended for consideration in future CIPs. This project has a placeholder budget estimate of \$100.0 million to assess equipment replacement and upgrades (including planning, design, and construction) during the FY34-53 timeframe. The 10 newer wastewater pump station and CSO facilities include: BOS019 CSO Storage Conduit, Braintree/Weymouth Replacement PS, Framingham PS, Hough's Neck PS, Intermediate PS, New Neponset Valley Sewer PS, North Dorchester Bay CSO Storage and Pump Facility, Quincy PS, Squantum PS, and Union Park CSO Facility.

10.11 Hayes Pump Station

- Address: 100 Redfield Road, Wakefield
- Location Map: See Figure 10-1
- Tributary Area Map: See Figure 10-2
- Average Daily Flow: 3.0 mgd
- Peak Capacity: 9.0 mgd



Facility Function and Operation: The Hayes Pump Station was built in 1987, replacing the former Reading Pump Station originally built in 1921. The Hayes Pump Station lifts wastewater from an upstream portion of the Reading Extension Relief Sewer and upstream community-owned sewers to the downstream portion of the Reading Extension Relief Sewer that connects to the North Metropolitan Relief Sewer and ultimately flows to the Chelsea Creek Headworks. The tributary area includes much of Reading, the northwest corner of Wakefield and several streets in Stoneham. The entire tributary area is served by a separate sanitary sewer system. The former Reading Pump Station building (located adjacent to the Hayes Pump Station on Summer Street in Reading) is used for odor control operations.

Facility Components: Major facility components include: influent sluice gate, one mechanical bar screen, one backup manual bar screen, three 5.5 mgd pumps, three electric motors, two electric screening bypass sluice gates, ultrasonic depth meters to monitor screening channel and wet well levels, and an effluent flow meter.

Hydraulic Performance: Closure (choking) of the influent sluice gate during extreme storm events has been required to protect the station from flooding and may contribute to elevated hydraulic grade lines in the upstream sewers and surcharge/overflow of the Eaton Street interceptor in Reading.

Facility Power: The primary electrical feed is from local commercial service in Wakefield via the Wakefield Municipal Light Department. A diesel generator (365 kW) provides backup power.

Standard Operating Procedures (SOPs): The facility SOP was last updated in 1987.

Force Main: Section 205, 2330 feet of 20-inch diameter ductile iron pipe, constructed in 1984.

Record Drawings: Accession numbers 9,535 to 9,552 and 200,428 to 200,429.

Condition Assessment and Recent Upgrades: The Hayes Pump Station (1987) is 25 years old, somewhat older than the average age for MWRA collection system facilities. The station is in good condition with no major operational problems. It is anticipated that station equipment will begin to have operational problems since the 20 year useful life span is passed. The station is included in a project to assess equipment replacement and upgrades.

Projects in the Existing FY14 CIP:

- The Hayes Pump Station is included in the Pump Station and CSO Condition Assessment for 10 Older Facilities project that is programmed in the FY14 CIP at a cost of \$3.0 million in FY15-17. This project will provide professional engineering services (via an RFQ/P process) including design review, inventory, evaluation, identification and prioritization of rehabilitation/replacement projects and operational processes for MWRA's ten older pump stations and CSO facilities. The ten older pump station and CSO facilities to be included in the condition assessment project are: Alewife Brook, Caruso, Chelsea Screen House, DeLauri, Hayes, Hingham, Prison Point, Wiggins - Castle Island Terminal, Cottage Farm, and Somerville Marginal. The consultant will review the adequacy of existing components and processes and provide recommendations based upon the latest/alternative technology. Information developed by this project will be used by MWRA to produce a list of recommended design/construction upgrade projects by facility, priority, and fiscal year.
- Pump Station and CSOs Rehabilitation Preliminary Design/Study for 6 of 10 Older Facilities is programmed in the FY14 CIP at a cost of \$750,000 in FY16-21. This project will provide preliminary design services (via an RFQ/P process) for six of the ten older pump stations and CSO facilities (Caruso, DeLauri, Hayes, Hingham, Wiggins - Castle Island Terminal, and Somerville Marginal).

Projects Recommended for Consideration in Future CIPs:

- Hayes Pump Station Upgrades Design and Construction is recommended for consideration in future CIPs at an estimated cost of \$12.0 million during the FY21-25 timeframe. Upgrades to be designed/constructed under this project will be identified in the Condition Assessment for 10 Older Facilities project.

10.12 Hingham Pump Station

- Address: 463 Lincoln Street, Hingham
- Location Map: See Figure 10-1
- Tributary Area Map: See Figure 10-2
- Average Daily Flow: 3.5 mgd
- Peak Capacity: 7 mgd



Facility Function and Operation: The Hingham Pump Station was originally built in 1957 and completely rebuilt by MWRA in 1992. This facility lifts wastewater from upstream community-owned sewers in the Hingham North Sewer District to the Braintree/Weymouth Interceptor that connects to the Braintree/Weymouth Replacement Pump Station. The tributary area is comprised of the entire Hingham North Sewer District and is served entirely by separate sanitary sewers. The Hingham North Sewer District includes North Hingham, Hingham High School, Hingham Junior High School, and Wampatuck State Park.

Facility Components: Major facility components include: two comminutors, three 4.85 mgd pumps, three electric motors, ultrasonic depth meters to monitor influent channel elevation and wet well depths, and an effluent flow meter.

Hydraulic Performance: No problems. Previously, only a stop log chamber was available to isolate the station. Construction of an influent isolation gate was completed in 2012 to allow the station to be shut down during maintenance or emergency needs.

Facility Power: The primary electrical power is from local commercial service. A diesel generator (200 kW) provides backup power.

Standard Operating Procedures (SOPs): The facility SOP was last updated in 1992.

Force Main: Section 661 and 662, 7921 feet of 20-inch diameter ductile iron force main, constructed under two separate contracts in 1984 and 1990.

Record Plans: Accession Numbers 9,586 to 9,604b.

Condition Assessment and Recent Upgrades: The Hingham Pump Station (1992) is 20 years old, near average age for MWRA wastewater facilities. The station is in good condition with no major operational problems and no ongoing upgrades other than the isolation gate project. It is anticipated that equipment will begin to have operational problems since the station has passed the 20 year old milestone. The station is included in a project to assess equipment replacement and upgrades. Although the station structure is relatively new, cracks in the facility may indicate a foundation problem. This situation is being monitored by operations staff and should be highlighted in the condition assessment study.

Projects in the Existing FY14 CIP:

- The Hingham Pump Station is included in the Pump Station and CSO Condition Assessment for 10 Older Facilities project that is programmed in the FY14 CIP at a cost of \$3.0 million in FY15-17. This project will provide professional engineering services (via an RFQ/P process) including design review, inventory, evaluation, identification and prioritization of rehabilitation/replacement projects and operational processes for MWRA's ten older pump stations and CSO facilities. The ten older pump station and CSO facilities to be included in the condition assessment project plan are: Alewife Brook, Caruso, Chelsea Screen House, Cottage Farm, DeLauri, Hayes, Hingham, Prison Point, Somerville Marginal, and Wiggins - Castle Island Terminal. The consultant will review the adequacy of existing components and processes and provide recommendations based upon the latest/alternative technology. Information developed by this project will be used by MWRA to produce a list of recommended design/construction upgrade projects by facility, priority, and fiscal year.
- Pump Station and CSOs Rehabilitation Preliminary Design/Study for 6 of 10 Older Facilities is programmed in the FY14 CIP at a cost of \$750,000 in FY16-21. This project will provide preliminary design services (via an RFQ/P process) for six of the ten older pump stations and CSO facilities (Caruso, DeLauri, Hayes, Hingham, Somerville Marginal, and Wiggins - Castle Island Terminal).

Projects Recommended for Consideration in Future CIPs:

- Hingham Pump Station Upgrade design/construction is recommended for consideration in future CIPs at an estimated cost of \$10.0 million during FY21-25. Upgrades will be identified in the Condition Assessment for 10 Older Facilities project.

10.13 Hough's Neck Pump Station

- Address: Nut Island Avenue, Quincy
- Location Map: See Figure 10-1
- Tributary Area Map: See Figure 10-2
- Average Daily Flow: 0.5 mgd
- Peak Capacity: 1.3 mgd

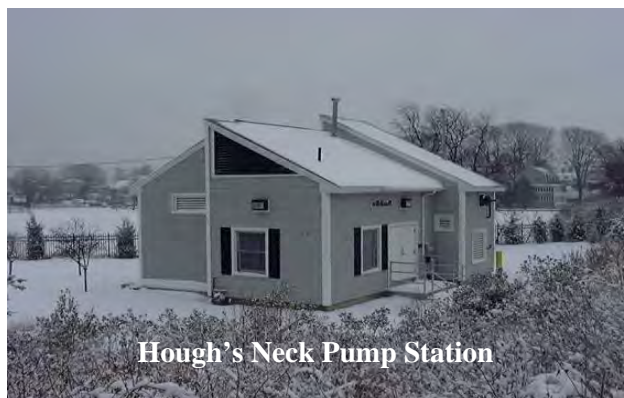

Facility Function and Operation: The Hough's Neck Pump Station was originally built in 1942 and was completely rebuilt by MWRA in 1999. This facility lifts wastewater from upstream community-owned sewers in a small portion of Quincy to the High Level Sewer that connects to the Nut Island Headworks. The 100 acre tributary area is served by separate sanitary sewers.

Facility Components: Major facility components include: one influent sluice gate, one automatic grinder unit, one backup manual bar screen, two submersible pumps, ultrasonic depth meters to monitor the influent channel and wet well depths, an effluent flow meter, and an activated carbon odor control system.

Hydraulic Performance: No problems.

Facility Power: The primary electrical power is from local commercial service. A diesel generator (50 kW) provides backup power.

Standard Operating Procedures (SOPs): The facility SOP was last updated in June 1999.

Force Main: Section 588, 43-feet of 10-inch diameter ductile iron pipe, constructed in 1998.

Record Drawings: Accession Numbers 202474 to 202499.

Condition Assessment and Recent Upgrades: The Hough's Neck Pump Station (1999) is less than 15 years old and is in very good condition. There are no operational problems and no immediate upgrades anticipated.

Projects Recommended for Consideration in Future CIPs:

- The Hough's Neck Pump Station is included in the Future Pump Station and CSO Condition Assessment and Upgrades for 10 Newer Facilities project that is recommended for consideration in future CIPs. This project has a placeholder budget estimate of \$100.0 million to assess equipment replacement and upgrades (including planning, design, and construction) during the FY34-53 timeframe. The 10 newer wastewater pump station and CSO facilities include: BOS019 CSO Storage Conduit, Braintree/Weymouth Replacement PS, Framingham PS, Hough's Neck PS, Intermediate PS, New Neponset Valley Sewer PS, North Dorchester Bay CSO Storage and Pump Facility, Quincy PS, Squantum PS, and Union Park CSO Facility.

10.14 Intermediate Pump Station (IPS)

- Address: 50 Bridge Street, North Weymouth
- Location Map: See Figure 10-1
- Tributary Area Map: See Figure 10-2
- Average Daily Flow: 14.8 mgd
- Peak Capacity: 45 mgd

Facility Function and Operation: The Intermediate Pump Station (IPS) is located in North Weymouth off Route 3A and was built in 2005. Wastewater is pumped from the IPS into a 42-inch force main and conveyed through the Braintree-Weymouth Tunnel and Inter-Island Tunnel to the Deer Island Treatment Plant.

The pump station receives wastewater from Braintree, Holbrook, Randolph, a small portion of Weymouth, and a very small area of Quincy (via the Braintree Howard Street Pump Station). The tributary area is served by separate sanitary sewers. Influent flows to the IPS are from the 60-inch North Weymouth Relief Interceptor downstream of two 36-inch siphons (across the Fore River). Wastewater pumped at the IPS bypasses the Nut Island Headworks; therefore, separate headworks process equipment (screens and grit removal) are an integral part of the IPS. The IPS also receives centrate from MWRA's Residuals Processing Facility at the Fore River Staging Area in Quincy through two 12-inch lines. An additional 12-inch water line supplies potable water from Quincy via the Braintree/Weymouth Tunnel.

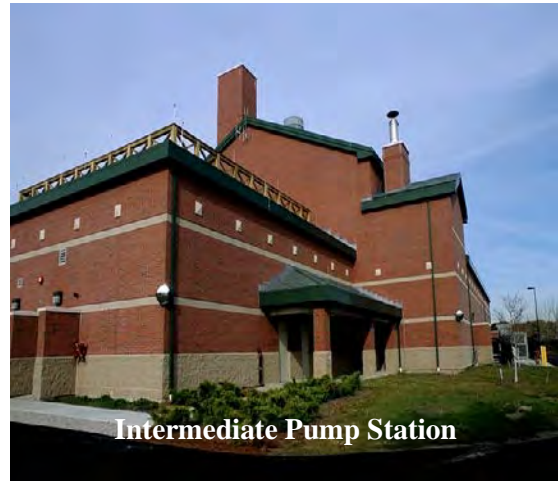

Intermediate Pump Station

Facility Components: Major facility components include: a hydraulic influent sluice gate, grit and screenings removal equipment, four raw wastewater pumps, an effluent flow meter, activated carbon odor control system, an emergency generator, and a lightning protection system. The pump station's first floor level houses an office, lunch room, locker rooms, janitor/laundry room, maintenance storage, radio room, fire pump room, electrical room, generator room, boiler room, mechanical room, container storage room, odor control room, and a truckway. The intermediate level houses a pump motor room and a grit and screenings process area. The lower level houses a pump room, wetwells, channels, and lower sections of the grit and screening process configurations. The attic houses a mechanical room for HVAC equipment. All major areas of the facility contain fire protection sprinklers and internal/external antennas for radio communication.

Hydraulic Performance: No problems.

Facility Power: The primary electrical power is from local commercial service. A diesel generator (2000 kW) provides backup power.

Standard Operating Procedures (SOPs): The facility SOP was prepared in 2005.

Force Main: Section 642A, 152 feet of 42-inch diameter ductile iron force main, constructed in 2000. This force main discharges to the Braintree/Weymouth Tunnel. Integral to the Braintree/Weymouth Tunnel, the 42-inch force main continues for approximately 2 miles and discharges into the Inter-Island Tunnel.

Record Drawings: Accession Numbers 601305 to 601547.

Condition Assessment and Recent Upgrades: The Intermediate Pump Station (2005) is one of MWRA's newer wastewater facilities and is in excellent condition. There are no operational problems and no immediate upgrades are anticipated.

Projects Recommended for Consideration in Future CIPs:

- The Intermediate Pump Station is included in the Future Pump Station and CSO Condition Assessment and Upgrades for 10 Newer Facilities project that is recommended for consideration in future CIPs. This project has a placeholder budget estimate of \$100.0 million to assess equipment replacement and upgrades (including planning, design, and construction) during the FY34-53 timeframe. The 10 newer wastewater pump station and CSO facilities include: BOS019 CSO Storage Conduit, Braintree/Weymouth Replacement PS, Framingham PS, Hough's Neck PS, Intermediate PS, New Neponset Valley Sewer PS, North Dorchester Bay CSO Storage and Pump Facility, Quincy PS, Squantum PS, and Union Park CSO Facility.

10.15 New Neponset Valley Sewer Pump Station

- Address: University Road, Canton
- Location Map: See Figure 10-1
- Tributary Area Map: See Figure 10-2
- Average Daily Flow: N/A – This station is activated only during peak flow, generally resulting from an extreme storm event.
- Peak Capacity: 46 mgd

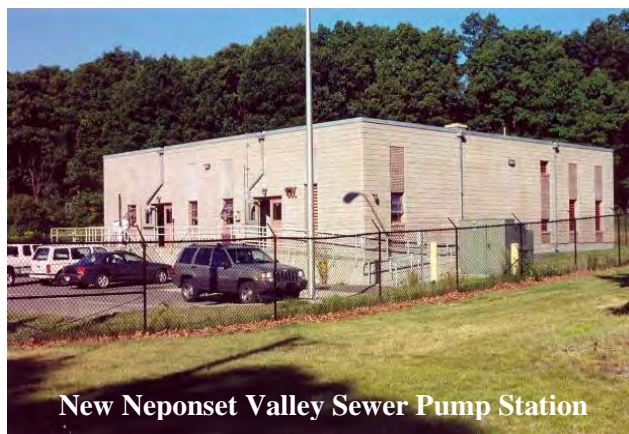

New Neponset Valley Sewer Pump Station

Facility Function & Operation: The New Neponset Valley Sewer Pump Station was built in 1995. The facility was constructed to supplement the hydraulic capacity of the 60-inch New Neponset Valley Sewer. The facility pumps wastewater through a 48-inch force main parallel to the New Neponset Valley Sewer to a downstream location where the capacity of the gravity sewer is greater. The tributary area includes Canton, Norwood, Stoughton, and Walpole and is served by separate sanitary sewers. During average (dry weather) flow, the facility is not operated and is isolated from the New Neponset Valley (gravity) Sewer via gates. During peak (wet weather) flow, the station can be activated either automatically or manually when the wastewater flow elevation in the upstream diversion chamber reaches the activation elevation. When the facility is activated, the New Neponset Valley Sewer can be operated in parallel or can be isolated by diversion gates forcing all flow through the pump station.

Facility Components: Major facility components include: Three variable speed pumps, one automatic inlet sluice gate, one automatic sluice gate for isolation of the New Neponset Valley Sewer, two motorized slide screen gates, one mechanical bar screen, one manual bar screen, three strap-on ultrasonic flow meters, an activated carbon odor control system (installed in 2010), one ultrasonic and one pressure diversion chamber level sensor, and a redundant ultrasonic wet well level sensor.

Hydraulic Performance: When the facility is activated (during wet weather conditions), it serves to relieve potential surcharging and sanitary sewer overflows in the upstream tributary sewers. The pump station force main discharges to the lower reaches of the New Neponset Valley Sewer near the intersection of Brush Hill Road and Neponset Valley Parkway in Milton. Surcharging in the High Level Sewer during extreme storm events may limit the capacity of the downstream portion of the New Neponset Valley Sewer to transport flow.

Facility Power: The primary electrical power is from local commercial service. A diesel generator (900 kW) provides backup power.

Standard Operating Procedures (SOPs): An O&M manual was prepared in 1995.

Force Main: Sections 675, 676, and 676A, 21,409 feet of 48-inch diameter ductile iron pipe, constructed in 1992.

Record Drawings: Accession Numbers 200,587 to 200,635.

Condition Assessment and Recent Upgrades: The New Neponset Valley Sewer Pump Station (1995) is 17 years old and in very good condition. There are no operational problems and no immediate upgrades anticipated.

Projects Recommended for Consideration in Future CIPs:

- The New Neponset Valley Sewer Pump Station is included in the Future Pump Station and CSO Condition Assessment and Upgrades for 10 Newer Facilities project that is recommended for consideration in future CIPs. This project has a placeholder budget estimate of \$100.0 million to assess equipment replacement and upgrades (including planning, design, and construction) during the FY34-53 timeframe. The 10 newer wastewater pump station and CSO facilities include: BOS019 CSO Storage Conduit, Braintree/Weymouth Replacement PS, Framingham PS, Hough's Neck PS, Intermediate PS, New Neponset Valley Sewer PS, North Dorchester Bay CSO Storage and Pump Facility, Quincy PS, Squantum PS, and Union Park CSO Facility.

10.16 North Dorchester Bay CSO Storage and Pump Facilities

- Address: 1950 William J. Day Boulevard, South Boston
- Location Map: See Figure 10-1 and 10-3
- Average Daily Flow: N/A – only operated during peak (wet weather) flow
- Maximum Storage Capacity: 19 million gallons



Facility Function and Operation: The North Dorchester Bay CSO Storage and Pump Facilities were completed and put into operation in 2011. During normal (dry weather) flow conditions, the facility receives minimal infiltration from the tributary stormwater system and tidal waters from leaking tide gates. The dry weather flow tributary area includes portions of South Boston. During storm events, the facility captures stormwater from separate areas that would have discharged to the beaches. BWSC CSO regulators that are overtopped during storm events also add flow to the storage tunnel. Storm water and CSO flows that enter the storage tunnel are screened and pumped back to BWSC's South Boston interceptor, which is tributary to the Columbus Park Headworks.

Facility Components: Major facility components, shown in Figure 10-3, include: 10,830-foot long, 17-foot diameter tunnel that can hold up to a total 19 million gallons of CSO and stormwater flow; CSO and stormwater diversion structures and gates that direct flows into the tunnel at each outfall; a 15 mgd tunnel-dewatering pump station located at Massport's Conley Terminal adjacent to the downstream end of the tunnel, a 24-inch diameter tunnel dewatering force main; a below-ground tunnel ventilation and odor control building behind the State Police Barracks on Day Boulevard (adjacent to the upstream end of the tunnel).

Hydraulic Performance: Activation of the CSO facility during storm events will eliminate CSO activations up to the 25-year storm and eliminate stormwater discharges up to the 5-year storm.

Facility Power: The primary electric power is from local electric service. There is no onsite standby generator.

Standard Operating Procedures (SOPs): The facility SOP was developed in 2011.

Force Main: A 4000 foot long, 24-inch diameter tunnel dewatering force main connects to a local BWSC sewer on N Street.

Outfalls: CSO and stormwater diversion structures were constructed at outfalls BOS081, BOS082, BOS083, BOS084, BOS085, BOS086, and BOS087. Outfalls BOS083 and BOS087 have been closed.

Record Drawings: Accession Numbers 227,848 to 228,007 and 228,977 to 229,048.

FIGURE 10-3
North Dorchester Bay CSO Storage Tunnel and Related Facilities



Condition Assessment and Recent Upgrades: The North Dorchester Bay CSO Storage and Pump Facilities are new and no immediate upgrades are anticipated.

Projects Recommended for Consideration in Future CIPs:

- The North Dorchester Bay CSO Storage and Pump Facilities are included in the Future Pump Station and CSO Condition Assessment and Upgrades for 10 Newer Facilities project that is recommended for consideration in future CIPs. This project has a placeholder budget estimate of \$100.0 million to assess equipment replacement and upgrades (including planning, design, and construction) during the FY34-53 timeframe. The 10 newer wastewater pump station and CSO facilities include: BOS019 CSO Storage Conduit, Braintree/Weymouth Replacement PS, Framingham PS, Hough's Neck PS, Intermediate PS, New Neponset Valley Sewer PS, North Dorchester Bay CSO Storage and Pump Facility, Quincy PS, Squantum PS, and Union Park CSO Facility.

10.17 Prison Point Pump Station and Pumped CSO Facility

- Address: One Monsignor O'Brien Highway, Cambridge
- Location Map: See Figure 10-1
- Tributary Area Map: See Figure 10-2
- Average Daily Flow: 2.5 mgd during normal, dry-weather flow conditions.
- Peak Capacity: 5 mgd peak dry weather pumping, 323 mgd peak wet weather pumping capacity to CSO Outfall MWR203

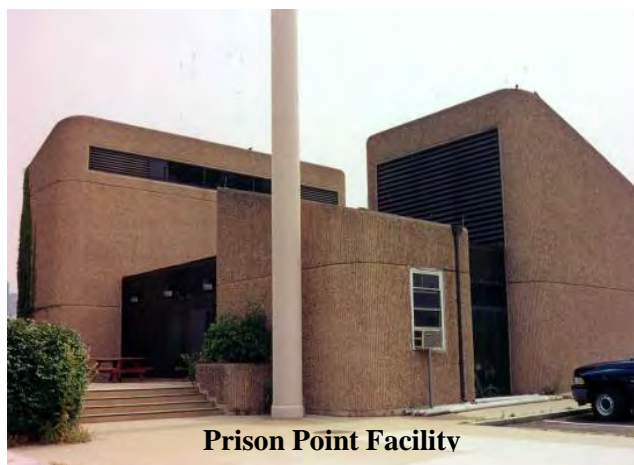

Facility Function and Operation: The Prison Point Pump Station and Pumped CSO Facility was built in 1980 and an upgrade of the facility was completed by MWRA in 1999. Upgrades of the HVAC and odor controls systems were completed in FY12. During normal (dry weather) flow conditions, wastewater collected in the Cambridge Marginal Conduit and Boston Marginal Conduit is pumped from the facility via an 18-inch force main that discharges to the Charlestown Branch Sewer and ultimately flows to the Chelsea Creek Headworks. The dry weather flow tributary area includes portions of Cambridge and Boston and is served by mostly combined sewers. During peak (wet weather) flows, the facility provides screening, sedimentation, and disinfection treatment for wastewater collected in: (1) the Cambridge Marginal Conduit, (2) the Boston Marginal Conduit, (3) combined sewer overflow from 96-inch McGrath Highway Somerville/Cambridge Sewer, and (4) combined sewer overflow from a regulator on the Charlestown Branch Sewer (60-inch Millers River Overflow Interceptor). Wet weather flows are screened and chlorinated before discharge to the sedimentation/detention tanks (1.2 mg volume). The flow is dechlorinated and discharged to the Upper Inner Harbor at CSO Outfall MWR203 via a 96-inch force main. The wet weather system provides treatment for flows up to 323 mgd and a detention time of approximately 5.5 minutes at peak flow. During smaller storms, the entire CSO volume may be stored in the sedimentation/detention tanks and pumped back to the Charlestown Branch Sewer.

Facility Components: Major facility components include: one influent sluice gate, one dry weather flow sluice gate, three wet weather inlet structure sluice gates, one dry weather flow mechanical screen and grinder, three wet weather flow mechanical screens, six 200,000 gallon sedimentation/detention tanks, two 2.5 mgd dry weather flow pumps, four diesel engine driven wet weather pumps (three 115 mgd and one 58 mgd), one 2.16 mgd stripping pump, chemical treatment (chlorination and dechlorination) system, one influent dry weather flow parshall flume meter, and one effluent wet weather flow meter.

Hydraulic Performance: Activation of the CSO facility during storm events controls the hydraulic grade line elevations in upstream conduits. Without the facility, combined wastewater would surcharge the upstream system and discharge through several upstream CSO outfalls, including: MWR018, MWR019, and MWR020 along the Boston Marginal Conduit, and CAM017 along the Cambridge Marginal Conduit.

Facility Power: The primary electrical power is from local commercial service. A diesel generator (285 kW) provides backup power.

Standard Operating Procedures (SOPs): The facility SOP was last updated in 2006.

Record Drawings: Record drawings for Contract 6795 - HVAC Upgrades will be completed in FY13.

Dry Weather Force Main: Section 198, 1,934 feet of mostly 18-inch diameter reinforced concrete pipe, constructed in 1974-1977.

Wet Weather Force Main: Section 199, 2,193 feet of mostly 96-inch diameter reinforced concrete pipe, constructed in 1973-1974.

Outfall MWR203: Section 199, 323 feet of mostly 96-inch, 84-inch, and 72-inch diameter reinforced concrete pipe, constructed in 1973.

Condition Assessment and Recent Upgrades: The Prison Point Pump Station and Pumped CSO Facility (1980) is 32 years old. Equipment replaced as part of the upgrade in 1999, under the CSO Control Plan (see Chapter 11), is 13 years old. The facility upgrade included the replacement of the chlorine disinfection system and addition of a dechlorination system, as well as process control and safety improvements. Instrumentation and control improvements were made in 2007 as part of the SCADA Implementation Program. The upgrade of the HVAC and odor controls systems was substantially completed in FY13. The station is in fair to good condition with some rehabilitation projects planned to target specific problems (generator, gearbox, and wet weather pump rebuilds and improvement to the dry weather and stripping pumps). It is anticipated that other station equipment will begin to have operational problems in the upcoming years. The station is included in a project to assess equipment replacement and upgrades.

Projects in the Existing FY14 CIP:

- The Prison Point and Cottage Farm CSO Rehabilitation Preliminary Design/Study project is programmed in the FY14 CIP at a cost of \$1.0 million in FY15-16. This project will develop a plan to replace/upgrade mechanical, electrical, chemical feed, and instrumentation systems; conversion to electric variable frequency drives; and redundancy concerns at the two stations.
- The Prison Point and Cottage Farm Facilities Upgrade project including generators and Prison Point pump and gear box is programmed in the FY14 CIP at a cost of \$5.099 million in FY14-15.
- The Prison Point HVAC Upgrades design and construction project is programmed in the FY14 CIP at a remaining cost to complete of \$460,000 in FY14.
- The Prison Point piping rehabilitation project is programmed in the FY14 CIP at a cost of \$331,000 in FY14.
- The Prison Point Dry Weather Flow and Stripping Pump Improvements project is programmed in the FY14 CIP at a cost of \$750,000 in FY15-17. This project will determine the feasibility of replacing the two dry weather pumps and adding a second wet well stripping pump to increase operational flexibility and reliability.
- The Prison Point Pump Station and Pumped CSO Facility is included in the Pump Station and CSO Condition Assessment for 10 Older Facilities project that is programmed in the FY14 CIP at a cost of \$3.0 million in FY15-17. This project will provide professional engineering services (via an RFQ/P process) including design review, inventory, evaluation, identification and prioritization of rehabilitation/replacement projects and operational processes for MWRA's ten older pump stations and CSO facilities. The ten older pump station and CSO facilities to be included in the condition assessment project are: Alewife Brook, Caruso, Chelsea Screen House, Cottage Farm, DeLauri, Hayes, Hingham, Prison Point, Somerville Marginal, and Wiggins - Castle Island Terminal. The consultant will review the adequacy of existing components and processes and provide recommendations based upon the latest/alternative technology. Information developed by this project will be used by MWRA to produce a list of recommended design/construction upgrade projects by facility, priority, and fiscal year.

Projects Recommended for Consideration in Future CIPs:

- Prison Point Pump Station and Pumped CSO Upgrades design and construction is recommended for consideration in future CIPs at an estimated cost of \$20.0 million during the FY19-28 timeframe. Upgrades to be designed/constructed under this project will be identified in the Condition Assessment for 10 Older Facilities project.

10.18 Quincy Pump Station

- Address: 41 Fenno Street, Quincy
- Location Map: See Figure 10-1
- Tributary Area Map: See Figure 10-2
- Average Daily Flow: 6 mgd
- Peak Capacity: 22 mgd



Facility Function and Operation: The Quincy Pump Station was built in 2002. This facility replaced the original pump station built in 1908. The Quincy Pump Station lifts wastewater from upstream community-owned sewers in Quincy to the High Level Sewer that connects to the Nut Island Headworks. The 3,100 acre tributary area is served by separate sanitary sewers.

Facility Components: Major facility components include: three variable speed pumps, one motorized inlet sluice gate, one in-channel grinder, one manual bar screen, one magnetic flow meter, and two wet well level sensors.

Hydraulic Performance: No problems.

Facility Power: The primary electrical power is from local commercial service. A diesel generator (500 kW) provides backup power.

Standard Operating Procedures (SOPs): The facility SOP was last updated in 2004.

Force Main: Section 660, 2754 feet of 30-inch diameter cast iron pipe, constructed in 1923 and cement lined in 1999.

Record Drawings: Accession Numbers 600,713 to 600,766.

Condition Assessment and Recent Upgrades: The Quincy Pump Station (2002) is 10 year old and is in very good condition. There are no operational problems and no immediate upgrades are anticipated.

Projects Recommended for Consideration in Future CIPs:

- The Quincy Pump Station is included in the Future Pump Station and CSO Condition Assessment and Upgrades for 10 Newer Facilities project that is recommended for consideration in future CIPs. This project has a placeholder budget estimate of \$100.0 million to assess equipment replacement and upgrades (including planning, design, and construction) during the FY34-53 timeframe. The 10 newer wastewater pump station and CSO facilities include: BOS019 CSO Storage Conduit, Braintree/Weymouth Replacement PS, Framingham PS, Hough's Neck PS, Intermediate PS, New Neponset Valley Sewer PS, North Dorchester Bay CSO Storage and Pump Facility, Quincy PS, Squantum PS, and Union Park CSO Facility.

10.19 Somerville Marginal Gravity CSO Facility

- Address: 274 Mystic Avenue, Somerville
- Location Map: See Figure 10-1
- Average Daily Flow: N/A – only operated during peak (wet weather) flow
- Peak Capacity: 145 mgd (dependent on downstream tide elevation)

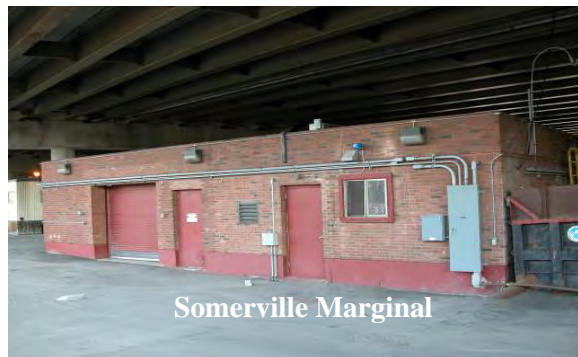

Facility Function & Operation: The Somerville Marginal Gravity CSO Facility was built in 1971 with some upgrades completed in 2001 under the CSO Control Plan. The facility is designed to provide screening and disinfection to combined sewer overflows prior to discharge to the Mystic River via outfalls SOM007A/MWR205A and MWR205. The facility serves to prevent excessive surcharge and possible flooding in the upstream East Somerville community system. The tributary area (approximately 700 acres) includes both combined and separate sanitary sewers. The station is activated by opening the influent gates when the hydraulic gradeline at regulators within McGrath Highway exceeds a high weir elevation and the level in the facility influent structure rises to a predetermined set-point. Flow entering the CSO facility receives screening and disinfection (chlorination) prior to being discharged by gravity to the 7.5x10-foot outfall conduit that receives additional stormwater from downstream systems. The CSO flow is dechlorinated at the downstream remote sampling building. CSO discharges either occur downstream of the Amelia Earhart Dam (through permitted outfall MWR205 during mid to low tides), or upstream of the dam (through permitted outfall SOM007A/MWR205A during mid to high tide). The facility is deactivated when the depth of flow entering the facility falls below a predetermined set-point or the flow through the facility stops due to high downstream tidal elevations.

Facility Components: Major facility components include: two automatic influent sluice gates, two automatic bar screens, two 6,000 gallon hypochlorite storage tanks, two 4,000 gallon sodium bisulfite storage tanks, chemical feed system including a remote sample building, and two flow meters (influent and trans conduit).

Hydraulic Performance: The CSO facility accepts overflow from upstream CSO regulators and storm drains. Upstream CSO regulators provide relief to the local combined collection system that flows to the Somerville-Medford Branch Sewer under dry weather conditions. The facility discharges to the Somerville Marginal Conduit which conveys flow to the Mystic River through one of two outfalls - either downstream of the Amelia Earhart Dam (through permitted outfall MWR205 during mid to low tides) or upstream of the dam (through permitted outfall SOM007A/MWR205A during mid to high tide). Mean high water downstream of the dam is approximately elevation 110 (MWRA base), but can rise to approximately 115 (MWRA base) during extreme tides or storm surges. The normal elevation of the Mystic River Basin is approximately elevation 107 (MWRA base). The two CSO outfall discharges provide operational flexibility and allow the gravity facility to continue to function under high tides.

Facility Power: The primary electrical power is from local commercial service. A diesel generator (100 kW) provides backup power.

Standard Operating Procedures (SOPs): The facility SOP was last updated in 2009.

Force Main: N/A – Somerville Marginal Gravity CSO is a gravity facility.

Record Drawings: Accession Numbers 10280 to 10295.

Condition Assessment and Recent Upgrades: The Somerville Marginal Gravity CSO Facility (1971) is 41 years old, twice the average age for MWRA facilities and is well beyond the 20-year old milestone. In 2001, MWRA completed an upgrade project under the CSO Control Plan (see Chapter 11). The facility upgrades included replacement of the chlorine disinfection system and addition of a dechlorination system, as well as process control and safety improvements. Additional instrumentation and automation upgrades were performed at the facility in 2007. In addition, the electrically actuated facility influent gates were replaced in 2011 along with the installation of stop logs upstream and downstream of the facility and small dewatering pumps to ensure CSO flow does not enter the receiving water prior to facility activation. The main station building remains in fair to good condition. There are no major operational problems. The separate chemical storage and remote sampling buildings are in very good condition. It is anticipated that station equipment will begin to have operational problems due to the age of the facility. The station is included in a project to assess equipment replacement and upgrades.

Projects in the Existing FY14 CIP:

- The Somerville Marginal Gravity CSO Facility is included in the Pump Station and CSO Condition Assessment for 10 Older Facilities project that is programmed in the FY14 CIP at a cost of \$3.0 million in FY15-17. This project will provide professional engineering services (via an RFQ/P process) including design review, inventory, evaluation, identification and prioritization of rehabilitation/replacement projects and operational processes for MWRA's ten older pump stations and CSO facilities. The ten older pump station and CSO facilities to be included in the condition assessment project are: Alewife Brook, Caruso, Chelsea Screen House, Cottage Farm, DeLauri, Hayes, Hingham, Prison Point, Somerville Marginal, and Wiggins - Castle Island Terminal. The consultant will review the adequacy of existing components and processes and provide recommendations based upon the latest/alternative technology. Information developed by this project will be used by MWRA to produce a list of recommended design/construction upgrade projects by facility, priority, and fiscal year.
- Pump Station and CSOs Rehabilitation Preliminary Design/Study for 6 of 10 Older Facilities is programmed in the FY14 CIP at a cost of \$750,000 in FY16-21. This project will provide preliminary design services (via an RFQ/P process) for six of the ten older pump stations and CSO facilities (Caruso, DeLauri, Hayes, Hingham, Somerville Marginal, and Wiggins - Castle Island Terminal).

Projects Recommended for Consideration in Future CIPs:

- Somerville Marginal Gravity CSO Facility Upgrades Design and Construction is recommended for consideration in future CIPs at an estimated cost of \$5.0 million during the FY21-25 timeframe. Upgrades to be designed/constructed under this project will be identified in the Condition Assessment for 10 Older Facilities project.

10.20 Squantum Pump Station

- Address: 36 Newland Street, Quincy
- Location Map: See Figure 10-1
- Tributary Area Map: See Figure 10-2
- Average Daily Flow: 1.2 mgd
- Peak Capacity: 7.5 mgd

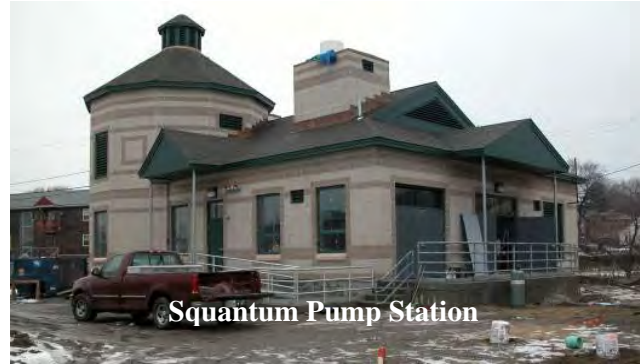

Facility Function & Operation: The Squantum Pump Station was built in 2003. This facility replaced the original pump station built in 1930. The Squantum Pump Station lifts wastewater from upstream community-owned sewers in Quincy to the High Level Sewer that connects to the Nut Island Headworks. The small tributary area (approximately 500 acres) is served by separate sanitary sewers.

Facility Components: Major facility components include: four variable speed pumps, one motorized inlet sluice gate, one in-channel grinder, two manual bar screens, one magnetic flow meter, and two wet well level sensors.

Hydraulic Performance: No problems.

Facility Power: The primary electrical power is from local commercial service. A diesel generator (250 kW) provides backup power.

Standard Operating Procedures (SOPs): The facility SOP was last updated in 2004.

Force Main: Sections 659, 659A, and 659B; 4,582 feet of 24-inch diameter ductile iron pipe, constructed in 1969 and rehabilitated with cured-in-place liner in 1995; 8,115 feet of 30-inch diameter ductile iron pipe, constructed in 1969/70 and cement lined in 1999 with approximately 1,000 feet of cured-in-place liner used for the most corroded sections; 6,307 feet of 30-inch diameter prestressed concrete cylinder pipe, constructed in 1970. Cathodic protection was installed on the 8,115 foot portion of ductile iron pipe in 2002/2003. In April 2010, 375 linear feet of the 30-inch diameter prestressed concrete cylinder pipe portion of force main was repaired with a cured-in-place liner after the failure of a 50-foot section caused by internal hydrogen sulfide corrosion at a high point in the force main. Since the 40-year old force main is nearing the end of its useful life and is subject to internal corrosion from hydrogen sulfide, it should be replaced. In Chapter 9 of the Wastewater System Master Plan (Section 9.08 – Force Mains and Related Valves), a force main asset protection project is recommended for consideration in future CIPs at a total cost of \$20.0 million during FY14-33. A portion of these funds may be used for future planning, design, and construction for replacement of the Squantum Pump Station force main.

Record Drawings: Accession Numbers 203,154 to 203,205.

Condition Assessment and Recent Upgrades: The Squantum Pump Station (2003) is nine years old and is in excellent condition. There are no operational problems and no immediate upgrades are anticipated.

Projects Recommended for Consideration in Future CIPs:

- The Squantum Pump Station is included in the Future Pump Station and CSO Condition Assessment and Upgrades for 10 Newer Facilities project that is recommended for consideration in future CIPs. This project has a placeholder budget estimate of \$100.0 million to assess equipment replacement and upgrades (including planning, design, and construction) during the FY34-53 timeframe. The 10 newer wastewater pump station and CSO facilities include: BOS019 CSO Storage Conduit, Braintree/Weymouth Replacement PS, Framingham PS, Hough's Neck PS, Intermediate PS, New Neponset Valley Sewer PS, North Dorchester Bay CSO Storage and Pump Facility, Quincy PS, Squantum PS, and Union Park CSO Facility.

10.21 Union Park CSO Facility

- Address: 120 Malden Street, Boston
- Location Map: See Figure 10-1
- Average Daily Flow: N/A – only operated during peak (wet weather) flow
- Peak Capacity: Approximately 330 mgd (BWSC's pumping capacity)



Facility Function and Operation: The Union Park CSO Facility was constructed in 2007. The facility provides detention and treatment to CSO flows that are discharged through BWSC's Union Park Pump Station and ultimately discharge into the Fort Point Channel via outfall BOS070. BWSC's Union Park Street Pump Station, constructed in 1976, provides flood control for the South End neighborhood of Boston. Wastewater flow passes through the CSO treatment facility before entering BWSC's pumping station wet well. The CSO facility is designed to run automatically and includes coarse screens, fine screens, chlorination with sodium hypochlorite, dechlorination with sodium bisulfite and odor control equipment. Flow retained in the CSO detention basin is pumped to a BWSC sewer in Malden Street when capacity becomes available after a storm event.

The Union Park CSO Facility is operated via an outside contract that is jointly managed and paid for by BWSC and MWRA. The cost of the contract is mostly covered by BWSC (73 percent) given the inclusion of nine other small BWSC-owned pump stations in the contract. The current 3-year contract began in February 2012. At the end of the contract (February 2015), MWRA and BWSC have the option to extend the contract for up to two additional years. MWRA staff review and approve contractor invoices, review reports used for regulatory reporting purposes, and monitor the contractor's performance.

CSO Facility Components: Major facility components for the Union Park CSO Facility include: six detention basins, two coarse screens, four fine screens, six 250 gpm dewatering pumps, odor control equipment, and flushing gates.

Union Park Pump Station Pumps: BWSC's Union Park Pump Station includes six wet weather pumps – four 100 mgd diesels and two 17 mgd electric.

Hydraulic Performance: The CSO building was constructed adjacent to the BWSC Union Park Pump Station to house the CSO treatment equipment. New underground detention basins have a combined storage capacity of 2.2 million gallons. The CSO facility storage capacity reduces the number of pumping station discharges to the Fort Point Channel.

Facility Power: The primary electrical power is from local commercial service. A diesel generator (1250 kW) provides backup power.

Standard Operating Procedures (SOPs): An O&M manual was developed in 2008 and updated in 2011.

Force Main: The CSO Facility dewatering force main is a 22-foot long, 10-inch diameter ductile iron pipe that connects to an existing BWSC sewer on Malden Street. The discharge line is owned and maintained by BWSC.

Record Drawings: Accession numbers 225365 to 225586.

Condition Assessment and Recent Upgrades: The Union Park CSO Facility was constructed in 2007. This is a new facility and no immediate upgrades are anticipated.

Projects Recommended for Consideration in Future CIPs:

- The Union Park CSO Facility is included in the Future Pump Station and CSO Condition Assessment and Upgrades for 10 Newer Facilities project that is recommended for consideration in future CIPs. This project has a placeholder budget estimate of \$100.0 million to assess equipment replacement and upgrades (including planning, design, and construction) during the FY34-53 timeframe. The 10 newer wastewater pump station and CSO facilities include: BOS019 CSO Storage Conduit, Braintree/Weymouth Replacement PS, Framingham PS, Hough's Neck PS, Intermediate PS, New Neponset Valley Sewer PS, North Dorchester Bay CSO Storage and Pump Facility, Quincy PS, Squantum PS, and Union Park CSO Facility.

10.22 Wiggins - Castle Island Terminal Pump Station

- Address: Conley Terminal, South Boston
- Location Map: See Figure 10-1
- Average Daily Flow: 0.1 mgd
- Peak Capacity: 0.5 mgd



Facility Function and Operation: The Wiggins - Castle Island Terminal Pump Station was originally built in 1943 by the US Navy and likely upgraded in 1960 when upstream sewers were extended. This facility lifts wastewater from the upstream MWRA Castle Island and Conley Terminal Sewer and discharges flow to a local BWSC sewer on Day Boulevard. Wastewater from this station is tributary to the Columbus Park Headworks. The tributary area is a small portion of South Boston that includes Department of Conservation and Recreation facilities on Castle Island and MassPort facilities at Conley Terminal.

Facility Components: Facility components include two 350 gpm pumps and a manual screen.

Hydraulic Performance: No problems.

Facility Power: The primary electrical power is from local commercial service. No backup power is provided. A future project to add a generator is recommended.

Standard Operating Procedures (SOPs): There is no written SOP for this facility.

Force Main: The 8-inch diameter force main is short and connects to a local BWSC sewer.

Record Drawings: Accession numbers 201,668 and 42,260 through 42,263.

Condition Assessment and Recent Upgrades: The Wiggins - Castle Island Terminal Pump Station is the second oldest (1960) and the smallest of the 20 MWRA facilities reviewed in this Chapter. The station is in fair to poor condition. The pumps have been replaced by in house staff as needed and are currently in good condition. The facility is inspected monthly by Operations staff to ensure the facility is in good working order. If Operations identifies that the screen requires cleaning, in house staff complete the screen cleaning. The entire facility should be evaluated for upgrade or replacement.

Projects in the Existing FY14 CIP:

- The Wiggins – Castle Island Terminal Pump Station is included in the Pump Station and CSO Condition Assessment for 10 Older Facilities project that is programmed in the FY14 CIP at a cost of \$3.0 million in FY15-17. This project will provide professional engineering services (via an RFQ/P process) including design review, inventory, evaluation, identification and prioritization of rehabilitation/replacement projects and operational processes for MWRA’s ten older pump stations and CSO facilities. The ten older pump station and CSO facilities to be included in the condition assessment project are: Alewife Brook, Caruso, Chelsea Screen House, Cottage Farm, DeLauri, Hayes, Hingham, Prison Point, Somerville Marginal, and Wiggins - Castle Island Terminal. The consultant will review the adequacy of existing components and processes and provide recommendations based upon the latest/alternative technology. Information developed by this project will be used by MWRA to produce a list of recommended design/construction upgrade projects by facility, priority, and fiscal year.
- Pump Station and CSOs Rehabilitation Preliminary design/study for 6 of 10 Older Facilities is programmed in the FY14 CIP at a cost of \$750,000 in FY16-21. This project will provide preliminary design services (via an RFQ/P process) for six of the ten older

pump stations and CSO facilities (Caruso, DeLauri, Hayes, Hingham, Somerville Marginal, and Wiggins - Castle Island Terminal).

Projects Recommended for Consideration in Future CIPs:

- Wiggins – Castle Island Terminal Pump Station Upgrades and Generator Addition design and construction is recommended for consideration in future CIPs at an estimated cost of \$3.0 million during the FY17-18 timeframe. Upgrades to be designed/constructed under this project will be identified in the Condition Assessment for 10 Older Facilities project.

10.23 Braintree Howard Street Pump Station

MWRA, through agreement with the Town of Braintree, utilizes Braintree’s Howard Street Pump Station to transport wastewater from a small portion of Quincy. MWRA pays Braintree an annual fee for the use of the Town’s wastewater facilities. Costs for use of Braintree’s Howard Street Pump Station are an annual Field Operations CEB expense.

In 1962, the Massachusetts Legislature enacted “Chapter 684 – An act authorizing the MDC to construct certain sewerage works in the Town of Braintree and to contract with the Town of Braintree for the disposal of sewage from a low area in the City of Quincy.” On September 12, 1962, MDC and the Town of Braintree entered into an Agreement that allowed MDC to connect to and use a portion of the available capacity in Braintree’s Howard Street Pump Station to transport sewage from a small section of Quincy. Subsequently, the MDC constructed Sewer Section 654 (previously known as Section 125A under MDC nomenclature), a 210 foot, 8-inch diameter vitrified clay pipe constructed in West Howard Street in Braintree. The MDC sewer was put into service on July 1, 1963. The Agreement provided that MDC would pay Braintree annually for use of the Town’s sewage facilities.

On March 19, 1990, MWRA and the Town of Braintree signed a successor Agreement regarding MWRA’s use of the Town’s Howard Street Pump Station. The Agreement provided that MWRA would make payments to the Town for fiscal years 1990 through 1995 equivalent to 25 percent of the total annual cost of operating, maintaining, and constructing capital improvements to the pump station. All MWRA wholesale sewer charges were separate and distinct from payments under the Agreement. On January 15, 2003, the MWRA Board of Directors authorized payment to Braintree for MWRA’s past use of the Howard Street Pump Station for fiscal years through 2002, pursuant to conditions of the 1990 Agreement. MWRA and Braintree began negotiations regarding a successor Agreement to the 1990 Agreement; however, as of June 2013, no successor Agreement had been executed. As of June 2013, the last bill from Braintree to MWRA for use of the Town’s Howard Street Pump Station (and subsequent payment from MWRA to Braintree) was for FY02.

MWRA In-House Task:

- The MWRA should continue to work with the Town of Braintree to finalize a successor Agreement to the 1990 Agreement regarding MWRA’s use of Braintree’s Howard Street Pump Station. A new Agreement should be approved by the MWRA Board of Directors. An annual bill should be assessed from Braintree to MWRA and an annual payment should be made by MWRA to Braintree.

10.24 Decommissioned Facilities and Historical Structures

Some MWRA pump stations facilities have been decommissioned and no longer serve their original purpose; however, future capital or maintenance expenditures may be needed at some of these facilities. In addition, the potential for historical significance of older structures may impact MWRA's decision making. A summary is provided in this section.

Charlestown Pump Station: The former Charlestown Pump Station, located at 171 Alford Street in Charlestown, was originally constructed in 1895. The function of this station was replaced by the DeLauri Pump Station in 1993. However, the influent siphon to the DeLauri Pump Station (after crossing under the Mystic River), is located beneath the building footprint of the former Charlestown Pump Station. The Charlestown Pump Station building is national register eligible. A Memorandum of Agreement between MWRA, EPA, MHC, and the Advisory Council was signed in 1995. MWRA continues to evaluate reuse options for the facility. Pipeline easements must be maintained to facilitate future rehabilitation options for the influent sewer to the DeLauri Pump Station.

Commercial Point Gravity CSO Facility: The former Commercial Point Gravity CSO Facility, located at 50 Park Street, Dorchester, was built in 1991. The facility provided screening and disinfection to combined sewer overflows prior to discharge to the Commercial Point CSO Outfall (BOS090). The facility was decommissioned by MWRA in 2008 following completion of sewer separation construction in the tributary area. The building is still being maintained by MWRA to a level which permits the fire protection system to function. Given that this includes a sprinkler system, the facility is still heated to a temperature to prevent pipes from freezing. A demolition cost estimate of approximately \$330,000 was prepared in spring of 2009 with the assistance of a task order consultant.

Constitution Beach Gravity CSO Facility: The former Constitution Beach Gravity CSO Facility is located in East Boston. The facility provided screening and disinfection to combined sewer overflows prior to discharge to the Constitution Beach CSO Outfall (BOS002/MWR207). It was decommissioned by MWRA in 2000 following completion of sewer separation construction in the tributary area. The building and site were transferred to the control of the Division of Capital Asset Management (DCAM). MWRA has no further responsibility for this building.

East Boston Electric Pump Station: The former East Boston Electric Pump Station building, located at 600 Chelsea Street in East Boston, was constructed in 1938. The function of this station was replaced by the Caruso Pump Station. The property was surplus to DCAM in June 2002. MWRA has no further responsibility for this building.

East Boston Steam Pump Station: The former East Boston Steam Pump Station building, located at 20 Addison Street in East Boston, was constructed in 1894. The function of this station was replaced by the Caruso Pump Station. The building is national register eligible. The property was surplus to DCAM in 2004 and MWRA has no further responsibility for this building. Easement rights were retained for MWRA Sewer Section 37.5 in East Boston.

Fox Point Gravity CSO Facility: The former Fox Point Gravity CSO Facility, located at 170 Freeport Street in Dorchester, was built in 1989. The facility provided screening and disinfection to combined sewage and stormwater runoff prior to discharge to the Fox Point CSO Outfall

(BOS089) or the Malibu Beach CSO Outfall (BOS088). The facility was decommissioned by MWRA in 2008 following completion of sewer separation construction in the tributary area. The building is still being maintained by MWRA to a level which permits the fire protection system to function. Given that this includes a sprinkler system, the facility is still heated to a temperature to prevent pipes from freezing. A demolition cost estimate of approximately \$330,000 was prepared in spring of 2009 with the assistance of a task order consultant.

Mystic Pump Station/Mystic Shops: The former Mystic Pump Station building, located at two Capen Court in Somerville, was constructed in 1864. The function of this station was replaced by the Alewife Pump Station. The building is on the National Register. MWRA's future need and use of this property is uncertain and should be determined.

Ward Street Pump Station: The former Ward Street Pump Station, located off Ward Street in Roxbury, was constructed in 1938. The function of this station was replaced by the Ward Street Headworks in 1967. The Ward Street Pump Station building was demolished in 1968. This property was previously surplus to DCAM but easement rights were retained for two 48-inch force mains. Staff should investigate if any additional work may be required to finalize abandonment of the pipelines associated with the former pump station.

MWRA In-House Task:

- Staff should implement an in-house task to evaluate/assess all decommissioned facilities not yet surplus and all facilities that may have historical significance. A prioritized list of action items and schedule required for facility reuse study, coordination with Massachusetts Historical Commission, coordination for surplus to DCAM, etc. should be developed. This project may require use of as-needed consultants.

10.25 Reinvestment Needs Based on Estimated Replacement Asset Value

MWRA staff developed a replacement cost valuation of MWRA's infrastructure using MWRA-specific appraisal data and actual MWRA project cost information during development of the 2006 Master Plan. For the 2013 update of the Master Plan, the 2006 replacement asset value analysis was reused (in 2006 dollars) with only minor revisions for new facilities added between 2007 and 2013. One of the revisions was an increase of \$260 million (change from \$370 million to \$630 million) in the Pump Stations and CSO Facilities category that was made to account for the following new facilities: Union Park CSO Facility, BOS019 CSO Storage Conduit, Braintree/Weymouth Replacement Pump Station, and North Dorchester Bay CSO Storage and Pump Facilities. Based on this analysis, MWRA's twenty pump stations and CSO facilities have a replacement asset value of \$630 million. Staff then applied industry benchmarks for asset useful life (50 years for structural components and 20 years for equipment components) to estimate reinvestment needs. For pump station and CSO facilities, 60 percent of the asset value was allocated as structural (50 year useful life) components and 40 percent of the asset value was allocated as equipment (20 year useful life) components. Using the allocated asset value and dividing by the expected useful life, produces an overall estimated reinvestment need of \$20 million per year for pump stations and CSO facilities. It is assumed that the majority of this reinvestment need will be met via specific large-scale rehabilitation/replacement projects that will be fully detailed, evaluated, and justified within MWRA's annual CIP process. However, a portion of the reinvestment need is likely to be met via small-scale rehabilitation/replacement

projects that, individually, may be difficult to justify within the annual CIP process. To provide for small-scale rehabilitation/replacement projects at MWRA's pump station and CSO facilities, a Long-term Wastewater Facility Asset Protection Project (for Pump Station and CSO Facilities) is recommended for consideration in future CIPs at an estimated annual cost of \$2.0 million per year (10 percent of the \$20 million total estimated annual reinvestment need) during the FY24-53 timeframe. Planning should consider potential increases in flood elevations and tidal surge due to impacts from climate change. Planning should also include hazardous material removal/disposal and rehabilitation projects which may be identified. Similar long-term asset protection funds are recommended separately for remote headworks (see Chapter 8).

10.26 Summary of Existing and Recommended Capital Projects

All Master Plan projects related to collection system pump stations and CSO facilities are summarized in this Section. Table 10-2 lists each project, its priority ranking, and proposed expenditure schedule. A description and needs justification for each project is listed in bullet format. This Section is provided as a summary of all existing and recommended capital projects; each project has been detailed previously in the Chapter within Sections relating to specific facilities or asset types.

Projects in the Existing FY14 CIP:

There are twelve pump station and CSO facility related projects programmed in the FY14 CIP. The projects are described below and summarized in Table 10-2 (see line numbers 10.01 through 10.12).

- Alewife Brook Pump Station Rehabilitation design and construction project is programmed in the FY14 CIP at a total remaining cost of \$9.926 million during FY14-18. The preliminary design report was completed in FY11. The final design (including construction administration and resident inspection services) began in FY12 and construction is scheduled to be complete in FY18. Upgrades will include replacing the three larger station pumps, motors, and piping (adding pump redundancy and increasing pump reliability/efficiency); replacing climber screens and grinders; updating the HVAC system; updating the electrical system; and modifying the building interior. The fourth pump (smallest of the four pumps) was previously replaced under the SCADA Project.
- The Pump Station and CSO Condition Assessment for 10 Older Facilities project is programmed in the FY14 CIP at a cost of \$3.0 million in FY15-17. This project will provide professional engineering services (via an RFQ/P process) including design review, inventory, evaluation, identification and prioritization of rehabilitation/replacement projects and operational processes for MWRA's ten older pump stations and CSO facilities. The ten older pump station and CSO facilities to be included in the condition assessment project are: Alewife Brook, Caruso, Chelsea Screen House, DeLauri, Hayes, Hingham, Prison Point, Wiggins - Castle Island Terminal, Cottage Farm, and Somerville Marginal. The consultant will review the adequacy of existing components and processes and provide recommendations based upon the latest/alternative technology. Information developed by this project will be used by MWRA to produce a list of recommended design/construction upgrade projects by facility, priority, and fiscal year.

- Pump Station and CSOs Rehabilitation Preliminary Design/Study for 6 of 10 Older Facilities is programmed in the FY14 CIP at a cost of \$750,000 in FY16-21. This project will provide preliminary design services (via an RFQ/P process) for six of the ten older pump stations and CSO facilities (Caruso, DeLauri, Hayes, Hingham, Wiggins - Castle Island Terminal, and Somerville Marginal).
- Caruso Pump Station Improvements for generator replacement, HVAC, and fire detection system upgrades design and construction project is programmed in the FY14 CIP (within the Interceptor and Pumping Facility Asset Protection Project) at a cost of \$2.916 million in FY14-16.
- Chelsea Screen House Upgrades design and construction including screens and gates is programmed in the FY14 CIP at an estimated cost of \$3.3 million during FY15-16.
- The Prison Point and Cottage Farm CSO Rehabilitation Preliminary Design/Study project is programmed in the FY14 CIP at a cost of \$1.0 million in FY15-16. This project will develop a plan to replace/upgrade mechanical, electrical, chemical feed, and instrumentation systems; conversion to electric variable frequency drives; and redundancy concerns at the two stations.
- The Prison Point and Cottage Farm Facilities Upgrade including generators and Prison Point pump and gearbox rebuild/rehabilitation project is programmed in the FY14 CIP at a cost of \$5.099 million in FY14-15. This project will replace the station generators and rebuild the Prison Point pumps and the gearbox drives (between motor and pump) to increase operational reliability as recommended in a May 2010 inspection report.
- The Cottage Farm Fuel System Upgrade project is programmed in the FY14 CIP at a remaining cost of \$26,000 in FY14.
- DeLauri Pump Station Improvements (for electrical room cooling and security upgrades) design and construction project is programmed in the FY14 CIP at a cost of \$407,000 in FY14-15. The FY13 CIP was revised to expand this project to include security upgrades.
- The Prison Point HVAC Upgrades design and construction project is programmed in the FY14 CIP at a remaining cost of \$460,000 in FY14.
- The Prison Point Piping rehabilitation project is programmed in the FY14 CIP at a remaining cost of \$331,000 in FY14.
- The Prison Point Dry Weather Flow and Stripping Pump Improvements project is programmed in the FY14 CIP at a cost of \$750,000 in FY15-17. This project will determine the feasibility of replacing the two dry weather pumps and adding a second wet well stripping pump to increase operational flexibility and reliability.

Projects Recommended for Consideration in future CIPs: There are fifteen pump station and CSO facility related projects recommended for consideration in future CIPs. These projects are described below and summarized in Table 10-2 (see line numbers 10.13 to 10.27).

- Operation of all collection system Facilities is monitored via the MWRA SCADA system at the Chelsea OCC. If emergency response is needed, maintenance crews are dispatched. Prolonged operational problems at pump stations and CSO facilities could potentially result in upstream sewer surcharging. A project to review the emergency response plan and the hydraulics associated with sewer surcharging that may be caused by prolonged facility downtime is recommended for consideration in a future CIP at an estimated cost of \$500,000 during FY21-23. Staff recommend an engineering consultant be procured to review wastewater facilities and perform hydraulic modeling to determine the impact of prolonged operations problems (facility downtime, reduced pumping, loss of screens, etc). The analysis would identify critical upstream SSO or back-up locations and elevations and the duration of reduced facility capacity that may result in an SSO at various (higher and lower) wastewater flow rates. Projects that may provide emergency system relief to minimize a diminished level of sewer service would be recommended.
- Alewife Brook Pump Station Upgrades design and construction is recommended for consideration in future CIPs at an estimated cost of \$5.0 million during FY31-35. Upgrades to be designed and constructed under this project will be identified in the Condition Assessment Project for 10 Older Facilities.
- Caruso Pump Station Upgrades design and construction is recommended for consideration in future CIPs at an estimated cost of \$25.0 million during the FY19-23 timeframe. Upgrades to be designed/constructed under this project will be identified in the Condition Assessment for 10 Older Facilities project.
- Cottage Farm Pumped CSO Facility Upgrades design and construction is recommended for consideration in future CIPs at an estimated cost of \$20.0 million during the FY19-28 timeframe. Upgrades to be designed/constructed under this project will be identified in the Condition Assessment for 10 Older Facilities project.
- DeLauri Pump Station Upgrades design and construction is recommended for consideration in future CIPs at an estimated cost of \$25.0 million during the FY19-23 timeframe. Upgrades to be designed/constructed under this project will be identified in the Condition Assessment for 10 Older Facilities project.
- Framingham Pump Station Force Main Corrosion and Odor Improvements project is recommended for consideration in future CIPs at an estimated cost of \$1.5 million during the FY21-23 timeframe. Modifications at the Framingham Pump Station under this project may include: pump station automation and optimization improvements, FES flow meter modifications, automation of the force main filling, and modifications to the chemical feed facilities.

- Framingham Pump Station Sluice Gate Replacement design and construction for replacement of three 48-inch sluice gates due to excessive hydrogen sulfide corrosion is recommended for consideration in future CIPs at an estimated cost of \$500,000 during the FY21-22 timeframe.
- Framingham Pump Station Screening Automation study, design, and construction are recommended for consideration in future CIPs at an estimated cost of \$500,000 during the FY21-23 timeframe.
- Hayes Pump Station Upgrades design and construction is recommended for consideration in future CIPs at an estimated cost of \$12.0 million during the FY21-25 timeframe. Upgrades to be designed/constructed under this project will be identified in the Condition Assessment for 10 Older Facilities project.
- Hingham Pump Station Upgrades design and construction is recommended for consideration in future CIPs at an estimated cost of \$10.0 million during the FY21-25 timeframe. Upgrades to be designed/constructed under this project will be identified in the Condition Assessment for 10 Older Facilities project.
- Prison Point Pump Station and Pumped CSO Upgrades design and construction is recommended for consideration in future CIPs at an estimated cost of \$20.0 million during the FY19-28 timeframe. Upgrades to be designed/constructed under this project will be identified in the Condition Assessment for 10 Older Facilities project.
- Somerville Marginal Gravity CSO Facility Upgrades design and construction is recommended for consideration in future CIPs at an estimated cost of \$5.0 million during the FY21-25 timeframe. Upgrades to be designed/constructed under this project will be identified in the Condition Assessment for 10 Older Facilities project.
- Wiggins – Castle Island Terminal Pump Station Upgrades and Generator Addition design and construction is recommended for consideration in future CIPs at an estimated cost of \$3.0 million during the FY17-18 timeframe. Upgrades to be designed/constructed under this project will be identified in the Condition Assessment for 10 Older Facilities project.
- A long-term Wastewater Facilities Asset Protection Project is recommended for consideration in future CIPs at an estimated annual cost of \$2.0 million per year (10 percent of the \$20 million total estimated annual reinvestment need) during the FY24-53 timeframe. The total estimated project cost over 30 years is \$60.0 million. This project will provide annual baseline target expenditures for asset protection projects for wastewater pump stations and CSO facilities. As specific projects are identified, they will become sub-phases within the target expenditure. Planning should consider potential increases in flood elevations and tidal surge due to impacts from climate change. Planning should also include hazardous material removal/disposal and rehabilitation projects which may be identified.

- The Future Pump Station and CSO Facility Condition Assessment and Upgrades for 10 Newer Facilities project is recommended for consideration in future CIPs. This project has a placeholder budget estimate of \$100.0 million to assess equipment replacement and upgrades (including planning, design, and construction) during the FY34-53 timeframe. The 10 newer wastewater pump station and CSO facilities include: BOS019 CSO Storage Conduit, Braintree/Weymouth Replacement PS, Framingham PS, Hough's Neck PS, Intermediate PS, New Neponset Valley Sewer PS, North Dorchester Bay CSO Storage and Pump Facility, Quincy PS, Squantum PS, and Union Park CSO Facility.

**Table 10-2
Wastewater Master Plan - Pump Stations and CSO Facilities
Existing and Recommended Projects**

Last revision 8/6/13

Priority
1 Critical
2 Essential
3 Necessary
4 Important
5 Desirable

Project Types
NF New Facility/System
RF/IC Replacement Facility/Increase Capacity
Opti Optimization
AP Asset Protection
Plan Planning/Study

FY14 CIP Notes
new project, not previously in CIP

Line No	Priority	Project	Project Type	FY14 CIP Project No.	FY14 CIP Contract No.	Project Duration	Cost (\$1000)	Schedule	5 years			10 years			20 years			Total Cost (\$1000)	
									FY14-18	FY19-23	FY24-33	FY34-53	FY14-18	FY19-23	FY24-33	FY34-53	FY14-18		FY19-23
WASTEWATER PUMP STATIONS AND CSO FACILITIES																			
10.01	2	Alewile Brook Pump Station Rehab - Design/CA/Construction	AP	145	10382_6797 10428_7034	5 years	9,926	ongoing-FY18	9,926										9,926
10.02	2	PS and CSOs Condition Assessment for 10 Older Facilities	Plan	145	10446_7162	3 years	3,000	FY15-17	3,000										3,000
10.03	2	PS and CSOs Rehab - Preliminary Design/Study for 6 of 10 Older Facilities	Plan	145	10500_7375	6 years	750	FY16-21	406	344									750
10.04	3	Caruso Pump Station Improvements for Generator Replacement, HVAC and Fire Detection System Replacement - Design and Construction	AP	145	10431_7037 10489_7362	3 years	2,916	ongoing-FY16	2,916										2,916
10.05	3	Chelsea Screen House Upgrades - Design & Construction including Screens and Gates	AP	145	10512_7431	2 years	3,300	FY15-16	3,300										3,300
10.06	2	Prison Point and Cottage Farm CSO Rehab - Preliminary Design/Study	Plan	145	10486_7359	2 years	1,000	FY15-16	1,000										1,000
10.07	2	Prison Point and Cottage Farm Facilities Upgrades including Generators and Prison Point Pump and Gearbox	AP	145	10515_7452	2 years	5,099	FY14-15	5,099										5,099
10.08	3	Cottage Farm Fuel System Upgrade	AP	145	10469_7281	1 year	26	ongoing-FY14	26										26
10.09	2	DeLauri Pump Station Improvements for Electrical Room Cooling and Security Upgrade - Design and Construction	AP	145	10488_7361	2 years	407	FY14-15	407										407
10.10	3	Prison Point HVAC Upgrades - Design and Construction	AP	145	10380_6795	1 year	460	ongoing-FY14	460										460
10.11	3	Prison Point Piping Rehabilitation	AP	145	10518_7459	1 year	331	FY14	331										331
10.12	3	Prison Point Dry Weather Flow and Stripping Pump Improvements	AP	145	10485_7358	3 years	750	FY15-17	750										750
SUBTOTAL - Existing - Pump Stations and CSO Facilities									27,965	344	0	0	0	0	0	0	0	27,965	

Table 10-2
Wastewater Master Plan - Pump Stations and CSO Facilities
Existing and Recommended Projects

Last revision 8/6/13

Line No	Priority	Project	Project Type	FY14 CIP Project No.	FY14 CIP Contract No.	Project Duration	Cost (\$1000)	Schedule	FY14 CIP Notes				Total Cost (\$1000)
									FY14-18	FY19-23	FY24-33	FY34-53	
10.13	3	Facility Emergency Response Plan/Hydraulic Review Project	Plan	new		2 years	500	FY21-23	5 years	500	10 years	20 years	500
10.14	3	Alewite Brook Pump Station Upgrades - Design & Construction	AP	new		5 years	5,000	FY31-35			2,000	3,000	5,000
10.15	3	Canuso Pump Station Upgrades - Design & Construction	AP	new		5 years	25,000	FY19-23		25,000			25,000
10.16	3	Cottage Farm Pumped CSO Upgrades - Design & Construction	AP	new		10 years	20,000	FY19-28		10,000	10,000		20,000
10.17	3	DeLauri Pump Station Upgrades - Design & Construction	AP	new		5 years	25,000	FY19-23		25,000			25,000
10.18	3	Frammingham PS-Force Main Corrosion and Odor Improvements	NF/AP	new		3 years	1,500	FY21-23		1,500			1,500
10.19	2	Frammingham PS-Sluice Gate Replacement Design/Construct	AP	new		2 years	500	FY21-22		500			500
10.20	3	Frammingham PS-Screening Automation Study/Design/Construct	Plan/NF	new		3 years	500	FY21-23		500			500
10.21	3	Hayes Pump Station Upgrades - Design & Construction	AP	new		5 years	12,000	FY21-25		6,000	6,000		12,000
10.22	3	Hingham Pump Station Upgrades - Design & Construction	AP	new		5 years	10,000	FY21-25		5,000	5,000		10,000
10.23	3	Prison Point Pump Station and Pumped CSO Upgrades - Design & Construction	AP	new		10 years	20,000	FY19-28		10,000	10,000		20,000
10.24	3	Somerville Marginal Gravity CSO Upgrades - Design & Construction	AP	new		5 years	5,000	FY21-25		2,000	3,000		5,000
10.25	3	Wiggins-Castle Island Terminal Pump Station Upgrades and Generator Addition - Design & Construction	AP	new		2 years	3,000	FY17-18	3,000				3,000
10.26	3	Long-term Wastewater Facility Asset Protection (for PS & CSO Facilities) \$2M per Year for FY24-53	AP	new		annual	60,000	FY24-53			20,000	40,000	60,000
10.27	4	Future PS and CSO Facility Condition Assessment and Upgrades for 10 Newer Facilities	AP	new		20 years	100,000	FY34-53				100,000	100,000
SUBTOTAL - Recommended - Pump Stations and CSO Facilities							288,000	3,000	86,000	56,000	143,000	288,000	
SUBTOTAL - Existing and Recommended - Pump Stations and CSO Facilities							315,965	30,621	86,344	56,000	143,000	315,965	

CHAPTER 11

COMBINED SEWER OVERFLOW CONTROL PLAN

11.01 Chapter Summary

One major component of MWRA's current CIP is related to the implementation of a long-term plan for control of combined sewer overflows (CSOs). CSOs are discharges of combined wastewater and stormwater flows that exceed the capacity of the sewer system during heavy wet weather events. The CSO long-term control plan is intended to bring CSOs in the metropolitan Boston area into compliance with the Federal Clean Water Act and Massachusetts Surface Water Quality standards in accordance with national and state CSO policies. Development and implementation of the CSO control plan is subject to orders of the Federal District Court for the District of Massachusetts in the matter of *U.S. v. M.D.C. et al., No. 85-0489-RGS* (the "Boston Harbor Case").

The long-term control plan, as mandated by the Federal Court, comprises 35 wastewater system improvement projects that address 84 CSO outfalls. The CSO projects are described in this chapter, including project engineering and construction requirements, schedules, and approved long-term levels of CSO control, i.e. for each outfall, either elimination of discharge, reduced annual frequency and volume of discharge, and/or treatment. The chapter also reviews the status of work to implement the plan, describes the benefits achieved to date, and discusses future activities.

The total cost of the CSO control plan, including both previous and future expenditures, is \$888.1 million. The FY14 CIP includes \$49.4 million of future projected spending in FY14-24. Previous spending for CSO Control Plan projects through FY13 totals \$838.7 million. The \$49.4 million in future spending includes \$5.1 million to complete MWRA managed projects (including CSO planning, technical review, system assessment, easements, etc.) and \$44.3 million to complete community managed projects. Section 11.07 – Summary of Existing CSO Control Plan Capital Projects includes a consolidated list of all projects with remaining funds programmed in the FY14 CIP for FY12-24.

There are no future MWRA or community managed long-term CSO control plan projects recommended for consideration in future CIPs beyond 2020, other than funds budgeted for inspection of North Dorchester Bay outfalls. The Massachusetts Department of Environmental Protection (MassDEP) has issued variances from current water quality standards for the Lower Charles River Basin and for Alewife Brook/Upper Mystic River Basin, allowing certain CSO discharges to continue until such time as MassDEP is able to make long-term water quality standards determinations for these receiving waters. Through an agreement between MWRA and the U.S. Environmental Protection Agency (EPA) and MassDEP, these variances will be extended through 2020, at which time the Massachusetts Surface Water Quality Standards and the level of CSO control for these receiving water will be revisited. Depending on the decisions at that time, additional levels of CSO control beyond 2020 may be required. Additional current and long-term regulatory issues and potential impacts on MWRA are detailed in Chapter 4. Costs for maintenance and future rehabilitation of CSO facilities are included in Chapter 10.

11.02 Overview of Combined Sewer Overflow Control Plan

In 1987, MWRA entered a stipulation in the Federal District Court Order in the Boston Harbor Case by which it accepted responsibility for developing and implementing a long-term CSO control plan for all combined sewer overflows hydraulically connected to MWRA's system, including the outfalls owned and operated by Boston Water and Sewer Commission (BWSC), Cambridge, Chelsea and Somerville (the CSO communities). Under the 1987 Stipulation, MWRA developed a long-term plan to bring Boston area CSOs into compliance with the Federal Clean Water Act and Massachusetts Surface Water Quality Standards. MWRA recommended an extensive set of projects covering a range of control technologies to achieve long-term, site-specific CSO control goals. MWRA presented a conceptual plan of these improvements in 1994 and refined the recommendations in a facilities plan and environmental impact report it issued in 1997. The long-term plan received initial federal and state approvals in early 1998, allowing MWRA to move the projects into design and construction.

As MWRA proceeded with implementation of the projects, it evaluated and recommended several adjustments and additions to the long-term plan in the period 1998 through 2006, responding to regulatory inquiries seeking higher levels of control (e.g. Charles River) and new information that raised concerns about construction requirements, cost or CSO control performance (e.g. North Dorchester Bay, Reserved Channel, East Boston, and Alewife Brook). A final, comprehensive long-term control plan was approved by EPA and MassDEP in March 2006, and on April 27, 2006, Federal District Judge Richard G. Stearns approved a joint motion of the U.S. Department of Justice (DOJ), EPA and MWRA for a comprehensive resolution of outstanding issues related to MWRA's CSO program. Pursuant to the approved motion, MWRA entered a Second CSO Stipulation, which replaced the First Stipulation, in which MWRA agreed to implement 35 CSO control projects and attain levels of CSO discharge frequency and annual volume specific to each of 84 CSO outfalls addressed in the plan. The Second CSO Stipulation states that once MWRA has implemented the recommended plan and demonstrated that it meets the specified levels of control, each CSO community will be solely responsible for the CSOs it owns and operates. As part of the agreement, MassDEP agreed to reissue and EPA agreed to approve five (5) consecutive variances of no more than three years' duration each, through the year 2020, for the Charles River and Alewife Brook/Upper Mystic River that, as applied to the Authority, are consistent with and limited to the requirements in MWRA's long-term CSO control plan set forth in Schedule Seven of the Boston Harbor Case. This agreement provided greater fiscal certainty to MWRA and its ratepayers relative to the scope and cost of the CSO program through 2020.

MWRA's CSO planning efforts were primarily conducted under the System Master Planning phase of the CIP and produced the following components of a broad plan to control CSO discharges and meet water quality standards:

- Through extensive inspections, system monitoring and modeling, MWRA developed a detailed, field-calibrated assessment of its planned collection and treatment system performance in advance of developing a long-term CSO control plan. The performance assessment incorporated major capital investments in the sewer system already underway or planned by MWRA, including upgrades to the transport system, pumping stations, headworks and Deer Island Treatment Plant (DITP). Together with MWRA's and CSO communities' efforts in the late 1980s and 1990s to efficiently operate and maintain their

respective systems, these improvements were shown to effectively maximize the system's capacity to control wet weather flows and markedly reduce CSO discharges system-wide. From 1988 through 1992, total annual CSO discharge predicted for a typical rain year dropped from 3.3 billion gallons to 1.5 billion gallons, with approximately 51 percent of the remaining discharge treated at five MWRA CSO screening/disinfection facilities. The Charles River especially benefited from these improvements.

- In 1993-1994, MWRA presented a System Optimization Plan (SOP), which recommended approximately 160 low cost, easily implemented system modifications to maximize wet weather storage and conveyance. The SOP projects, which were fully implemented by MWRA and the CSO communities by 1997, further reduced CSO discharge by about 20 percent.
- MWRA recommended a large set of projects covering a range of control technologies to achieve site-specific CSO control goals based on site-specific and watershed-based technology assessments and receiving water impacts and uses. MWRA recommended a conceptual plan of these improvements in 1994 and refined the recommendations in a facilities plan and environmental impact report issued in 1997. The long-term plan received initial federal and state approvals in early 1998, allowing MWRA to move the projects into design and construction.
- As MWRA proceeded with implementation of the projects, it evaluated and recommended several adjustments and additions to the long-term plan in the period 1998 through 2006. These adjustments and additions responded to regulatory inquiries seeking higher levels of control for the Charles River Basin and new information that raised concerns about construction requirements, cost, or CSO control performance of several projects in the plan. A final, comprehensive long-term plan, presented in Table 11-1 and Figure 11-1, was approved by EPA and MassDEP and accepted by the Federal Court in 2006. MWRA predicts that the long-term plan will reduce total annual CSO discharge in a typical rainfall year to 0.4 million gallons (an 85 percent reduction from the 1988 level of 3.3 billion gallons), with 93 percent of the remaining discharge to be treated at four screening and disinfection facilities.

As of July 2013, MWRA and its CSO communities had completed 31 of the 35 projects in the plan, two projects were well into construction, and the remaining two projects were in design and scheduled for construction starts in September 2013 and August 2014. With this level of completion, MWRA has achieved significant progress in reducing CSO discharges to Boston Harbor and its tributaries. Together with other major improvements to MWRA's wastewater system, including the upgraded DITP and associated pump stations, the completed CSO projects have reduced the total annual volume of CSO discharge in a typical rainfall year from 3.3 billion gallons in 1988 to 0.5 billion gallons, an 85 percent reduction. In addition, 88 percent of the remaining overflow receives treatment at MWRA's four CSO treatment facilities. December 2015 is the mandated and scheduled completion date for the last of the CSO projects. The Federal Court schedule requires MWRA to commence a three-year performance assessment in January 2018 (approximately two years after the last of the 35 CSO projects is scheduled to be complete) and submit a report assessing attainment of the long-term levels of control by December 2020.

TABLE 11-1
Long-term CSO Control Plan by Receiving Water

Receiving Water	CSO Discharge Goals (typical rainfall year)		Projects*	Capital Cost* (\$ million)
	Activations	Volume (million gallons)		
Alewife Brook/Upper Mystic River	7 untreated and 3 treated @ Somerville Marginal	7.3 3.5	<ul style="list-style-type: none"> • Cambridge/Alewife Sewer Separation • MWR003 Gate and Rindge Siphon Relief • Interceptor Connections/Floatables • Connection/Floatables at Outfall SOM01A • Somerville Baffle Manhole Separation • Cambridge Floatables Control (portion) 	90.8
Mystic River/Chelsea Creek Confluence and Chelsea Creek	4 untreated and 39 treated @ Somerville Marginal	0.6 60.6	<ul style="list-style-type: none"> • Somerville Marginal CSO Facility Upgrade • Hydraulic Relief at BOS017 • Chelsea Trunk Sewer Replacement • Chelsea Branch Sewer Relief • CHE008 Outfall Repairs • East Boston Branch Sewer Relief (portion) 	78.0
Charles River (including Stony Brook and Back Bay Fens)	3 untreated and 2 treated @ Cottage Farm	6.8 6.3	<ul style="list-style-type: none"> • Cottage Farm CSO Facility Upgrade • Stony Brook Sewer Separation • Hydraulic Relief at CAM005 • Cottage Farm Brookline Connection and Inflow Controls • Brookline Sewer Separation • Bulfinch Triangle Sewer Separation • MWRA Outfall Closings and Floatables Control • Cambridge Floatables Control (portion) 	91.1
Inner Harbor	6 untreated and 17 treated @ Prison Point	9.1 243.0	<ul style="list-style-type: none"> • Prison Point CSO Facility Upgrade • Prison Point Optimization • BOS019 Storage Conduit • East Boston Branch Sewer Relief (portion) 	61.8
Fort Point Channel	3 untreated and 17 treated @ Union Park	2.5 71.4	<ul style="list-style-type: none"> • Union Park Treatment Facility • BOS072-073 Sewer Separation and System Optimization • BWSC Floatables Control • Lower Dorchester Brook Sewer Modifications 	62.5
Constitution Beach	Eliminate		<ul style="list-style-type: none"> • Constitution Beach Sewer Separation 	3.8
North Dorchester Bay	Eliminate		<ul style="list-style-type: none"> • N. Dorchester Bay Storage Tunnel and Related Facilities • Pleasure Bay Storm Drain Improvements • Morrissey Blvd Storm Drain 	255.8
Reserved Channel	3 untreated	1.5	<ul style="list-style-type: none"> • Reserved Channel Sewer Separation 	64.8
South Dorchester Bay	Eliminate		<ul style="list-style-type: none"> • Fox Point CSO Facility Upgrade (interim improvement) • Commercial Pt. CSO Facility Upgrade (interim improvement) • South Dorchester Bay Sewer Separation 	126.8
Neponset River	Eliminate		<ul style="list-style-type: none"> • Neponset River Sewer Separation 	2.4
Regional			<ul style="list-style-type: none"> • Planning, Technical Support and Land Acquisition 	50.3
TOTAL		413.3		888.1
Treated		384.8		

*Floatables controls are recommended at remaining outfalls and are included in the listed projects and capital budgets.

FIGURE 11-1
Approved CSO Control Plan and Status of Project Implementation
 (Complete projects in red; remaining projects in green)



The CSO project schedules are driven by milestones for design and construction in Schedule Seven of the Federal Court Order in the Boston Harbor Case. Updated project schedules are presented in Table 11-2. The schedules are aggressive and account for project-specific design, permitting and construction requirements. MWRA, working in cooperation with BWSC, the Town of Brookline and the City of Cambridge, will continue to manage the implementation of

the CSO projects with the goal of controlling project costs, complying with the court schedule milestones, and assuring attainment of the approved long-term levels of CSO control.

TABLE 11-2 CSO Project Schedules

Project (Shading indicates completed project)		Commence Design	Commence Construction	Complete Construction
North Dorchester Bay Storage Tunnel and Related Facilities		Aug 97	Aug 07	May 11
Pleasure Bay Storm Drain Improvements		Sep 04	Sep 05	Mar 06
Hydraulic Relief Projects	CAM005 Relief	Aug 97	Jul 99	May 00
	BOS017 Relief		Jul 99	Aug 00
East Boston Branch Sewer Relief		Mar 00	Mar 03	Jul 10
BOS019 CSO Storage Conduit		Jul 02	Mar 05	Mar 07
Chelsea Relief Sewers	Chelsea Trunk Sewer Relief	Jun 97	Sep 99	Aug 00
	Chelsea Branch Sewer Relief		Dec 99	Jun 01
	CHE008 Outfall Repairs		Dec 99	Jun 01
Union Park Detention/Treatment Facility		Dec 99	Mar 03	Apr 07
CSO Facility Upgrades and MWRA Floatables Control	Cottage Farm Upgrade	Jun 96	Mar 98	Jan 00
	Prison Point Upgrade		May 99	Sep 01
	Commercial Point Upgrade		Nov 99	Sep 01
	Fox Point Upgrade		Nov 99	Sep 01
	Somerville-Marginal Upgrade		Nov 99	Sep 01
	MWRA Floatables Control and Outfall Closings		Mar 99	Mar 00
Brookline Connection and Cottage Farm Overflow Interconnection and Gate		Sep 06	Jun 08	Jun 09
Optimization Study of Prison Point CSO Facility		Mar 06	Mar 07	Apr 08
South Dorchester Bay Sewer Separation		Jun 96	Apr 99	Jun 07
Stony Brook Sewer Separation		Jul 98	Jul 00	Sep 06
Neponset River Sewer Separation			Apr 96	Jun 00
Constitution Beach Sewer Separation		Jan 97	Apr 99	Oct 00
Fort Pt Channel Conduit Sewer Separation and System Optimization		Jul 02	Mar 05	Mar 07
Morrissey Boulevard Storm Drain		Jun 05	Dec 06	Jul 09
Reserved Channel Sewer Separation		Jul 06	May 09	Dec 15
Bulfinch Triangle Sewer Separation		Nov 06	Sep 08	Jul 10
Brookline Sewer Separation		Nov 06	Nov 08	Jul 13
Somerville Baffle Manhole Separation			Apr 96	Dec 96
Cambridge/Alewife Brook Sewer Separation	CAM004 Stormwater Outfall and Detention Basin		Apr 11	Apr 13
	CAM004 Sewer Separation	Jan 97	Jul 98/Sep 12	Dec 15
	CAM400 Manhole Separation	Oct 08	Jan 10	Mar 11
	Interceptor Connection Relief/Floatables Control at Outfalls CAM002, CAM401B and CAM001	Oct 08	Jan 10	Oct 10
	MWR003 Gate and Rindge Ave. Siphon Relief	Mar 12	Aug 14	Oct 15
	Connection Relief/Floatables Control at SOM01A	Mar 12	Sep 13	Jun 14
Region-wide Floatables Control and Outfall Closings		Sep 96	Mar 99	Dec 07

The performance of the sewerage system is constantly improving as CSO and non-CSO projects are completed. Updated assessments of the system’s improving hydraulic performance and updated estimates of CSO discharges based in part on actual field data are essential to verify the predicted benefits of various CSO-related improvements, to recalibrate the system hydraulic model to reflect updated conditions, and to provide up-to-date information to support ongoing long-term goal tracking. MWRA’s NPDES permit and the variances for the Charles River and Alewife Brook/Upper Mystic River require MWRA to estimate CSO discharges at each permitted outfall for all storm events on an annual basis. This is accomplished by MWRA staff utilizing the InfoWorks collection system model and data from permanent and temporary meters in the interceptor system, at CSO treatment facilities, and at or near other CSO outfalls. MWRA’s capital program includes temporary flow metering and other efforts to gather and evaluate new data and track system performance.

11.03 Completed CSO Control Plan Projects

By July 2013, MWRA completed 31 of the 35 projects in the CSO long-term control plan. Highlights of completed projects are described below, generally in order of completion date.

1. SOMERVILLE BAFFLE MANHOLE SEPARATION		
	<p>Receiving Water: Alewife Brook, Upper Mystic River</p> <p>Completed: 1996</p> <p>Capital Cost: \$400,000</p> <p>Description: Separated common manholes connecting local sewer and storm drain systems. City of Somerville performed design and construction with MWRA financial assistance.</p>	<p>CSO Control</p>
	<p>Water Quality Benefit: Eliminated CSO discharges at three City of Somerville outfalls to meet B(CSO Variance) water quality standards.</p> <p>CSO Outfalls: SOM001, SOM006, SOM007</p> <p>Frequency of Discharge (typical year): Before project: 2 With project: Eliminated</p> <p>Annual Discharge Volume (typical year): Before project: 0.04 million gallons With project: Eliminated</p> <p>CSO Reduction by Volume: 100%</p>	

Completed CSO Control Plan Projects (continued)

2. CONSTITUTION BEACH SEWER SEPARATION		
 <p>MWRA decommissioned its Constitution Beach CSO Facility after CSO flows were eliminated by BWSC sewer separation.</p>	<p>Receiving Water: Boston Harbor/Constitution Beach</p> <p>Completed: 2000</p> <p>Capital Cost: \$3,769,000</p> <p>Description: Installed 14,000 linear feet of storm drain to separate the combined sewer system, remove stormwater flows from area sewers, and eliminate CSO discharges to Constitution Beach, allowing MWRA to decommission the Constitution Beach CSO treatment facility.</p>	<p style="text-align: center;">CSO Control</p> <p>Water Quality Benefit: Eliminated CSO discharges to Constitution Beach to meet SB water quality standards.</p> <p>CSO Outfalls: MWR207(BOS002)</p> <p>Frequency of Discharge (typical year): Before project: 16 (treated) With project: Eliminated</p> <p>Annual Discharge Volume (typical year): Before project: 1.35 million gallons With project: Eliminated</p> <p>CSO Reduction by Volume: 100%</p>

3. HYDRAULIC RELIEF AT OUTFALL CAM005		
	<p>Receiving Water: Charles River Basin</p> <p>Completed: 2000</p> <p>Capital Cost: Approx. \$1,147,000</p> <p>Description: In Cambridge, relieved the 40-foot long, 24-inch diameter dry weather connection between the CAM005 regulator and MWRA's North Charles Metropolitan Sewer with a 54-inch additional connection..</p>	<p style="text-align: center;">CSO Control</p> <p>Water Quality Benefit: Minimized CSO discharges to meet B(CSO Variance).</p> <p>CSO Outfalls: CAM005</p> <p>Frequency of Discharge (typical year): Before project: 11 With project: 3</p> <p>Annual Discharge Volume (typical year): Before project: 3.8 million gallons With project: 0.84 million gallons</p> <p>CSO Reduction by Volume: 78%</p>

Completed CSO Control Plan Projects (continued)

4. HYDRAULIC RELIEF AT OUTFALL B0S017		
	<p>Receiving Water: Mystic River/Chelsea Creek Confluence</p> <p>Completed: 2000</p> <p>Capital Cost: Approx. \$1,148,000</p> <p>Description: In Charlestown, installed 190 feet of 36-inch diameter pipe in Sullivan Square to divert two local (BWSC) combined sewers to a direct connection with MWRA's Cambridge Branch Sewer. In addition, eliminated a 10-foot long restriction between the Charlestown and Cambridge Branch Sewers, adjacent to Sullivan Square.</p>	<p style="text-align: center;">CSO Control</p> <p>Water Quality Benefit: Minimized CSO discharges to meet B(CSO) (Mystic R.) water quality standards (>95% compliance with Class B).</p> <p>CSO Outfalls: BOS017</p> <p>Frequency of Discharge (typical year): Before project: 18 With project: 1</p> <p>Annual Discharge Volume (typical year): Before project: 2.5 million gallons With project: 0.02 million gallons</p> <p>CSO Reduction by Volume: 99%</p>

5. NEPONSET RIVER SEWER SEPARATION		
	<p>Receiving Water: Neponset River</p> <p>Completed: 2000</p> <p>Capital Cost: \$2,445,000</p> <p>Description: Installed 8,000 linear feet of storm drain to separate the combined sewer system, remove stormwater flows from area sewers, and close CSO regulators, eliminating CSO discharges at the two remaining CSO outfalls to the Neponset River.</p>	<p style="text-align: center;">CSO Control</p> <p>Water Quality Benefit: Eliminated CSO discharges to Neponset River to meet SB water quality standards and protect South Dorchester Bay beaches (Tenean Beach).</p> <p>CSO Outfalls: BOS093, BOS095</p> <p>Frequency of Discharge (typical year): Before project: 17 With project: Eliminated</p> <p>Annual Discharge Volume (typical year): Before project: 5.8 million gallons With project: Eliminated</p> <p>CSO Reduction by Volume: 100%</p>

Completed CSO Control Plan Projects (continued)

<p>6. CHELSEA TRUNK SEWER REPLACEMENT 7. CHELSEA BRANCH SEWER RELIEF 8. CHE008 OUTFALL REPAIRS</p>		
	<p>Receiving Water: Mystic River/Chelsea Creek Confluence Chelsea Creek</p> <p>Completed: 2000-2001</p> <p>Capital Cost: \$29,778,000</p> <p>Description: Replaced 18-inch diameter city-owned trunk sewer with 30-inch pipe, relieved MWRA's Chelsea Branch and Revere Extension Sewers with 48-inch to 66-inch diameter pipe, rehabilitated Outfall CHE008, and installed underflow baffles for floatables control at all outfalls.</p>	<p>CSO Control</p>
		<p>Water Quality Benefit: Minimized CSO discharges to meet SB(CSO) water quality standards (>95% compliance with Class SB).</p> <p>CSO Outfalls: CHE002, CHE003, CHE004, CHE008</p> <p>Frequency of Discharge (typical year): Before project: 8 With project: 4</p> <p>Annual Discharge Volume (typical year): Before project: 9.0 million gallons With project: 0.6 million gallons</p> <p>CSO Reduction by Volume: 93%</p>

<p>9. UPGRADE COTTAGE FARM CSO FACILITY 10. UPGRADE PRISON POINT CSO FACILITY 11. UPGRADE SOMERVILLE MARGINAL CSO FACILITY 12. UPGRADE FOX POINT CSO FACILITY 13. UPGRADE COMMERCIAL POINT CSO FACILITY</p>		
	<p>Receiving Water: Lower Charles River Basin Upper Inner Harbor Upper Mystic River Mystic River/Chelsea Creek Confluence South Dorchester Bay</p> <p>Completed: 2001</p> <p>Capital Cost: \$22,261,000</p> <p>Description: Upgraded chlorine disinfection systems, added dechlorination systems, process control and safety improvements.</p>	<p>CSO Control</p>
		<p>Water Quality Benefit: Upgrade treatment to comply with B(CSO Variance) (Charles R.) and SB(CSO) water quality criteria, including residual chlorine limits.</p> <p>CSO Outfalls: MWR201 (Cottage Farm Facility) MWR203 (Prison Point Facility) MWR205, MWR205A(SOM007A) (Somerville Marginal Facility) MWR209 (BOS088/BOS089 Fox Point Facility) (decommissioned 2007) MWR211 (BOS090 Commercial Point Facility) (decommissioned 2007)</p> <p>These projects improved treatment performance, with no effect on discharge frequency or volume.</p>

Completed CSO Control Plan Projects (continued)

14. PLEASURE BAY STORM DRAIN IMPROVEMENTS		
	<p>Receiving Water: North Dorchester Bay</p> <p>Completed: 2006</p> <p>Capital Cost: \$3,200,000</p> <p>Description: Constructed a new storm drain system to relocate stormwater discharges from Pleasure Bay to Reserved Channel.</p>	Control
		<p>Water Quality Benefit: Eliminated storm water discharges to Pleasure Bay Beach.</p>

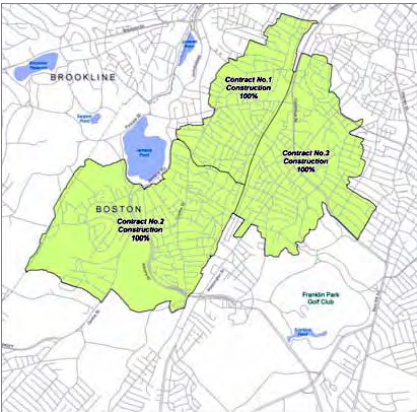
15. STONY BROOK SEWER SEPARATION		
	<p>Receiving Water: Lower Charles River Basin</p> <p>Completed: 2006</p> <p>Capital Cost: \$44,332,000</p> <p>Description: Installed a total of 107,175 linear feet of storm drain and sanitary sewer to remove stormwater from local sewers serving a 609-acre area in Jamaica Plain, Mission Hill and Roxbury, and disconnected an already-separated storm drain system serving an adjacent 548-acre area from the sewer system.</p>	CSO Control
		<p>Water Quality Benefit: Minimized CSO discharges to meet B(CSO Variance water quality standards (Charles R.).</p> <p>CSO Outfalls: MWR023 (Stony Brook Conduit)</p> <p>Frequency of Discharge (typical year): Before project: 22 With project: 2</p> <p>Annual Discharge Volume (typical year): Before project: 44.5 million gallons With project: 0.13 million gallons</p> <p>CSO Reduction by Volume: 99.7%</p>

Completed CSO Control Plan Projects (continued)

16. SOUTH DORCHESTER BAY SEWER SEPARATION		
	<p>Receiving Water: South Dorchester Bay</p> <p>Completed: 2007</p> <p>Capital Cost: \$118,723,000</p> <p>Description: Installed a total of 150,000 linear feet of storm drain and sanitary sewer to remove stormwater from local sewers serving a 1,750-acre area in Dorchester. Closed all CSO regulators, allowing MWRA to decommission its Fox Point and Commercial Point CSO facilities.</p>	<p style="text-align: center;">CSO Control</p> <p>Water Quality Benefit: Eliminated CSO discharges to Savin Hill, Malibu and Tenean beaches, to meet Class SB water quality standards.</p> <p>CSO Outfalls: MWR209 (BOS088/BOS089) MWR211 (BOS090)</p> <p>Frequency of Discharge (typical year): Before project: 20 (treated) With project: Eliminated</p> <p>Annual Discharge Volume (typical year): Before project: 30 million gallons With project: Eliminated</p> <p>CSO Reduction by Volume: 100%</p>

17. FORT POINT CHANNEL SEWER SEPARATION		
	<p>Receiving Water: Fort Point Channel</p> <p>Completed: 2007</p> <p>Capital Cost: \$12,047,000</p> <p>Description: Installed 4,260 feet of storm drain and 4,300 feet of sanitary sewer to remove stormwater from local sewers serving 55 acres in the Fort Point Channel area. Raised overflow weirs at outfalls BOS072 and BOS073. Replaced tide gates and installed underflow baffles for floatables control at both outfalls.</p>	<p style="text-align: center;">CSO Control</p> <p>Water Quality Benefit: Minimizes CSO discharges to meet SB(CSO) water quality standards (>95% compliance with Class SB).</p> <p>CSO Outfalls: BOS072, BOS073</p> <p>Frequency of Discharge (typical year): Before project: 9 With project: 0</p> <p>Annual Discharge Volume (typical year): Before project: 3.0 million gallons With project: 0.0</p> <p>CSO Reduction by Volume: 100%</p>

Completed CSO Control Plan Projects (continued)

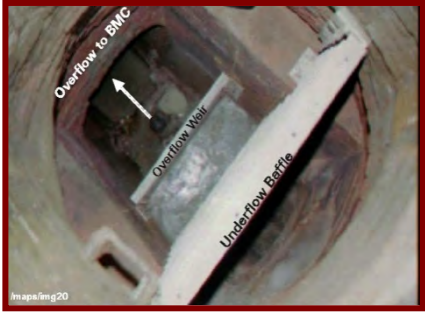
18. REGIONWIDE FLOATABLES CONTROL 19. MWRA FLOATABLES CONTROL AND OUTFALL CLOSING PROJECTS		
	<p>Receiving Water: Region-wide</p> <p>Completed: 2007</p> <p>Capital Cost: \$1,216,000</p> <p>Description: Installed underflow baffles for floatables controls and closed several regulators and outfalls.</p> <p>In March 2000, MWRA closed Outfalls MWR021 and MWR022 to CSO discharges.</p>	<p style="text-align: center;">CSO Control</p> <p>Water Quality Benefit: Complies with EPA Policy Nine Minimum Controls requirement to control solid and floatable material. Eliminated CSO discharges at certain outfalls.</p> <p>CSO Outfalls: Various outfalls system-wide.</p> <p>CSO Control: The floatables controls do not affect CSO discharge frequency or volume.</p>

20. UNION PARK DETENTION/TREATMENT FACILITY		
	<p>Receiving Water: Fort Point Channel</p> <p>Completed: 2007</p> <p>Capital Cost: \$49,584,000</p> <p>Description: Added CSO treatment facility to existing BWSC Union Park Pumping Station with fine screens, chlorine disinfection, dechlorination, and 2 million gallons of detention storage.</p>	<p style="text-align: center;">CSO Control</p> <p>Water Quality Benefit: Provides treatment of Union Park pumping station discharges to Fort Point Channel to meet SB(CSO) water quality criteria, including residual chlorine limits, and lowers discharge frequency and volume with on-site detention basins.</p> <p>CSO Outfall: BOS 070</p> <p>Frequency of Discharge (typical year): Before project: 25 (untreated) With project: 17 (treated)</p> <p>Annual Discharge Volume (typical year): Before project: 132.0 million gallons With project: 71.4 million gallons/year</p> <p>CSO Reduction by Volume: 46%</p>

Completed CSO Control Plan Projects (continued)

21. BOS019 CSO STORAGE CONDUIT		
	<p>Receiving Water: Upper Inner Harbor (Little Mystic Channel)</p> <p>Completed: 2007</p> <p>Capital Cost: \$14,288,000</p> <p>Description: Installed twin-barrel 10'x17' box conduit to provide 670,000 gallons of off-line storage, between Chelsea St. and the Mystic Tobin Bridge, Charlestown. Included above-ground dewatering pump station.</p>	<p style="text-align: center;">CSO Control</p> <p>Water Quality Benefit: Minimized CSO discharges to meet SB(CSO) water quality standards (>95% compliance with Class SB).</p> <p>CSO Outfall: BOS019</p> <p>Frequency of Discharge (typical year): Before project: 13 With project: 2</p> <p>Annual Discharge Volume (typical year): Before project: 4.4 million gallons With project: 0.6 million gallons</p> <p>CSO Reduction by Volume: 86%</p>

22. PRISON POINT CSO FACILITY OPTIMIZATION		
	<p>Receiving Water: Upper Inner Harbor</p> <p>Completed: 2008</p> <p>Capital Cost: \$50,000</p> <p>Description: Minimizes treated CSO discharges to the Inner Harbor by optimizing the operation of existing facility gates and pumps to maximize in-system storage and convey more flow to Deer Island</p>	<p style="text-align: center;">CSO Control</p> <p>Water Quality Benefit: Reduces treated CSO discharges to Upper Inner Harbor to meet SB(CSO) water quality standards.</p> <p>CSO Outfall: MWR203 (Prison Point Facility)</p> <p>Frequency of Discharge (typical year): Before project: 30 (treated) With project: 17 (treated)</p> <p>Annual Discharge Volume (typical year): Before project: 335 million gallons With project: 243 million gallons</p> <p>CSO Reduction by Volume: 27% (with Bulfinch Triangle Sewer Separation)</p>

Completed CSO Control Plan Projects (continued)

23. COTTAGE FARM BROOKLINE CONNECTION AND INFLOW CONTROLS		
 <p>Cottage Farm Brookline Connector</p>	<p>Receiving Water: Lower Charles River Basin</p> <p>Completed: 2009</p> <p>Capital Cost: \$3,186,000</p> <p>Description: Optimizes the combined conveyance capacity of the two MWRA sewers that carry flows across the Charles River by interconnecting overflow chambers outside the Cottage Farm CSO facility; increases this conveyance capacity by bringing into service a parallel, previously unutilized 54-inch diameter sewer (the "Brookline Connection").</p>	<p style="text-align: center;">CSO Control</p> <p>Water Quality Benefit: Minimizes treated CSO discharges from the Cottage Farm CSO Facility to the Lower Charles River Basin to meet B(CSO Variance) water quality standards.</p> <p>CSO Outfall: MWR201 (Cottage Farm Facility)</p> <p>Frequency of discharges (typical year): Before project: 7 (treated) With project: 5 (treated)</p> <p>Annual Discharge Volume (typical year): Before project: 44.5 million gallons With project: 23.0 million gallons</p> <p>CSO Reduction by Volume: 46%</p>

24. MORRISSEY BOULEVARD STORM DRAIN		
	<p>Receiving Water: North Dorchester Bay</p> <p>Completed: 2009</p> <p>Capital Cost: \$32,905,000</p> <p>Description: Installed 2,800 linear feet of 12-foot by 12-foot and 8-foot by 8-foot box conduit for stormwater conveyance, with gated connection to North Dorchester Bay CSO Storage Tunnel at upstream end, new outfall to Savin Hill Cove, and pollution prevention measures.</p>	<p style="text-align: center;">CSO Control</p> <p>Water Quality Benefit: Maximizes level of stormwater control along the South Boston beaches by redirecting some stormwater to Savin Hill Cove in large storms, when CSO and stormwater volume exceeds the South Boston storage tunnel capacity.</p>

Completed CSO Control Plan Projects (continued)

25. EAST BOSTON BRANCH SEWER RELIEF		
	<p>Receiving Water: Boston Harbor and Chelsea Creek</p> <p>Completed: 2010</p> <p>Capital Cost: \$85,706,000</p> <p>Description: Upgraded MWRA's 115-year-old interceptor system serving most of East Boston, using a combination of construction methods: micro-tunneling, pipe-bursting, open-cut excavation and pipe relining.</p>	<p style="text-align: center;">CSO Control</p> <p>Water Quality Benefit: Minimizes CSO discharges to meet SB(CSO) water quality standards (>95% compliance with Class SB).</p> <p>CSO Outfalls: BOS003, BOS004, BOS005, BOS009, BOS010, BOS012, BOS013, BOS014 (BOS006 and BOS007 closed by BWSC)</p> <p>Frequency of discharges (typical year): Before project: 31 With project: 6</p> <p>Annual Discharge Volume (typical year): Before project: 41.0 million gallons With project: 8.6 million gallons</p> <p>CSO Reduction by Volume: 79%</p>

26. BULFINCH TRIANGLE SEWER SEPARATION		
	<p>Receiving Water: Boston Inner Harbor and Lower Charles River Basin</p> <p>Completed: 2010</p> <p>Capital Cost: \$9,986,000</p> <p>Description: Installed a total of 5,290 feet of storm drain and sanitary sewer to remove stormwater from local sewers in a 14-acre area of Bulfinch Triangle/North Station, allowing already-separated storm drains serving an additional 47-acre area of Government Center to be removed from the sewer system, as well. Closed Outfall BOS049 to CSO discharges.</p>	<p style="text-align: center;">CSO Control</p> <p>Water Quality Benefit: Reduces treated CSO discharges from the Prison Point CSO Facility to Boston Upper Inner Harbor to meet Class SB(CSO) water quality standards (Inner Harbor). Eliminated CSO discharges at Outfall BOS049 to meet B(CSO Variance) water quality standards (Charles R.)..</p> <p>CSO Outfalls: MWR203 (Prison Point Facility) and BOS049</p> <p>Frequency of discharges (typical year): Before project: 18 (treated) With project: 17 (treated)</p> <p>Annual Discharge Volume (typical year): Before project: 281.5 million gallons With project: 243.0 million gallons</p> <p>CSO Reduction by Volume: 14%</p>

Completed CSO Control Plan Projects (continued)

27. INTERCEPTOR CONNECTION RELIEF AND FLOATABLES CONTROL AT CAM002 AND CAM401B AND FLOATABLES CONTROL AT CAM001		
	<p>Receiving Water: Alewife Brook</p> <p>Completed: 2010</p> <p>Capital Cost: \$1,207,900</p> <p>Description: Upgraded the hydraulic capacities of City of Cambridge connections to MWRA interceptors and installed underflow baffles for floatables control.</p>	<p style="text-align: center;">CSO Control</p>
<p>CAM 002A & B inlet structure-baffle is visible in front of CAM 002A outlet with a steel plate (temporary condition) bolted on the left hand wall on the CAM 002B outlet.</p>		<p>Water Quality Benefit: Together with other Alewife Brook CSO projects (not yet complete), minimizes CSO discharges to meet B(CSO Variance) water quality standards (98% compliance with Class B).</p> <p>CSO Outfalls: CAM002, CAM401B, CAM001</p>

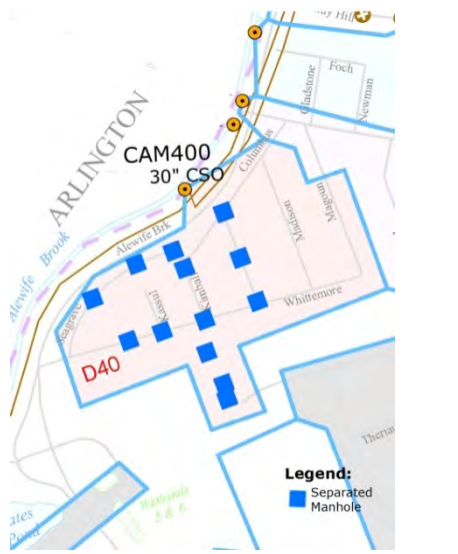
28. CAM400 COMMON MANHOLE SEPARATION		
	<p>Receiving Water: Alewife Brook</p> <p>Completed: March 2011</p> <p>Capital Cost: \$5,434,000</p> <p>Description: Replaced common storm drain and sewer manholes with separate manholes and associated piping in the local, mostly residential streets bounded by Alewife Brook Parkway, Massachusetts Avenue, Magoun Street and Whittemore Avenue, as well as a portion of the WR Grace property off Whittemore Avenue</p>	<p style="text-align: center;">CSO Control</p>
		<p>Water Quality Benefit: Eliminated CSO discharges to Alewife Brook at Outfall CAM400 to comply with B(CSO Variance) water quality standards.</p> <p>CSO Outfalls: CAM400</p> <p>Frequency of Discharge (typical year) Before project: 8 After project: 0</p> <p>Annual Discharge Volume (typical year) Before project: 0.63 million gallon After project: 0</p> <p>CSO Reduction by Volume: 100%</p>

Completed CSO Control Plan Projects (continued)

29. NORTH DORCHESTER BAY STORAGE TUNNEL & RELATED FACILITIES		
 <p>15 mgd Pump Station for Tunnel Dewatering Dewatering Force Main to BMSGC Sewer System Below Ground Ventilation Building 17-Foot Diameter Tunnel Completed Nov 2009 Mortuary Blvd Storm Drain Completed July 2009</p>	<p>Receiving Water: North Dorchester Bay</p> <p>Capital Cost: \$232,567,000 mil</p> <p>Completed: May 2011</p> <p>Description: Constructed a 10,832-ft., 17-ft. diameter soft-ground tunnel, drop shafts and CSO and stormwater diversion structures along outfalls BOS081-BOS087; 15-mgd tunnel dewatering pump station at Massport's Conley Terminal; 24-inch force main; and below-ground tunnel ventilation and odor control facility at the upstream end of the tunnel. Eliminated outfalls BOS083 and BOS087.</p>	<p style="text-align: center;">CSO Control</p> <p>Water Quality Benefit: Eliminated CSO and separate stormwater discharges up to the 25-year storm and 5-year storm, respectively.</p> <p>CSO Outfalls: BOS081 BOS083 BOS085 BOS087 BOS082 BOS084 BOS086</p> <p>Frequency of Discharge (typical year) CSO: Before project: 17 After project: 0 Stormwater: Before project: 93 After project: 0</p> <p>Annual Discharge Volume (typical year) CSO: Before project: 8.6 million gals After project: 0 Stormwater: Before project: 144 million gals After project: 0</p> <p>CSO Reduction by Volume: 100% Stormwater Reduction by Volume: 100%</p>

30. CAM004 Stormwater Outfall and Wetland Basin		
 <p>Rendering of Stormwater Wetland at Alewife Brook, Cambridge</p>	<p>Receiving Water: Alewife Brook</p> <p>Completed: 2013</p> <p>Capital Cost (MWRA share): \$12,200,000</p> <p>Description: Installed 3,300 linear feet of 4-foot by 8-foot storm drain box conduit and created a 3.4-acre wetland to provide for the conveyance, detention and wetland treatment of stormwater that will be separated from the Cambridge sewer system in areas tributary to Outfall CAM004.</p>	<p style="text-align: center;">CSO Control</p> <p>Water Quality Benefit: Allows for the closing of Outfall CAM004 under the CAM004 sewer separation project and reduction of CSO at other Alewife Brook outfalls. Mitigates the potential for flooding and pollution impacts of separated stormwater flows in the Little River and Alewife Brook.</p> <p>CSO Outfalls: CAM004</p> <p>CSO Control: supports the CSO control benefits of the CAM004 sewer separation project.</p>

Completed CSO Control Plan Projects (continued)

31. BROOKLINE SEWER SEPARATION		
	<p>Receiving Water: Charles River Basin</p> <p>Completed: 2013</p> <p>Capital Cost: \$25,977,000</p> <p>Description: Installed a total of 15,300 feet of storm drain and sanitary sewer to remove stormwater from local sewers in a 72-acre area in the Town of Brookline that was served by combined sewers. Cleaned Outfall MWR010 to accommodate the conveyance of separated stormwater to the Charles River.</p>	<p style="text-align: center;">CSO Control</p> <p>Water Quality Benefit: Reduces treated CSO from the Cottage Farm CSO Facility to the Charles River Basin and reduces untreated CSO at Outfall MWR010 and other Charles River outfalls.</p> <p>CSO Outfalls: MWR201 (Cottage Facility) and MWR010</p> <p>CSO Control: primarily supports the attainment of long-term levels of CSO control at the Cottage Farm Facility.</p>

11.04 Ongoing CSO Control Plan Projects

Four of the 35 projects in the CSO long-term control plan are not complete, and their implementation is ongoing. Summary descriptions of these projects are presented in this Section.

Reserved Channel Sewer Separation

The \$64.8 million Reserved Channel Sewer Separation project (see Figure 11-2) is intended to minimize CSO discharges and impacts to the Reserved Channel by separating combined sewer systems in a portion of South Boston tributary to CSO Outfalls BOS076, BOS078, BOS079 and BOS080. Implementation of the approved sewer separation plan is predicted to reduce the number of CSO activations to the Reserved Channel from 37 events to three events in a typical year and reduce total annual CSO volume to the Reserved Channel from 28 million gallons to 1.5 million gallons. The work includes the installation of approximately 42,100 linear feet of new storm drain, along with an additional 6,500 feet of minor drain primarily to connect catch basins to the new storm drains. The work also includes the installation or rehabilitation of 17,300 linear feet of sanitary sewer. To remove enough stormwater inflow from the sewer system and attain the long-term level of CSO control, many building downspout connections and parking lot drains will also be disconnected from the sewer and tied into the new storm drains. The project also includes rehabilitating and/or upgrading the four CSO outfalls to ensure they have the capacity to deliver the separated stormwater flows, as well as remaining, infrequent CSO flows, to the Reserved Channel for the long term.

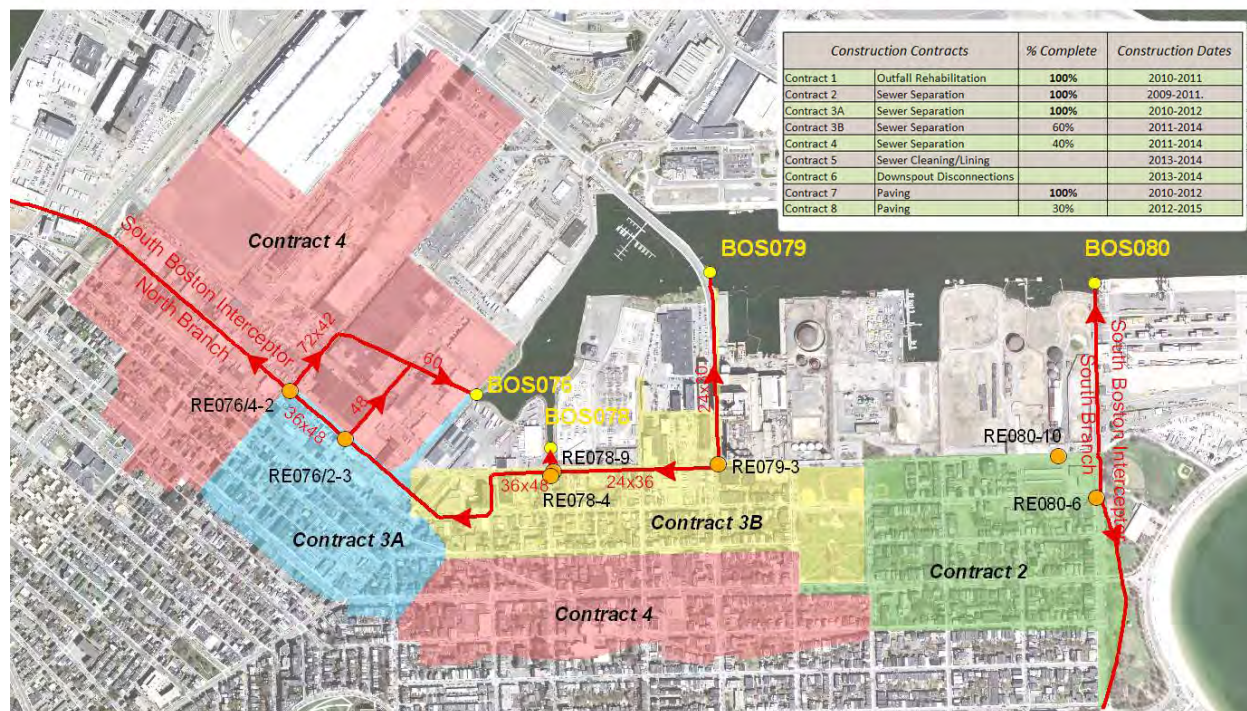
FIGURE 11-2**Reserved Channel Sewer Separation**

The project area encompasses approximately 365 acres of South Boston that comprise the drainage areas tributary to the four Reserved Channel outfalls. This area is an urban mix of residential properties and extensive commercial, industrial and recreational land uses primarily along or close to the channel. East First Street is the primary roadway through the project area and is characterized by heavily congested utilities and truck traffic primarily associated with transportation of containers from Conley Terminal.

MWRA and BWSC added this project to their CSO Memorandum of Understanding and Financial Assistance Agreement in June 2006. BWSC is responsible for managing design and construction of the project and ensuring that CSO control goals and other project objectives are met. BWSC will own the new storm drains and upgraded sewers. MWRA is funding design and construction costs pursuant to the eligibility terms of the agreement. BWSC commenced design in July 2006 and the first construction contract (BWSC Contract 2) in May 2009, in compliance with Schedule Seven. The design work and construction contracts for the Reserved Channel sewer separation project follow an approach similar to the completed South Dorchester Bay and Stony Brook sewer separation projects, with multiple design packages and construction contracts sequenced over several years. BWSC proposes nine, phased construction contracts for this project, including four sewer separation contracts (BWSC Contracts 2, 3A, 3B, and 4), an outfall rehabilitation contract (BWSC Contract 1), a sewer cleaning and lining contract (BWSC Contract 5), a downspout disconnection contract (BWSC Contract 6), and two final paving contracts (BWSC Contracts 7 and 8). The FY14 CIP budget for the estimated MWRA-eligible cost of the project is \$64.8 million, with \$4.7 million remaining to be funded by MWRA during FY14-16.

BWSC has made substantial progress with design and construction of the project.

- In October 2010, BWSC attained substantial completion of the \$5.9 million first construction contract (Contract 2), which involved the installation of 8,379 linear feet of storm drain, approximately 3,961 linear feet of minor drain, and 3,372 linear feet of sanitary sewer to separate combined sewers in a 55-acre area of South Boston approximately bounded by East First Street, Farragut Road, East Fourth Street and N Street.
- In December 2011, BWSC attained substantial completion of the \$4.2 million second construction contract (Contract 1), which included the rehabilitation of the four Reserved Channel CSO outfalls to accommodate the stormwater flows being removed from the sewer system, provide long-term structural integrity, and protect the Reserved Channel shoreline at each discharge location.
- In April 2012, BWSC completed the \$1.1 million Contract 7 for pavement restoration.
- In December 2012, BWSC completed the \$10.2 million Contract 3A, which involved sewer separation in a 33-acre area tributary to CSO Outfall BOS076. Contract 3A included the installation of 9,000 linear feet of storm drain, 3,375 linear feet of sanitary sewer, 8,650 linear feet of replacement water main to avoid conflicts with the planned storm drains, and 22 new storm drain catch basins, as well as the reconnection of 76 existing catch basins from the existing sewer system to the new storm drains.
- The \$10.8 million Contract 3B, which involves sewer separation in two areas tributary to outfalls BOS078 and BOS079 totaling 66 acres, was 80 percent complete as of September 2013. Contract 3B consists of the installation of 10,730 linear feet of storm drain, 4,240 linear feet of sanitary sewer, 10,900 linear feet of replacement water main to remove conflicts with the planned storm drains, and 14 new storm drain catch basins, as well as the reconnection of 120 existing catch basins from the existing sewer system to the new storm drains. BWSC expects to attain substantial completion of Contract 3B in October 2014.
- The \$9.1 million Contract 4, which is the last of the major Reserved Channel sewer separation contracts, was 70 percent complete as of September 2013. Contract 4 involves sewer separation in two areas totaling 182 acres tributary to outfalls BOS076, BOS078 and BOS079. BWSC plans to commence construction of Contract 4 in September 2012 and complete the work by June 2015. BWSC expects to attain substantial completion of Contract in August 2015.
- BWSC awarded its \$6.8 million Contract 8 (pavement restoration 2) in April 2012. Contract 8 includes roadway resurfacing associated with sewer separation contracts 3B and 4.
- BWSC continues with the design of the remaining contracts – Contract 5 (existing sewer cleaning and lining) and Contract 6 (downspout disconnections) – which it plans to commence during 2013.

BWSC plans to complete all work for the Reserved Channel sewer separation project by December 2015, in compliance with Schedule Seven.

Alewife Brook CSO Control Plan

The Alewife Brook CSO Control plan projects include CAM004 Outfall and Detention Basin; CAM004 Sewer Separation; CAM400 Manhole Separation; Interceptor Connection Relief/Floatables at Outfalls CAM002 and CAM401B and Floatables Control at CAM001; Outfall MWR003 Gate and Rindge Avenue Siphon Relief; and Interceptor Connection Relief and Floatables Control at Outfall SOM01A. These projects, shown in Figure 11-3, are intended to minimize CSO flows to Alewife Brook, primarily by separating combined sewer systems in parts of Cambridge and upgrading connections between the Cambridge and MWRA systems.

With the exception of the MWR003, Rindge Avenue Siphon and SOM01A work, the projects are being implemented by the City of Cambridge with MWRA funding under the CSO Memorandum of Understanding and Financial Assistance Agreement. In July 1998, Cambridge began construction of the CAM004 sewer separation project recommended in the 1997 Facilities Plan/EIR. The work already completed has significantly reduced CSO discharges to Alewife Brook. Hydraulic model simulations show that the construction completed to date has reduced CSO discharges to Alewife Brook from 63 times per year on average with 50 million gallons annual volume to 25 times per year on average with 33 million gallons annual volume. Improvements made in 2008 to the operation of pumps at MWRA's Alewife Brook Pump Station further reduced CSO discharges to 22 activations and 26.5 million gallons in a typical rainfall year. With work completed by the City of Cambridge in 2010 and 2011 and with an upgrading of MWRA's sewer system model in 2012, MWRA's estimate of average annual CSO discharge to Alewife Brook at the end of 2012 is 10 activations and 14 million gallons.

The discovery in 2000 of previously unknown system conditions necessitated a reevaluation of CSO control options for this area. MWRA and the City of Cambridge developed a revised control plan for Alewife Brook, which was presented in MWRA's Final Variance Report for Alewife Brook and the Upper Mystic River, dated July 2003. The revised plan for Alewife Brook includes six projects that include sewer separation to close outfalls CAM400 and CAM004; construction of a new storm drain outfall and wetland detention basin to manage the separated stormwater flows; relief of interceptor connections; floatables controls; construction of an overflow control gate at outfall MWR003; and relief of MWRA's Rindge Avenue Siphon. Completion of these projects will reduce the frequency of CSO discharges to Alewife Brook in a typical rainfall year to seven activations, and will reduce average annual volume of CSO discharge to Alewife Brook to 7.3 million gallons (an 85 percent reduction by volume). The total estimated cost of the six projects, including MWRA and City of Cambridge shares but not including non-CSO related improvements to Cambridge's infrastructure (in-eligible for MWRA funding) is \$112 million. The FY14 CIP budget for MWRA's total cost share, not including the two projects that will be implemented by MWRA that are described in more detail below, is \$86.9 million, with \$35.3 million remaining to be funded by MWRA during FY14-16.

Implementation of the Alewife projects in the revised recommended plan was delayed for several years by citizen appeals of the wetlands permit for the CAM004 wetland (detention) basin proposed to be constructed in the Department of Conservation and Recreation's (DCR) Alewife Brook Reservation. The appeals were resolved in 2007, and Cambridge has since made considerable design and construction progress, including:

**FIGURE 11-3
Alewife Brook CSO Control Plan (1 of 2)**

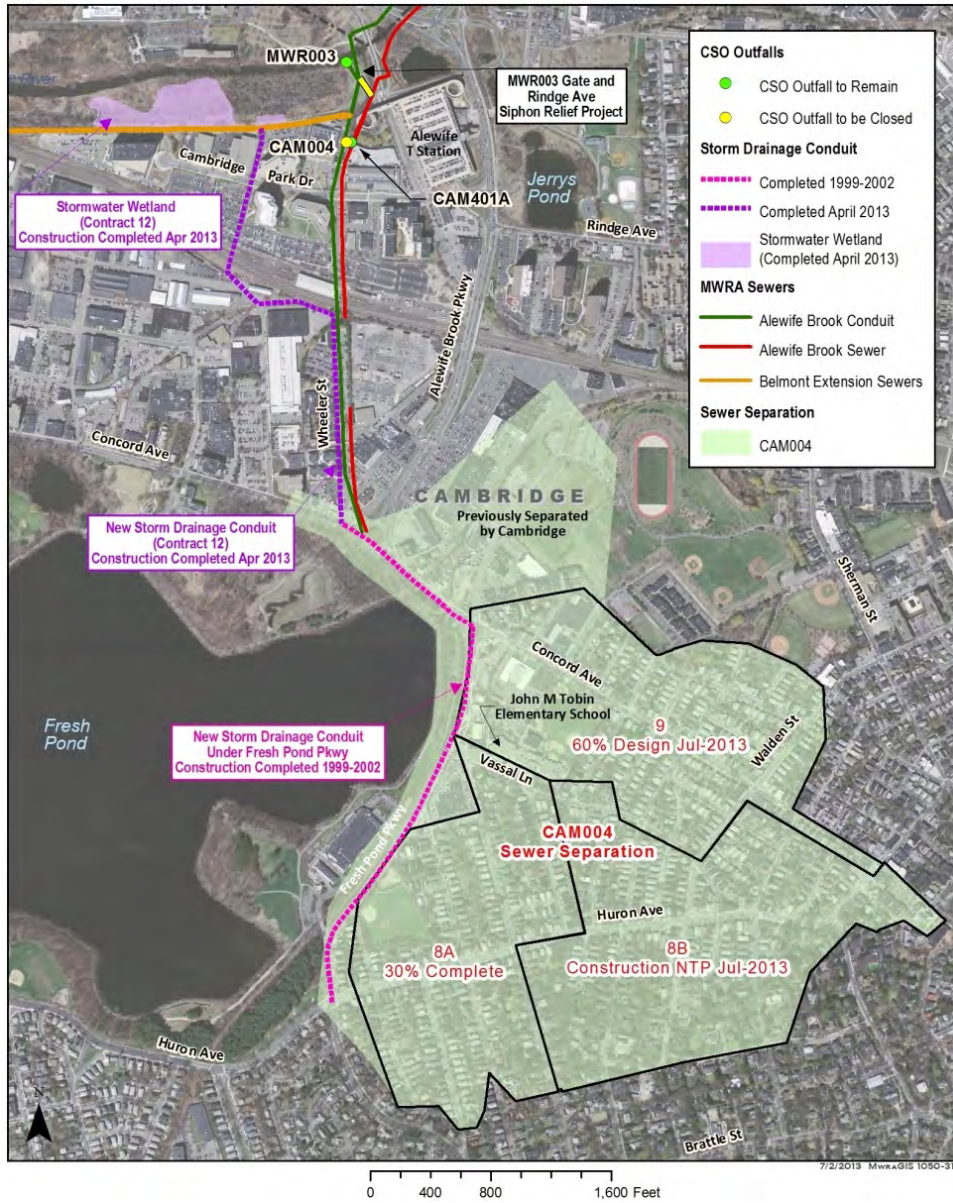

Alewife Brook CSO Control Plan (2 of 2)

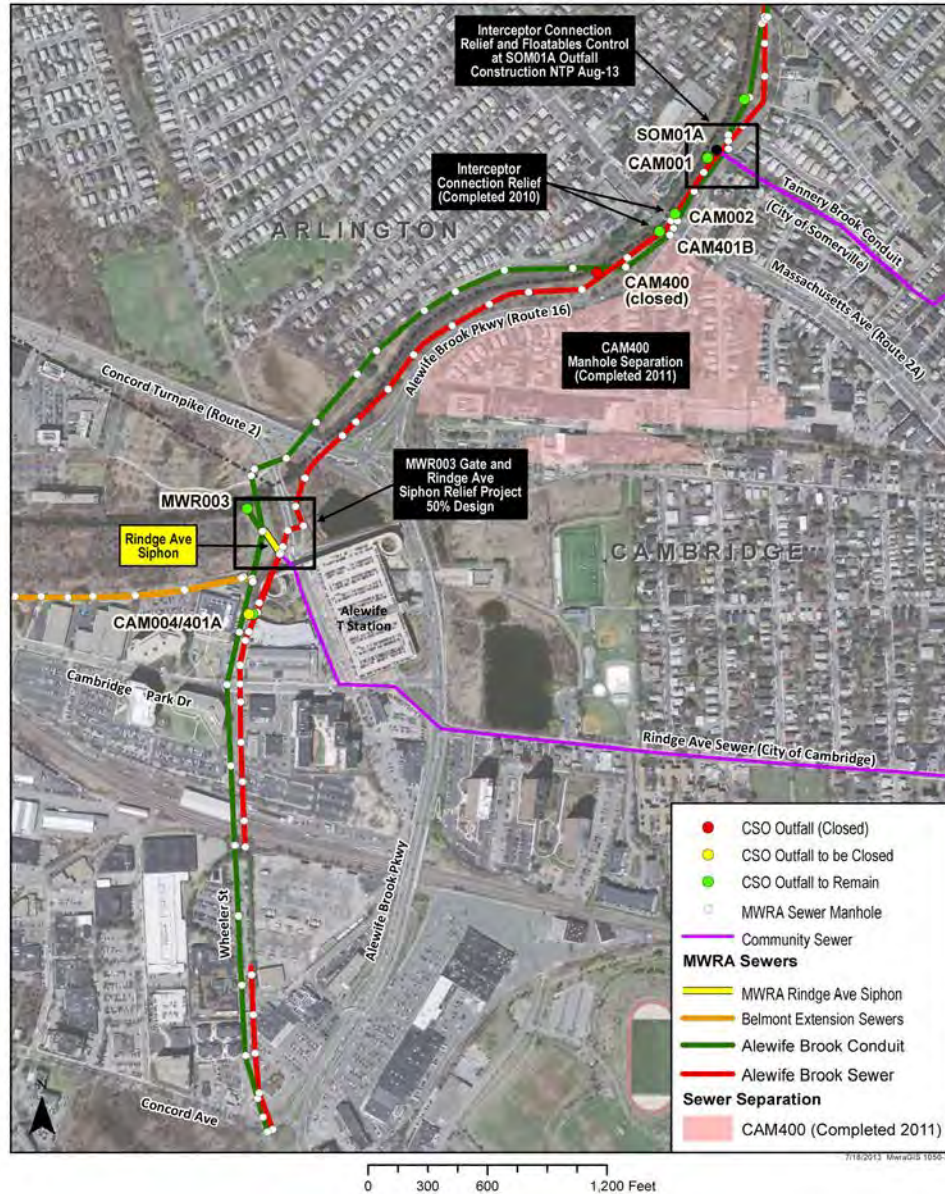

- Completion of the Interceptor Connection Relief/Floatables Controls at CAM002 and CAM401B and Floatables Control at CAM001 project in October 2010.
- Completion of the CAM400 Manhole Separation project in March 2011.
- Completion of the CAM004 stormwater outfall and wetland basin in April 2013.
- Progress with final design and construction of the CAM004 Sewer Separation project as of September 2013, including 65 percent completion of construction of Contract 8A, commencement of construction of Contract 8B in September 2013, and 90 percent design of Contract 9. Cambridge expects to complete all work by December 2015, in compliance with Schedule Seven.

Improvements at Outfall MWR003, Rindge Avenue Siphon and Outfall SOM01A

While most of the revised Alewife Brook CSO control plan is being implemented by the City of Cambridge with MWRA financial assistance, two of the six projects will be designed and constructed by MWRA. This work is shown in Figure 11-4. One recommended project includes installation of an automated hydraulic relief gate and associated controls at the overflow weir associated with outfall MWR003, provision of floatables control for this outfall, and relief of a 30-inch MWRA siphon that conveys overflows to Outfall MWR003 from two MWRA interceptors. MWRA's interceptors (the Alewife Brook Sewer and the Alewife Brook Conduit) parallel Alewife Brook and convey wastewater from parts of Belmont, Arlington, Cambridge and Somerville. A second project implemented by MWRA includes enlargement of the connection between the City of Somerville's Tannery Brook Conduit (Outfall SOM01A) and MWRA's Alewife Brook Conduit and provision of floatables control utilizing an underflow baffle that is proposed to be located between the connection and the end of the outfall.

The estimated cost of the projects programmed in the FY14 CIP is \$4.0 million during FY12-17. MWRA commenced a design contract for both the MWR003 gate and Rindge Avenue siphon project and the SOM01A interceptor connection relief and floatables control project in March 2012 and plans to complete construction of the projects by October 2015 and June 2014, respectively, in compliance with Schedule Seven. MWRA issued the Notice to Proceed with construction of the SOM01A project on August 30, 2013.

FIGURE 11-4

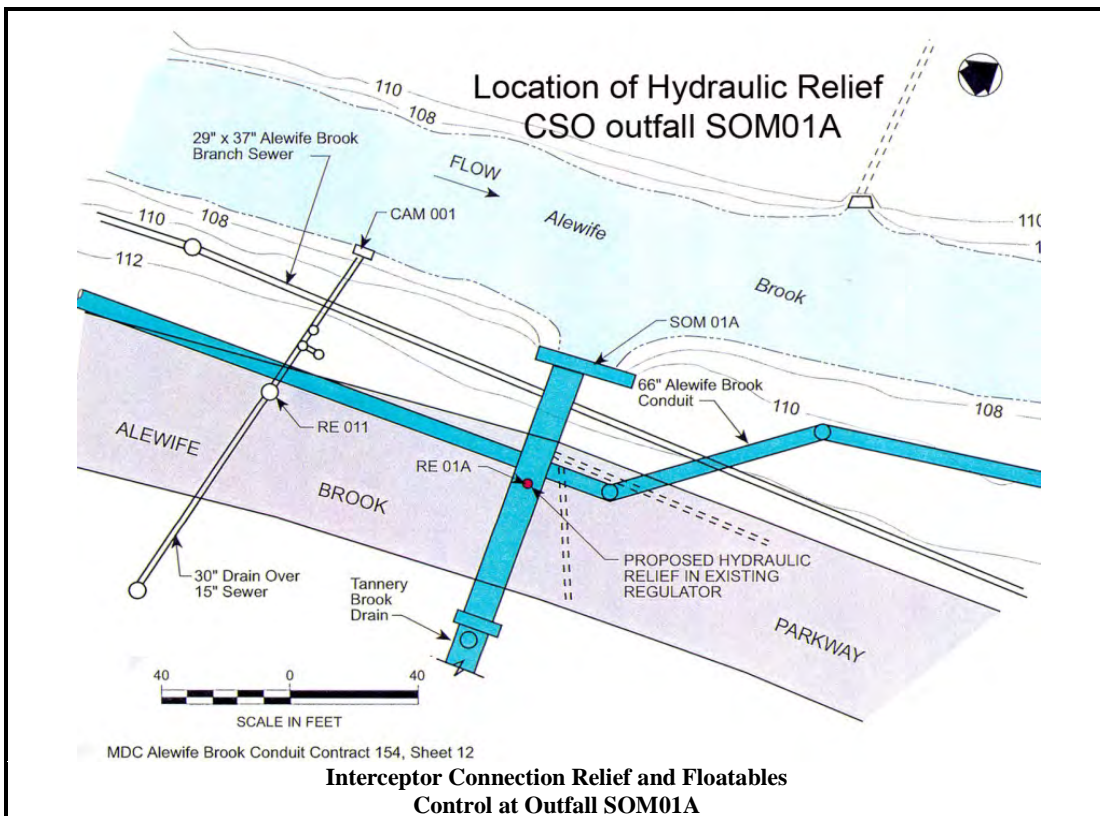
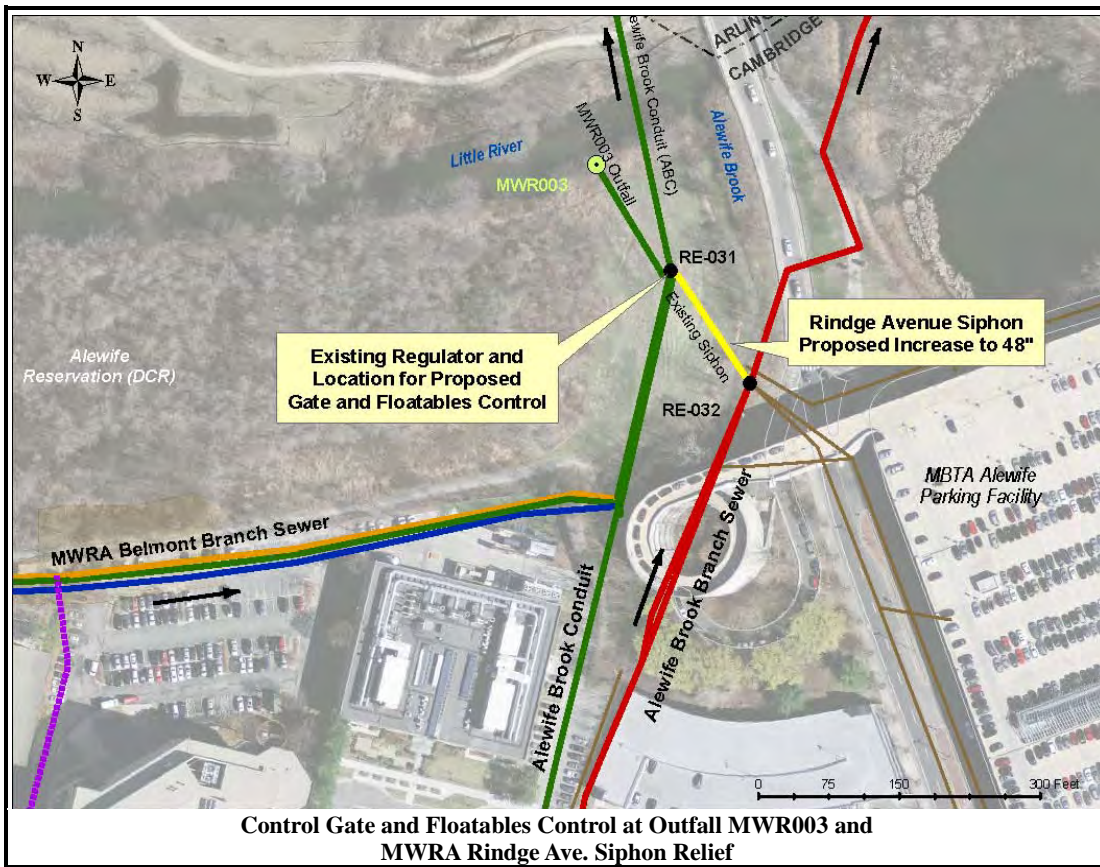

11.05 Future Staffing and Operation and Maintenance Cost Impacts from the CSO Control Plan

Implementation of MWRA managed projects within the long-term CSO control plan has incremental staffing and annual operation and maintenance (O&M) cost impacts, as presented in Table 11-3, below. All staffing and O&M cost impacts associated with any community implemented CSO project will be borne by the respective community, i.e. BWSC, the City of Cambridge and the Town of Brookline.

**TABLE 11-3
Staffing and O&M Cost Impacts of Existing CSO Projects**

CSO Project	Startup	Staffing Impact (FTE)	Annual O&M Cost (including staffing)
Union Park Detention/Treatment Facility	Dec 06	0*	\$ 897,000
Prison Point CSO Facility Optimization	Mar 07	0	0
BOS019 CSO Storage Conduit	Mar 07	0	50,000
Brookline Connection and Cottage Farm Overflow Interconnection/Gate	Jun 09	0	0
East Boston Branch Sewer Relief	Jul 10	0	0
MWR003 Gate and Rindge Ave. Siphon Relief	Oct 15	0	0
North Dorchester Bay Storage Tunnel and Related Facilities	May 11	0	400,000
TOTAL		0	\$1,347,000

* MWRA and BWSC jointly contract for operations and maintenance of the Union Park Detention/Treatment Facility.

11.06 Future Capital Improvement Project Needs for the CSO Control Plan

No additional capital projects are anticipated to be needed for CSO control, through 2020. The Federal Court's substitution of the First CSO Stipulation, dated February 27, 1987, with the Second CSO Stipulation on April 27, 2006, afforded MWRA and its ratepayers an assurance that the long-term CSO control plan recommended by MWRA will meet federal and state requirements at least through 2020. Beyond 2020, higher levels of control and associated additional capital investments may be required by long-term water quality standard determinations MassDEP is scheduled to issue relative to the variances for the Lower Charles River Basin and the Alewife Brook/Upper Mystic River. Also, if in 2020 when MWRA completes the required CSO performance assessment, it determines that the approved long-term levels of control have not been attained at any outfall, MWRA may be obligated and may be required to implement additional controls to bring the discharges into conformance with the plan goals at MWRA and/or community outfalls.

Other regulatory decisions could require MWRA to develop and implement additional capital improvements to increase the level of control of CSO discharges beyond the levels in the approved long-term control plan, but only for outfalls it owns and operates. This outlook assumes that the required CSO control performance levels recommended in the long-term plan are met with the recommended projects described in this Chapter.

Federal and state regulations governing CSO discharges may evolve prior to or after 2020. MWRA, through staff reviews or through its participation in the National Association of Clean Water Agencies, will stay informed and have input into regulatory discussions, both formally and informally. Additional current and long-term regulatory issues and potential impacts on MWRA are detailed in Chapter 4.

MassDEP is required to review water quality standards every three years (but in fact the reviews are less frequent). Its reviews, which must include public comment, take into account new information regarding the effects of discharges and the feasibility of attaining existing or higher water quality standards. MWRA does not expect that these reviews will change either the assessment of CSO impacts or the appropriate and feasible level of CSO control, at least through the MWRA CSO assessment period ending in 2020.

11.07 Summary of Existing CSO Control Plan Capital Projects

The total cost of the CSO Control Plan (including both previous and future expenditures) is programmed in the FY14 CIP at a cost of \$888.1 million. The FY14 CIP includes \$49.4 million of projected spending in FY14 and beyond, as well as, \$838.7 million in previous spending through FY13. The \$49.4 million planned to be spent in FY14 and beyond includes \$5.1 million to complete or close out three MWRA managed projects and \$44.3 million to complete or close out seven community managed projects. All MWRA and community managed CSO control projects with CIP spending in FY14 and beyond are summarized in the bullets below and in Table 11-4. There are no future MWRA or community managed CSO Control Plan projects recommended for consideration in future CIPs beyond 2020.

- North Dorchester Bay total to project completion and close-out including engineering, construction services, construction and outfall inspection is programmed in the FY14 CIP at \$1.120 million remaining to be spent during FY14-24. The project was substantially complete in May 2011 and is online and fully operational. Additional work to complete outfall inspections and related engineering services will be ongoing through FY24.
- MWR003 Gate and Siphon and SOM01A Relief design and construction 1 and 2 is programmed in the FY14 CIP at \$3.278 million to be spent during FY14-17.
- CSO Planning and Support Services including easements, permits, system assessment, and technical review is programmed in the FY14 CIP at \$706,000 remaining to be spent during FY14-20.
- Dorchester Bay Sewer Separation (Fox Point) design and construction is programmed in the FY14 CIP at \$16,000 remaining to be spent during FY14-15.

- Dorchester Bay Sewer Separation (Commercial Point) design and construction is programmed in the FY14 CIP at \$3.628 million remaining to be spent during FY14-16.
- Cambridge 02-04 Sewer Separation (Alewife) design and construction is programmed in the FY14 CIP at \$35.349 million remaining to be spent during FY14-16.
- Morrissey Boulevard Drain design and construction is programmed in the FY14 CIP at \$468,000 remaining during FY14-15.
- Reserved Channel Sewer Separation design and construction is programmed in the FY14 CIP at \$4,769 million remaining to be spent during FY14-16.
- Brookline Sewer Separation design and reimbursement of construction funds previously transferred is programmed in the FY14 CIP at net revenue of \$20,000 remaining during FY14-15.
- Bulfinch Triangle Sewer Separation design is programmed in the FY14 CIP at \$86,000 remaining to be spent during FY14-15.

Table 11-4
Wastewater Master Plan - CSO Control Plan - MWRA and Community Managed Projects
Existing Projects

Last revision 8/6/13

Project Types
 NF New Facility/System
 RF/IC Replacement Facility/Increase Capacity
 Opti Optimization
 AP Asset Protection
 Plan Planning/Study
 NF/C New Facility/Community-Owned

FY14 CIP Notes
 new project, not previously in CIP

Prioritization
 1 Critical
 2 Essential
 3 Necessary
 4 Important
 5 Desirable

Line No	Priority	Project	Project Type	FY14 CIP Project No.	FY14 CIP Contract No.	Project Duration	Cost (\$1000)	Schedule	5 years				Total Cost (\$1000)
									FY14-18	FY19-23	FY24-33	FY34-53	
CSO CONTROL PLAN - (MWRA managed projects)													
11.01	1	North Dorchester Bay Total to Project Completion - Engineering, Construction Services, Construction and Outfall Inspection	NF	339	multi-phase	11 years	1,120	ongoing-FY24	807	250	63		1,120
11.02	1	MWRA003 Gate & Siphon and SOM01A Relief- Design and Construction 1 and 2	NF/IC	355	32722_6952 32723_6953 32755_7409	4 years	3,278	ongoing-FY17	3,278				3,278
11.03	1	CSO Planning & Support - SOP Program, Easements, System Assessment and Tech Review	Plan	324	32658_6169 32691_6372 32648_6150	7 years	706	ongoing-FY20	(315)	1,021			706
SUBTOTAL - CSO Control Plan (MWRA Managed)							5,104		3,770	1,271	63		5,104
CSO CONTROL PLAN (Community managed projects)													
11.04	1	Dorchester Bay Sewer Separation (Fox Point) - Design and Construction	NF/C	340	32651_6155 32664_6247	1 year	16	ongoing-FY15	16				16
11.05	1	Dorchester Bay Sewer Separation (Commercial Point) - Design and Construction	NF/C	341	32650_6154 32665_6248	3 years	3,628	ongoing-FY16	3,628				3,628
11.06	1	Cambridge 02-04 Sewer Separation (Alewife) - Design and Construction	NF/C	346	32654_6161 32672_6255	3 years	35,349	ongoing-FY16	35,349				35,349
11.07	1	Morrissey Boulevard Drain - Design and Reimbursement of Construction Funds Transferred	NF/C	358	32713_6686 32735_7015	2 years	468	ongoing-FY15	468				468
11.08	1	Resealed Channel Sewer Separation - Design and Construction	NF/C	359	32734_7014 32727_6994	3 years	4,769	ongoing-FY16	4,769				4,769
11.09	1	Brookline Sewer Separation - Design and Construction	NF/C	360	32736_7076 32737_7077	1 year	(20)	ongoing-FY15	(20)				(20)
11.10	1	Bullfinch Triangle Sewer Separation - Design	NF/C	361	32738_7078	1 year	86	ongoing-FY15	86				86
SUBTOTAL - CSO Control Plan (Comm Managed)							44,296		44,296				44,296
TOTAL - CSO Control Plan (MWRA & Comm Managed)									48,066	1,271	63		49,400

CHAPTER 12

SUPERVISORY CONTROL AND DATA ACQUISITION (SCADA) AND WASTEWATER METERING SYSTEM

12.01 Chapter Summary

Supervisory Control and Data Acquisition (SCADA) systems provide a means of monitoring and controlling facilities and equipment from a remote centralized location, as well as providing a continuous record of facility operations. MWRA's Wastewater SCADA system went through a major upgrade from 2007 through 2009 as part of the Wastewater Central Monitoring/SCADA Implementation Project. This project created a unified SCADA system covering all significant wastewater facilities. New facilities such as the North Dorchester Bay CSO Storage and Pump Facilities have been incorporated into the system. All wastewater facilities can be monitored and controlled at the Chelsea Operations Control Center using the SCADA system.

MWRA's wastewater metering system provides rate-basis data on community flows, as well as additional operational support data for hydraulic modeling, capacity analyses, engineering studies, and community flow component (sanitary/infiltration/inflow) estimates. Upgrades to the wastewater metering system are scheduled to continue throughout the 40-year Master Plan period.

The existing MWRA SCADA and wastewater metering equipment are in good condition. Future needs identified in the Master Plan are based on assumed useful life/obsolescence of the electronic equipment. Wastewater SCADA related personal computer (PC) upgrades are expected every 5 years so that the PCs will continue to be able to support the desired operating systems. Wastewater SCADA programmable logic controller (PLC) equipment and communication equipment are expected to need replacement or upgrade every 20 years or when a significant enhancement in security architecture is released. Wastewater metering system equipment is expected to need replacement about every 10 years.

For SCADA improvements and wastewater metering system upgrades, \$42.480 million in projects is identified in the 40-year master plan timeframe (FY14-53). Near-term, mid-term and long-term costs are detailed below. Section 12.05 - Summary of Existing and Recommended Capital Projects includes a consolidated listing of all projects recommended in this Chapter.

Near-term (FY14-18):

- \$9.805 million is programmed in the FY14 CIP:
 - \$700,000 for wastewater central monitoring - wastewater redundant communications;
 - \$300,000 for wastewater metering system equipment replacement planning/study, and design;
 - \$1.0 million for wastewater metering system equipment replacement construction; and,
 - \$4.231 million to begin the wastewater metering system equipment replacement asset protection/equipment purchase project.

Mid-term (FY19-23):

- \$7.692 million is programmed in the FY14 CIP to continue the wastewater metering system equipment replacement asset protection/equipment purchase project.
- \$240,000 is recommended for consideration in future CIPs for wastewater microwave radio replacement during FY22-23.

Long-term (FY24-33 and FY34-53):

- \$8.077 million is programmed in the FY14 CIP to complete the wastewater metering system equipment replacement asset protection/equipment purchase project.
- \$20.24 million in needs is recommended for consideration in future CIPs:
 - \$5.0 million for FY24-33 and \$5.0 million for FY34-53 for wastewater SCADA equipment (PLC) replacement/upgrades;
 - \$240,000 during FY42-43 for wastewater microwave radio replacements; and,
 - \$10.0 million for FY34-53 (\$5.0 million every 10 years estimated to begin in FY34 and FY44) for wastewater metering system asset protection planning, design, and construction.

12.02 SCADA System Overview

SCADA systems provide a means of monitoring and controlling facilities and equipment from a remote centralized location, as well as providing a continuous record of facility operations. SCADA systems are common in municipal and industrial applications and typically consist of four primary components:

- Field instruments and equipment (e.g., sewage level sensors, valve actuators);
- Input/Output (I/O) devices (e.g., programmable logic controllers (PLCs) that handle data and command signals to and from field equipment);
- Communication devices and media (e.g., telephone lines, radio links); and,
- Host computer [e.g., personal computers that support the data management and user interface software known as a Human Machine Interface (HMI)].

The goals established in the 1999 SCADA Master Plan are still relevant. They include the following primary and secondary goals:

Primary Goals

- Reduce Transport Operations and Maintenance Costs;
- Operate the Transport System More Efficiently;
- Enhance the Reliability and Performance of Transport System Operations; and,
- Improve Customer Service in the Sewerage Division.

Secondary Goals

- Facilitate Information Access Throughout the Sewerage Division;
- Optimize Transport System Performance via Computerized Decision Support; and,
- Improve Facilities Planning Decision Making Throughout the Sewerage Division.

All of MWRA's major wastewater facilities have been integrated into the SCADA system. This includes twelve wastewater pumping facilities, five CSO storage/treatment facilities (including North Dorchester Bay CSO Storage and Pump Facilities), four remote headworks facilities, and one screen house. The existing Wastewater SCADA system is maintained by MWRA staff.

12.03 Wastewater Central Monitoring/SCADA Implementation Projects

The Wastewater Central Monitoring – Wastewater Redundant Communications Project is programmed in the FY14 CIP at a budget of \$700,000 during FY15-18. The estimated cost of this project has been reduced from previous CIP estimates. Communication changes implemented by MWRA staff will allow for redundancy at a significantly lower cost. This project is a candidate to be funded out of MWRA's CEB rather than the CIP.

There are two SCADA related projects recommended for consideration in future CIPs (see bullets below). The projects are described below and listed in the Project Summary Table 12-1 in Section 12.05. Other future Wastewater SCADA system enhancements will be based on recommendations derived from future modeling and system optimization studies. While there is no current plan to install a SCADA system at the Clinton Advanced Wastewater Treatment Plant, it may be desirable to include data collection and monitoring systems as part of future facility upgrades (see Chapter 14).

- Staff estimate that a Wastewater SCADA Equipment (PLC) Replacement/Upgrade project will be required every 20 years or when a significant enhancement in security architecture is released. Replacement/upgrade costs will depend on the level of reconfiguration and reprogramming required. For planning purposes, an equipment upgrade cost of \$5 million during the FY24-33 time frame (target of FY24) and a cost of \$5 million during the FY34-53 timeframe (target of FY44) are recommended for consideration in future CIPs. Each project would have a 5-year duration.
- Staff estimate that a Wastewater Microwave Radio Replacement project will be required every 20 years at a cost of \$240,000 during the FY19-23 time frame (target schedule of FY22) and a cost of \$240,000 during the FY34-53 timeframe (target schedule of FY42). These projects are recommended for consideration in future CIPs with a 2-year duration.

12.04 Wastewater Metering System

MWRA's wastewater metering system provides community flow-based rate assessments and data for modeling, engineering studies, infiltration/inflow estimates, and operational support. Installation of MWRA's initial wastewater metering system began in 1989 and was completed in 1994. This first system was comprised of ADS Environmental 3500 wastewater flow meters and facility remote terminal units (RTUs). By 2000, this system required extensive maintenance to function correctly and was near the end of its useful life. In November 2003, MWRA issued a Notice to Proceed for a contract (Contract No. 6793) to replace the wastewater metering equipment, which was completed in 2005.

As of June 2012, MWRA's wastewater metering system is comprised of the following:

- 134 Marsh McBirney Flo-Dar - Radar Based/Area Velocity Flow Meters;
- 53 MGD ADFM – Acoustic Doppler Flow Meters;
- 26 Facility RTU – Remote Terminal Units;
- 5 Marsh McBirney FloTote 3 – Electromagnetic Flow Meters; and,
- 3 Flume RTUs with depth sensors.

The Marsh McBirney Flo-Dar meters utilize ultrasonic depth and radar velocity as the primary means of measuring flow. The MGD ADFM meters utilize submerged ultrasonic depth and velocity as the primary means of measuring flow. The Facility RTUs capture, store, and transmit the signal/data from the respective facility's primary wastewater flow meter. The Marsh McBirney FloTote 3 meters utilize submerged pressure depth and electromagnetic velocity as the primary means of measuring flow. The Flume RTUs utilizes ultrasonic depth as the primary means of measuring flow in a flume. MWRA staff have been trained on software and field maintenance/bench technician procedures for the new metering system.



The above photo shows a typical wastewater meter installed in a sewer manhole. The data recorder is suspended at top of manhole and the depth/velocity sensor is mounted near the wastewater flow at the bottom of the manhole.



The above photo is a close-up of the depth/velocity sensor mounted near the wastewater flow.

The first phase of the Wastewater Metering System Equipment Replacement Project is complete. For the second phase, a total of \$1.3 million is budgeted in the FY14 CIP during the FY14-18 timeframe as described in the bullets below and listed in the Project Summary Table 12-1 in Section 12.05.

- The Wastewater Metering System Equipment Replacement Project - planning/study phase includes development of a long-term project to upgrade or replace the existing wastewater metering system (technology, hardware, software, telemetry). The permanent site improvements design phase include supply of power and enhanced wireless communications to approximately half of the permanent wastewater metering sites. The data from these sites will be used to optimize MWRA operation and maintenance activities during normal and wet weather conditions. The total cost programmed in the FY14 CIP for these phases of the project is \$300,000 during FY14-17.
- The Wastewater Metering System Equipment Replacement Project - permanent site improvements construction phase includes supply of power and enhanced wireless communications to approximately half of the permanent wastewater metering sites. The total cost programmed in the FY14 CIP for construction is \$1.0 million during FY17-18.

The Wastewater Metering System Equipment Replacement asset protection/equipment purchase phase includes rehabilitation, replacement and upgrades (planning, design and construction) for the wastewater metering system. This project represents the next phase of metering system equipment replacement which is estimated to be required about every 10 years. The total project cost programmed in the FY14 CIP is \$20.0 million and will be completed over the thirteen-year period FY16-28 in conjunction with the study, design, and construction projects for permanent meter site improvements noted above.

There is also one Wastewater Metering System related project recommended for consideration in future CIPs. This project is Wastewater Metering System Asset Protection - planning, design, and construction includes the rehabilitation, replacement and upgrades for the Wastewater Metering System estimated at \$5.0 million and projected to be required every 10 years for a total of \$10 million for two project phases over the long-term planning period from FY34-53. For planning purposes, funds for metering equipment asset protection have been estimated to be needed beginning in FY34 and FY44. Each of these projects will have a 3-year duration and is listed in the Project Summary Table 12-1 in Section 12.05.

12.05 Summary of Existing and Recommended Capital Projects

Projects in the FY14 CIP: There are four SCADA and Wastewater Metering System related projects programmed in the FY14 CIP. These projects are described below and summarized in Table 12.1 (see line numbers 12.01 through 12.04):

- Wastewater Central Monitoring – Wastewater Redundant Communications at \$700,000 during FY15-18.
- Wastewater Metering System Equipment Replacement planning/study and design at \$300,000 during FY14-17.
- Wastewater Metering System Equipment Replacement construction at \$1.0 million during FY17-18.
- Wastewater Metering System Equipment Replacement asset protection/equipment purchase project at \$20.0 million during FY16-28.

Projects Recommended for Consideration in Future CIPs: There are three SCADA and Wastewater Metering System related projects recommended for consideration in future CIPs. These projects are described below and summarized in Table 12.1 (see line numbers 12.05 through 12.07):

- Wastewater SCADA Equipment (PLC) Replacement/Upgrade project recommended at \$5.0 million during FY24-33 and \$5.0 million during FY34-53 for a total cost of \$10.0 million during FY24-53.
- Wastewater Microwave Radio Replacement project recommended at \$240,000 during FY19-23 (target schedule of FY22) and \$240,000 during FY34-53 (target schedule of FY42) for a total cost of \$480,000 during FY19-53.
- Wastewater Metering System Asset Protection planning/design/construction recommended at \$5.0 million every 10 years (target schedule of FY34 and FY44) for a total of \$10.0 million over the long-term planning period (FY34-53).

**Table 12-1
Wastewater Master Plan - SCADA and Wastewater Metering System
Existing and Recommended Projects**

Line No	Priority	Project	Project Type	FY14 CIP Project No.	FY14 CIP Contract No.	Project Duration	Cost (\$1000)	Schedule	FY14 CIP Notes				Total Cost (\$1000)	
									5 years	10 years	20 years			
SCADA & WASTEWATER METERING														
12.01	1	Wastewater Central Monitoring - Wastewater Redundant Communications	AP/Opti	137	10490_7363	4 years	700	FY15-18	700					700
12.02	2	Wastewater Metering System Equipment Replacement - Planning/Study and Design	Plan/RF	142	10371_6739 10410_6928	4 years	300	FY14-17	300					300
12.03	2	Wastewater Metering System Equipment Replacement - Construction	RF	142	10411_6929	2 years	1,000	FY17-18	1,000					1,000
12.04	2	Wastewater Metering System Equipment Replacement - Asset Protection/Equipment Purchase	AP/RF	142	10451_7191	13 years	20,000	FY16-28	4,231	7,692	8,077			20,000
SUBTOTAL - Existing - SCADA and Metering							22,000		6,231	7,692	8,077	0		22,000
12.05	3	Wastewater SCADA Equipment (PLC) Replacement/Upgrade, every 20 years	AP	new		5 years	10,000	FY24, FY44			5,000			10,000
12.06	3	Wastewater Microwave Radio Replacement, every 20 years	AP	new		2 years	480	FY22, FY42		240				480
12.07	2	Wastewater Metering System Asset Protection Plan/Design/Construct every 10 years	AP	new		3 years	10,000	FY34, FY44				10,000		10,000
SUBTOTAL - Recommended - SCADA and Metering							20,480		0	240	5,000	15,240		20,480
SUBTOTAL - Existing and Recommended - SCADA and Metering							42,480		6,231	7,932	13,077	15,240		42,480

CHAPTER 13 ENERGY MANAGEMENT, INFORMATION MANAGEMENT, LABORATORY SERVICES, AND SECURITY

13.01 Chapter Summary

The operation and maintenance of MWRA’s water supply and wastewater systems are supported by an array of processes, systems, and equipment. In this chapter, four specific support areas are detailed: (1) energy management, (2) information management, (3) laboratory services, and (4) security. Current conditions and needs of each are discussed below along with corresponding recommendations. Since all four of these support functions apply to both the water and wastewater systems, the discussion and recommendations have been included in both the 2013 Water System Master Plan (see Chapters 9 and 10) and 2013 Wastewater System Master Plan.

13.02 Energy Management

The Energy Management Section presented here is also presented as Chapter 10 of the 2013 Water System Master Plan. All energy management costs programmed in the FY14 CIP and recommended for consideration in future CIPs are included only in the Water System Master Plan and not in the Wastewater System Master Plan so that there would be no double counting of overall costs.

MWRA’s costs for electricity, diesel fuel and natural gas are a significant portion of direct expenses. MWRA’s total energy demand (for both water and wastewater systems) of 210,800,000 kWh and 493,250 therms (electricity and natural gas only) is equivalent to about 18,500 homes. Energy costs ranged from \$15 million (8.4% of total direct expenses) in FY02 to \$20 million (9.9% of budget) in FY11 (due in part to the addition of major new facilities including the Carroll Water Treatment Plant and to the varying price of energy). Spending temporarily escalated to \$26 million (13.8% of directs) in FY06 due to the spike in energy costs subsequent to Hurricane Katrina. This event highlighted the volatility of energy prices and reinforced MWRA’s efforts to aggressively manage energy usage and costs as an important part of MWRA’s overall rates management strategy.

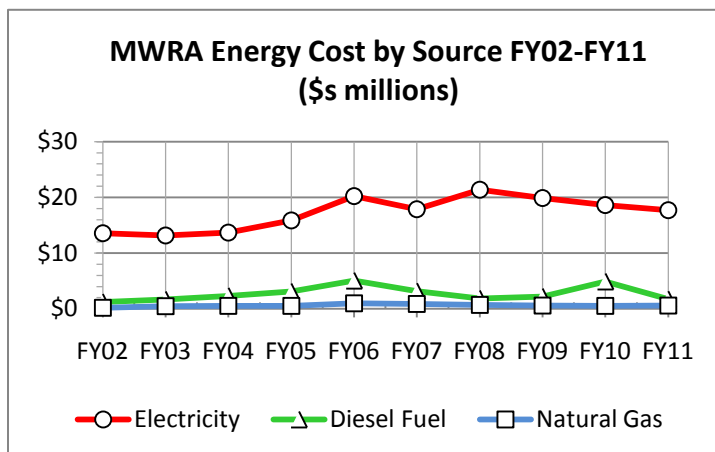

Notes:

- Significant increases in diesel fuel and electricity prices in FY06 to FY07 due to Hurricane Katrina.
- Significant increases in electricity prices again in FY08-FY10 due to market. Offset by declining purchases due to self-generation and energy-efficiency projects.
- Diesel fuel purchases increased in FY10 due to extensive CTG use during spring storms.

MWRA's energy initiatives have focused on all energy utilities but the major emphasis has been on reducing costs for electricity since it accounts for over 80% of the energy spending.

Strategies are generally broken into demand-side strategies and supply-side strategies. Demand-side strategies focus on opportunities to implement additional energy conservation measures as well as to maximize the use of existing and potential new base-load self-generation assets to reduce or offset MWRA's need for purchased energy. Supply-side strategies include efforts to focus on reducing energy costs through the optimization of competitive energy supply contracts while maintaining a balance energy portfolio. Other supply-side initiatives include continued evaluation of the operational and economic feasibility of enrolling back-up generation assets in load reduction programs and evaluating opportunities to shave peak demand thereby reducing electricity demand charges.

In 2007 Governor Patrick issued *Executive Order 484-Leading By Example-Clean Energy and Efficient Buildings* which directed, among other things, that state agencies make strides in energy conservation, reduction of greenhouse gases, and development and use of power from renewable sources. Progress was to be tracked and specific targets were set. In this same time frame, additional opportunities for state and federal energy related grants became available including the 2009 American Recovery and Reinvestment Act which prioritized a portion of funding for renewable energy projects. Utility rebates for energy efficiency have also continued to be an important component in an overall energy management strategy. Extensive progress has been made since FY02 and the following bullets reflect the breadth of MWRA's work.

- The total CEB impact of MWRA's energy savings and revenue initiatives has been approximately \$170 million during the FY02 to FY11 period with annual savings and revenue of \$24 million in FY11.
- Annual energy savings and revenues have increased from about \$6 million to almost \$24 million over the past decade (which reflects the addition of new energy generating equipment and facilities, additional revenues, and reduced energy use).
- Almost half of MWRA's total energy cost profile is derived from renewable sources (demand response, steam turbine generator (STG)/methane, wind, hydro, solar, renewable energy credits).
- MWRA has completed energy audits at its 36 major facilities. Implementation of audit recommendations and other process optimization efforts is estimated to save almost \$2 million annually.
- As a result of aggressively pursuing opportunities for grants and rebates, MWRA was awarded over \$12 million for funding of renewable energy and energy efficiency related projects (wind, solar, hydro).
- From 2005 to 2011, MWRA has received eight regional and national awards (most recently a 2011 Massachusetts State Leading by Example Award) for energy program leadership and project completion.

The sections below discuss MWRA's work to implement (1) renewable energy projects, (2) demand-side management programs, (3) supply-side management programs, (4) green power programs, and (5) recommendations for future work.

Renewable Energy

Consistent with Executive Order 484 issued by Governor Patrick in 2007, MWRA has made a priority of siting new renewable energy projects at as many facilities as economically feasible and continues to aggressively seek out any available grant and loan funds to improve project paybacks. Each renewable project is reviewed on a case by case basis to evaluate the reasonableness of payback periods (including the impact of grants and rebates). As shown below, almost half of MWRA’s total energy cost profile is derived from renewable sources.

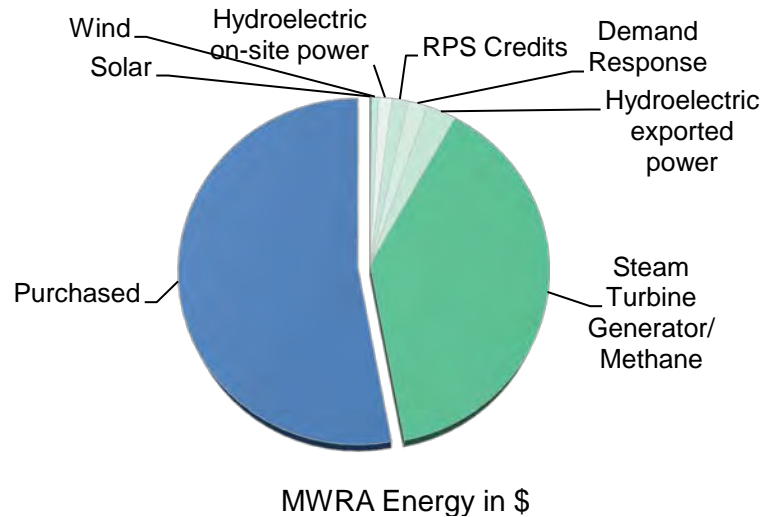

MWRA’s renewable energy generation of 58,320,000 kWh (not including the thermal value of digester gas) is equivalent to about 5,000 homes. This is similar to MWRA service area towns the size of Wilmington, Ashland, Bedford, and Swampscott.

Wind – MWRA has four operating wind turbines: two 600kW at DITP, one 100kW prototype FloDesign Wind turbine at DITP, and one 1.5 MW at Charlestown Pump Station. These four turbines will generate over 5 million kWh per year and provide a projected annual savings in electrical costs and revenue of about \$580,000. Future wind project considerations at Deer Island include MWRA turbines to be sited near Secondary Battery D, as well as a wind turbine to be developed by the City of Boston on the site of the former Deer Island Construction Support Building.



1.5 MW Turbine in Charlestown

Solar – Solar photovoltaic systems are currently installed at Deer Island on the roofs of the Residuals/Odor Control, Maintenance/Warehouse, and Grit Buildings and on the ground in the south parking lot. A system is also located on the grounds at the Carroll Water Treatment Plant. The solar photovoltaic systems represent over 1.2 MW of capacity and will produce over 1.4 million kWh per year of electricity and provide projected annual electrical cost savings and revenue of approximately \$240,000.



Hydroelectric - MWRA has a long history of using hydroelectric energy and continues to look for opportunities to capture the energy of water as it moves from higher to lower elevations. Hydroelectric facilities are currently located at Deer Island, Loring Road, Oakdale, and Cosgrove. These facilities represent over 8 MW of capacity and will produce about 23 million kWh of electricity per year with projected annual savings and revenues of over \$1,800,000.



The graph below indicates the increasing production of solar power (beginning in FY08) and wind power (beginning in FY10) at MWRA. Power production will continue to increase as new solar and wind facilities are added (such as the Charlestown turbine and Carroll solar which started in FY12). The hydropower generation fluctuates year to year based on water transfer needs and was particularly low in FY05 and 06 during start-up of the CWTP (as the Cosgrove generator was offline) and due to major maintenance of the Deer Island hydro turbine.

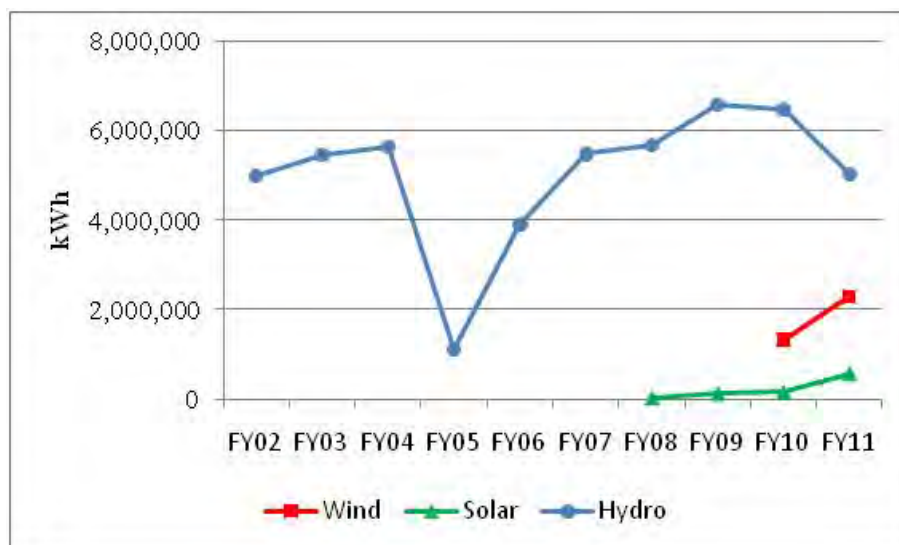

Methane - The capture of methane from the digesters was included in the original design contract of the Deer Island Treatment Plant. Co-generation at the Deer Island Thermal Power Plant (capacity of over 6 MW) using methane saves MWRA approximately 5 million gallons per year in annual fuel oil purchases (to heat the digesters and Deer Island buildings). The Power Plant Steam Turbine Generator at Deer Island allows MWRA to use steam from the methane powered boilers to produce electricity (valued at about \$2.3 million in FY11). Ongoing optimization upgrades at the thermal power plant/steam turbine generator are expected to result in a total additional annual electrical savings and revenue of about \$700,000. In addition, methane is a potent green house gas; therefore, its capture and use significantly reduces MWRA's carbon footprint.

Massachusetts Renewable Energy Portfolio Standard (RPS) – Retail electricity suppliers are required by Massachusetts regulation to provide a portion of their power from renewable energy sources. Renewable energy generators (like MWRA) can sell credits to electricity suppliers to help them meet the regulatory requirements. Since December 2002, MWRA has been selling its renewable energy credits through a competitive bid process. MWRA RPS eligible facilities have increased in recent years due to both new facilities being brought on line, as well as the Green Communities Act regulations that made hydropower eligible in 2009. MWRA has received about \$8 million in RPS revenue to date.

Regional Greenhouse Gas Initiative (RGGI) - Ten Northeast and Mid-Atlantic States participating in the Regional Greenhouse Gas Initiative have designed and initiated the first market-based, mandatory cap and trade program in the United States to reduce greenhouse gas emissions. The states sell emission allowances through auctions and invest proceeds in

consumer benefits: energy efficiency, renewable energy, and other clean energy technologies. The Deer Island combustion turbine generators (CTGs) are subject to the Massachusetts CO₂ Budget Trading Program, which implements the RGGI program in Massachusetts. MWRA must hold CO₂ allowances equal to CTG CO₂ emissions as of the end of each three year control period, the first of which ended December 31, 2011. As of March 2013, MWRA has purchased 54,000 CO₂ allowances (tons) at a cost of \$123,230.

Demand-Side Management

MWRA demand side management efforts include:

- Improving equipment energy efficiencies at operating facilities (lighting, variable frequency drives, HVAC system updates, treatment process modifications, etc.);
- Establishing operating protocols to reduce monthly and annual peak energy demand charges; and,
- Enrolling in demand response programs offered by regional grid operators.

Facility Energy Audits - Water and wastewater utilities are large energy users. The Governor's EO 484, MassDEP, and EPA efforts have focused on demand-side management in wastewater and water facilities. MWRA has put significant effort into energy conservation through implementation of energy audits at 28 of its 36 major facilities, process optimization, and installation of energy efficient lighting and equipment. These efforts saved about 8 million kWh and \$1,700,000 in FY 11. Energy audits on the remaining 8 major facilities were conducted during FY12 and recommended projects are being evaluated and implemented. Some of the projects include: an energy management system at the Chelsea and Southborough Facilities to automatically control HVAC equipment optimizing energy use, ventilation setbacks at headworks facilities, installation of VFDs on chemical scrubber pumps at the headworks, energy efficient lighting upgrades at the headworks, continued lighting improvements at DITP, etc. Engineering design reviews are undertaken by staff on all in-house projects for facility energy optimization (such as the proper selection of pumps, motors, lighting, etc.) to ensure that they are premium efficiency and eligible for utility rebates.

Demand Response Programs - The Carroll Water Treatment Plant and Deer Island Wastewater Treatment Plant participate in a demand response program run by ISO-New England that pays these facilities a monthly "capacity fee" for being available to go on back-up generation during periods of extremely high New England grid electricity demands. Deer Island began participating in 2001 and Carroll in 2008. The total revenue received under this program through FY11 was \$6.8 million. As of April 1, 2012, Chelsea Creek, Columbus Park, and Ward Street Headworks were also enrolled in the demand response program with annual expected revenue of \$26,000. Additional facilities continue to be evaluated for enrollment in this program.

Deer Island and Carroll have also avoided "peak capacity" charges by going off the grid during the ISO-NE peak operating hour. Monthly facility demand charges for the calendar year are set based on this peak hourly load. The total annual FY10 and FY11 savings from avoiding this charge ranges from about \$800,000 to \$1,000,000. Staff also modify facility operating practices to reduce energy use and/or costs such as tariff sensitive (off peak) timing of pumping operations and testing.

Supply-Side Management

Due to its large power purchasing, MWRA was an early entrant to the competitive electricity marketplace in 2001. The process has evolved into the creation of three distinct electricity supply contracts:

- Deer Island Wastewater Treatment Plant;
- Larger operations facilities including the Carroll Water Treatment Plant, Nut Island Headworks, Clinton Treatment Plant, and 22 other facilities; and,
- Smaller accounts including some of the pump stations and CSO facilities.

MWRA maintains a balanced electricity portfolio by contracting for a base block of power at a fixed-price and purchasing the balance of the load on the open market at real-time clearing prices. Currently over 60% of MWRA power is purchased on the fixed market. Estimated savings over the last 10 years from MWRA purchasing power competitively versus buying directly from the utilities are about \$30 million. MWRA's largest electric accounts are shown in Table 13-1 below.

TABLE 13-1 Largest MWRA Electric Accounts		
Facility	Annual Purchased Electricity (kWh)	Percent Share
Deer Island Treatment Plant	116,486,400	68.5%
Carroll Water Treatment Plant	10,387,608	6.1%
Nut Island Headworks	6,606,600	3.9%
Chelsea Maintenance Facility	2,672,200	1.6%
Newton St. Water Pump Station	1,239,600	0.7%
Braintree/Weymouth Intermediate Wastewater Pump Station	1,769,600	1.0%
Spring St. Water Pump Station	2,109,600	1.2%
Clinton Treatment Plant	2,133,697	1.3%
<i>Subtotal</i>	<i>163,659,000</i>	<i>84.3%</i>
Other Facilities	26,755,257	15.7%
Total	170,160,562	100.0%

Green Power and Other Sustainability Initiatives

In addition to all the efforts discussed above in support of MWRA and Commonwealth shared goals to increase renewable energy purchases and reduce greenhouse gas emissions at state facilities, MWRA has undertaken additional efforts to directly use more green power by maximizing the use of alternative fuel vehicles (biodiesel, CNG, hybrid, propane, and flex-fuel) representing about 70% of the fleet, and procuring green power ("National Green-e power") as a

portion of our total electrical purchases. The figure below shows how the percentage of our total electrical power use that is produced or purchased from green sources has increased over time.

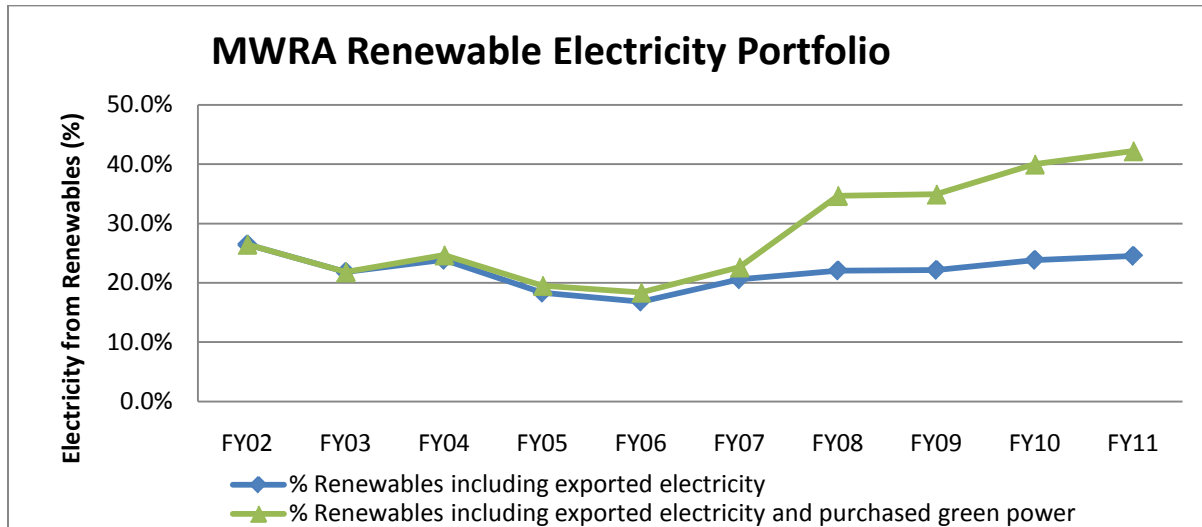

Summary of Existing and Recommended Energy Projects

All Master Plan projects related to energy management are summarized below.

- Hydropower** - Programmed in the FY14 CIP are two hydropower projects. The fish hatchery pipeline hydropower project at Quabbin Reservoir is scheduled for FY15-16 at a cost of \$670,000. The pipeline will convey cold, fresh water from the CVA to the downstream hatchery. The hydropower facility would be part of this project with power for use at the Ware Disinfection facility and sold to the grid. The second project, Wachusett hydropower, is programmed in the FY14 CIP for FY16-17 at a cost of \$1.446 million. However, permitting and the need to carefully assess any changes in releases to the Nashua River may impact the potential to develop this project. Staff will continue to explore alternative locations in the water transmission system which may provide hydropower development potential.
- Wind** - There are currently two future wind development projects in the CIP. The Deer Island Wind-Phase 2 project is expected to be developed by the City of Boston under an 8M permit issued by MWRA. This site has received FAA approval and is where the former Construction Support Building had been located. The second project, Future Deer Island Wind Construction would be located at the Secondary Battery D site where an MET tower is currently collecting wind data. Two turbines could be located at this site. FAA approval has not been sought for this location. The project is currently scheduled for FY16-21 at an approximate cost of \$4,615 million.

- Solar - Staff are working with a solar energy consultant to conduct a comprehensive solar feasibility study for all MWRA sites to assess the solar capability and technical and economical feasibility. Detailed feasibility studies have recently been completed for the 14 top-ranked sites from the desktop survey assessment. These studies provide MWRA with better quantification of its solar assets and valuable information to help identify a procurement process to lead to additional renewable energy infrastructure installations. Any installations resulting from this project would likely be developed as third party power purchase agreements and would therefore not require CIP funding.
- Demand-Side Management - Staff will continue demand-side energy management initiatives including: improving equipment energy efficiencies at operating facilities, establishing operating protocols to reduce energy demand charges, enrolling facilities in demand response programs, etc.
- Supply-Side Management - Staff will continue supply-side energy management initiatives including maintains a balanced electricity portfolio using both fixed price contracts and open market prices to minimize energy costs.

13.03 Information Management

The Information Management Section presented here is also presented in Chapter 9 of the Water System Master Plan. All information management services costs programmed in the FY14 CIP and recommended for consideration in future CIPs are included only in the MIS Five Year Strategic Plan (MIS Plan) and not in the Water System or Wastewater System Master Plans.

In the 2006 Water and Wastewater System Master Plans, the focus relative to information management was on those areas particularly germane to the operation of a large regional utility. MWRA owns and operates many dozens of facilities, miles of tunnels, interceptors and pipelines, dams, treatment facilities and thousands of ancillary structures (manholes, valves, meters etc.). This results in an extensive number and range of documents and records to be maintained and continually updated. Tools for organizing and accessing this information are critical to allow information to be accessed both quickly in emergency situations and in an organized manner to facilitate long-term rehabilitation and replacement of MWRA assets and to design new system components. Information must also be available to document permit or regulatory compliance, protect MWRA assets from damage by outside contractors or utilities, and for responding to litigation, if necessary. Given decreased staffing levels, it is important that procedures and tools for information management be developed and used to facilitate access to the most accurate information in the most efficient manner. This includes the need to ensure that “baseline” information systems at MWRA are brought up to date and include all of the agency’s current information and, equally important, that subsequent updates can be systematically added both to the baseline and to all of the other MWRA databases that rely on that baseline information.

In March 2012, MWRA completed a MIS Five Year Strategic Plan (“MIS Plan”). This MIS Plan was a result of conducting a baseline analysis of IT best practices compared with actual MWRA IT operating conditions, identifying the future needs of the business and developing a target state for technologies, and developing a set of programs and plans to meet those needs. Program initiatives were identified within four areas: 1) Technology Infrastructure Program; 2) Application Improvement Program; 3) Information Security Program; and, 4) IT Management Program. From these four categories, 15 actionable programs were identified. For this water and wastewater master planning effort, the analysis of the current issues and recommendation are made within the context of the new MIS strategic planning efforts. As the plan notes on page 16 of 122: *“Data architecture defines a framework for the structure of an organization’s logical and physical data assets and data management resources. The key objective is the ability to extract maximum business value from any data captured by the Authority, regardless of the data resource management system that contains it.”*

The actionable programs, from the four areas identified in the MIS Plan, of greatest relevance to Water and Wastewater System Master Planning are those identified under Application Improvement Programs. But it should be noted that the Application Improvement Programs cannot and will not succeed if the programs within the other three program areas are not successfully completed. For the details associated with the interdependencies of each of the programs, see Appendix B of the MIS 5 Year Strategic Plan.

The initial recommendation from the MIS Plan is that the Authority implement an Enterprise Content Management (ECM) program which would “address the organization’s dependence upon paper records, support records management activities, improve access to information, streamline work flows, and replace several existing departmental-level solutions.” According to the MIS Plan, ECM is an umbrella term which among other things includes document management, records management and work-flow management activities. These endeavors are particularly relevant to the issues discussed in the 2006 Master Plans including Record Drawing Management, Mapping and Modeling Issues and Work Order Management using Maximo.

As previously noted, the project costs associated with implementation of the recommendations of the MIS Plan are not included in either the Water System or Wastewater System Master Plans. Appendices C and D of the MIS Plan address costs and schedule. The FY14 CIP also incorporates many of the plan recommendations.

Record Drawing Management

Record drawings are the major category of information maintained by MWRA and these also provide the basis for MWRA’s GIS-based mapping and modeling systems. Authority record drawings exist on hardcopy and film, and are located in the Records Center, as well as at a number of MWRA and DCR facilities. A survey of these locations estimates the total number of drawings referencing MWRA infrastructure at 75,000. A subset of 60,000 of those drawings has been electronically scanned to the network. Record drawings at these locations vary from complete sets on recent contracts, to incomplete sets on pre-MWRA contracts, and partial sets for others. Design Information Systems Center (DISC) staff from the Engineering Department are involved in a review of these drawings in order to secure the latest revision for MWRA use. Drawings secured by DISC are chronicled in a number of pre-MWRA logbooks, recent departmental databases, and/or the Authority-wide document control system.

Organized drawing collections include the Records Center drawing archive, Chelsea water and sewerage microfilm archive, Deer Island (the Technical Information Center–TIC), the Western Operations files, Metro Operations files, and the Wastewater Engineering Unit compilation of recent construction projects, along with other miscellaneous collections. When a request for record drawings is made by staff or by outside consultants or contractors, staff search these sources first. InfoStar, acquired through the Boston Harbor Project, is used as the indexing tool. InfoStar requires replacement since the product is obsolete and there is no vendor support. Newer technology would provide improved efficiency and management control. Extensive documentation of current practices and procedures for processing record drawings, shop drawings, specifications, field sketches, etc. must be completed to ensure that any new system will thoroughly meet Authority needs.

In addition to proper management of records previously developed, there remains concern about missing or inaccurate records and the continued maintenance of multiple databases. As ECM programs are put in place, it will be critical to simultaneously begin to determine what records are missing or inadequate and institute projects to obtain the best available information. As an example, a preliminary review of GIS information indicates that relative to the water system records, approximately 120 record drawings and approximately 250 detail records are missing, incomplete or require updating. In addition, as an ECM approach is developed, historical issues such as non-standardized nomenclatures or lower/upper case differences, different data formats (Access v. Excel as an example) and variability in data collected for projects should be addressed. Mechanisms to efficiently update information so that the updated information is simultaneously available to all users should also be addressed. A broad based group of Authority staff familiar with the Authority's business practices and with both the current uses of these sources of information should be convened by MIS staff to ensure that these issues are addressed. Consultant assistance may be required to assist in the development of missing information.

Current Projects-Records Management

- The Document Control System Software Replacement project (previously in the CIP at a \$2 million value), has been folded into the Enterprise Content Management CIP project for consistency with the MIS Strategic Plan. Work is expected to start in FY14.
- The Distribution Systems Facility Mapping Records Development project is currently in the CIP and work is projected to start in FY16. This project is designed to develop or update record drawings and detail records for critical areas within the water distribution system where accurate records do not currently exist. The budgeted cost is approximately \$763,000.

Mapping and Modeling

MWRA sewer and water infrastructure data is created from Record Drawings and Detail Records and stored in GIS. GIS is then used to update the hydraulic model. A change in the field brought about by a capital improvement or an in-house project causes a chain reaction of updates: record drawings and detail records need to be updated and finalized, then submitted to GIS so the GIS and hydraulic model can be updated. An up-to-date GIS and hydraulic model facilitate flow of accurate information during emergencies, future project planning, and even master planning efforts. Thus, many of the recommendations for ensuring updated mapping and modeling data are the same as for ensuring that accurate record drawing information is available.

Again, program initiatives under the MIS Plan's Application Improvement Program address GIS Applications and Integration. GIS use at the Authority has increased exponentially over the years for water and wastewater site and routing studies, environmental analyses, hazard mitigation analyses, real property applications and litigation, and many other scientific, environmental and engineering uses. It also has the potential to "spatially enable" other Authority applications including programs such as sewer inspections, PIMS, expanded Maximo functionality and others. The MIS Plan recommends that an agency-wide GIS strategic plan be developed which would identify organizational roles and responsibilities, project priorities and processes for updating the GIS and keeping the data current. Programmed in the FY14 CIP is \$350,000 for this project with work scheduled in FY14-18.

Although it is not solely related to mapping and modeling, the MIS Plan also identifies Mobile Integrations as another initiative. The relationship to MWRA's GIS system and to mapping and modeling efforts is that immediate data entry at the source will help to update system information in the most timely fashion so that subsequent use of that information is accurate. In addition, it can be noted when previously mapped information is determined in the field to be inaccurate. Even applications as simple as noting and GPS locating pipe breaks or leaks, would allow that information to be accessed more efficiently than thru handwritten notes and map points. The GIS strategic plan proposed above should consider possible standard applications and procedures for mobile integration. This relates to the suggestion under Record Management as well, that the broader user group should discuss and address the issue of multiple versions of some databases. Mobile integration programs should work in conjunction with an identified primary database. Programmed in the FY14 CIP is \$150,000 for this project with a schedule of FY14-17.

Work Order Management-Maximo

Maximo is currently used as a work order maintenance system and it is designed to provide the planning function for the Maintenance Group. The Work Coordination staff use MAXIMO for planning and scheduling work and reporting on labor utilizations hours and percentage of work orders completed. MWRA staff also use MAXIMO to manage asset repair costs and to evaluate that cost in the determination of further equipment repair or replacement. The data are also used for specialized analyses.

Use of Maximo is always being reviewed and refined. The MIS Plan recommends the completion of the migration to Maximo Version 7.5, acquisition of additional modules and richer integrations, reconfiguration, improvements to work flow and reporting and business process

improvements to exploit the added functionality. Currently, MWRA uses Version 5.2 which is not compatible with Windows 7. MIS has developed integrations that use Lawson materials data to cost work orders and enables purchase requisitions to be linked to specific work orders. MIS has also developed a “one-way” integration between underground assets and GIS spatial data. Users can click on the representation of an asset on a GIS map and view Maximo asset attributes and work order history. Additional specialized applications have been developed to store maintenance management data including Lube sampling database; Preventive Maintenance Monthly Report; Predictive Maintenance Monthly Report; Reliability Centered Maintenance; Resource Leveling. And, Tool Tracking. The upgrade to Version 7.5 will eliminate the need for some of these in-house developed applications. That will mean that users will have a more fully integrated solution, redundant entries will be eliminated and MIS support needs should also be reduced. The added functionality of the updated version will also allow for future integrations, particularly with GIS. Migration to the updated version has begun. Maximo upgrades are in the FY14 CIP at a cost of \$1.75 million with work scheduled for FY14-18.

Pretreatment Information Management System

Another application improvement program identified in the MIS Plan with relevance to wastewater operations is the proposed enhancement to the existing Pretreatment Management System (PIMS). This package is used by TRAC to monitor industrial pretreatment permits, inspections, sampling, and enforcement activities for MWRA’s 210 Significant Industrial Users and 1,400 permitted facilities. PIMS integrates with MWRA’s Laboratory Information Management System which provides the results of samples. According to the MIS Plan, this enhancement program will assess the current state of PIMS implementation with the intent of developing a plan to address both existing functional issues and also to comply with new regulatory requirements. This project is programmed in the FY14 CIP at \$400,000 and is scheduled during FY14-17.

Conclusions

The assessment work that was done in preparation of the MIS Plan identified and further examined issues raised in the 2006 Water and Wastewater System Master Plans. Providing an Enterprise Content Management (ECM) framework for data will be a critical first step. For GIS-related efforts, the need to convene a broad-based group within the Authority to address the issues identified by users; to ensure that data standards are developed; and, that the integration of GIS with other existing and future Authority applications is of critical importance. As these efforts move forward, it will also be critical to identify and address issues with missing and/or inaccurate data. Increased confidence in data accuracy and improved accessibility along with the increased functionality of various applications should result in increased efficiency and improved response time for both day to day and emergency scenarios.

13.04 Laboratory Services

The Laboratory Services Section presented here is also presented in Chapter 9 of the Water System Master Plan. All laboratory services costs programmed in the FY14 CIP and recommended for consideration in future CIPs are included only in the Water System Master Plan and not in the Wastewater System Master Plan so that there would be no double counting of overall costs.

MWRA's laboratory services are client based. Clients include Deer Island, ENQUAD, TRAC Drinking Water Programs (including MWRA communities) and the Department of Conservation and Recreation (DCR). To accommodate the range of program needs, the geographic range of the MWRA system, and the types of samples to be analyzed requires MWRA's Department of Laboratory Services to operate multiple laboratory facilities in Chelsea, Clinton, Quabbin, Southborough, and the Central Laboratory located on Deer Island.

Samples are generally taken by staff within various programs and submitted to the appropriate laboratory location for analyses in compliance with a range of regulatory requirements, though Laboratory Services collects regulatory samples at the Clinton and Deer Island Treatment Plants. For example, TRAC staff sample industrial discharges for permit compliance and Quality Assurance staff obtain samples from the Carroll Water Treatment Plant to ensure proper plant performance and compliance with federal and state drinking water regulations. To provide a sense of the magnitude of work, Laboratory Services analyzes more than 250,000 samples per year for MWRA programs and the 39 MWRA member water communities. The work for the communities allows MWRA to both ensure sampling consistency and to quickly recognize patterns of bacterial contamination that could potentially occur in the system. MWRA also analyzes all DCR's reservoir and tributary samples in accordance with the MOU between MWRA and DCR.

Given the magnitude of the work effort, Laboratory Services continues to be proactive in identifying current and emerging issues. Staff safety while handling and analyzing samples must be protected through training and use of well maintained laboratory equipment and facilities. Staff resources must be efficiently allocated to ongoing work while thinking ahead to potential regulatory changes that may occur, particularly the identification of emerging contaminants. The laboratory must work closely with other MWRA departments to try to anticipate which contaminants might actually become a problem in order to focus limited resources on the relevant contaminants. Key questions to be answered when considering which contaminants to gear up for include: (1) how probable is it that a particular contaminant will become a problem, (2) will the concern be short-lived or a long-term problem, and (3) how much training and equipment are involved? A second issue relative to staff resources is the need to staff laboratories seven days a week in order to accommodate various sampling needs and requirements. This is a particular issue at those laboratory sites with limited staff overall. Finally, data management tools must keep pace with both the laboratory work load and significant advances in technology. Projects identified for Laboratory Services address these challenges.

Facility needs generally include periodic reconfiguration of space for work efficiency or to adapt to new test and/or equipment requirements. This is of particular importance at the Central Laboratory where this issue is addressed jointly by Laboratory Services, Deer Island managers, Operations, and Finance. In addition, periodic replacement of analytical or safety equipment is necessary. Ventilation equipment is particularly critical in this regard. Fume hoods at the Central Laboratory are now recommended for replacement along with the rest of the HVAC system both to address worker safety and to preserve sensitive analytical equipment. The fume hoods in the metals preparation laboratory were replaced in FY12 because they had corroded due to acid used in metals tests. This is a recurring expense approximately every 15-20 years.

Data management was addressed in 2009-2010 through the replacement of the 17 year-old Laboratory Information Management System (LIMS). The benefits of a new LIMS are more automation, consolidation of data, and the ability to electronically report drinking water results to MassDEP. Any additional data management tools necessary to more fully utilize and interface with the updated LIMS system are identified and coordinated between MIS and laboratory staff.

Summary of Existing and Recommended Laboratory Services Projects

All Master Plan projects related to laboratory services are summarized below.

- Fume Hoods and HVAC Systems - In 2010, Laboratory Services and Deer Island Engineering staff concluded that the replacement of the Central Laboratory fume hoods and the Administration/Laboratory Building's HVAC system should be combined into the same design and construction contracts. DITP HVAC equipment replacement design, engineering services during construction, and construction to replace odor control and air handler equipment (including DITP laboratory fume hoods) is programmed in the FY14 CIP at a cost of \$20.6 million during FY14-20. This project is carried as a DITP project in Chapter 6 of the Wastewater System Master Plan. This project is likely to present severe logistical issues for the Central Laboratory if large portions of the laboratory need to be shut down for extended periods of time. This may include the need for laboratory trailers that to meet MassDEP laboratory certification requirements. These contingencies will be addressed during the design contract.
- Major Laboratory Instrumentation - For decades the trend in environmental laboratory testing has been to detect lower and lower concentrations of contaminants in small quantities of complex samples. Over the past 20 years, decisions have been made as new contaminants have emerged into prominence whether MWRA should perform this testing in-house or contract the work out. These decisions have been weighted by whether the contaminant is likely to be important in MWRA drinking water or wastewater, how many samples are likely to need to be tested, and how expensive or complex the laboratory instruments will be. For example, when MassDEP began regulating perchlorate in drinking water, MWRA decided to contract out the few required samples a year since perchlorate was unlikely to be detected in MWRA drinking water. As MassDEP and EPA continue to regulate more contaminants in drinking water and wastewater, it is likely that eventually MWRA will choose to purchase complex, and therefore expensive, laboratory instruments when the number or tests is likely to be large or the consequences of the testing critical to MWRA's mission. The CIP should continue to carry funding for major laboratory instrumentation, such as Dynamic Reaction Cell (DRC) ICP-MS (inductively coupled plasma mass spectrometry for metals and high resolution GC-MS (gas chromatography-mass spectrometry) or LC-MS (liquid chromatography-mass spectrometry) for organics. For these types of major laboratory instrumentation, \$1.0 million is programmed in the FY14 CIP and spending is projected in FY15-18.
- Laboratory Instrument Data Management - Now that the LIMS upgrade has been completed, there is a need for ancillary in-house data management improvements for laboratory instruments. MassDEP certification and Massachusetts records retention laws requires that raw data from instruments be retained and accessible for up to 15 years.

While the final results and a limited amount of raw data are transferred from the instruments' data systems to LIMS, the bulk of the raw data are retained and archive outside of LIMS. The current approach is labor-intensive, thus a more user-friendly, automated approach is needed. Laboratory Services has identified a need for this type of system and a \$550,000 LIMS Enhancement project began in FY13. Programmed in the FY14 CIP is the remaining \$545,000 with spending projected in FY14-18.

- Laboratory Facilities Renovations - Department of Laboratory Services staff, together with other MWRA Operations staff, should develop a system to efficiently and quickly reconfigure laboratory space to accommodate new sampling requirements or new equipment. This will allow the Laboratory to maintain high levels of efficiency with minimum disruptions to ongoing work. Laboratory Services staff should identify any technological changes or equipment that will assist in improving staff efficiency. The Central, Chelsea, and Southborough Laboratories are fairly new, while the Clinton and in particular Quabbin Laboratories are showing signs of age. A future project to facilitate renovations at all five laboratory facilities is recommended for consideration in future CIPs (planning, design, and construction) at an estimated total cost of \$20.0 million over the 40-year planning period FY14-53 (this represents an average annual investment in the five laboratories of \$500,000 per year).
- Wireless LIMS and instrument interfaces - Advances in wireless tablet and handheld devices will eventually become suitable for use in laboratories. Samples progress from the field to sample receiving, preparation, analysis, data processing, final reporting, and disposal. In the future, each staff in the laboratory is likely to have their own mobile device that is used for all tasks involving samples, instruments, and instrumentation which will increase productivity and reduce the need for paper records. A future project to purchase equipment and facilitate wireless laboratory transactions at all five laboratory facilities is recommended for consideration in future CIPs at an estimated total cost of \$500,000 projected during the FY14-23 timeframe.

13.05 Security

The Security Section presented here is also presented in Chapter 9 of the Water System Master Plan. All security costs programmed in the FY14 CIP and recommended for consideration in future CIPs are included only in the Water System Master Plan and not in the Wastewater System Master Plan so that there would be no double counting of overall costs.

MWRA's investment in security for water and wastewater pipelines and facilities, as well as, the Authority's information systems, has increased significantly over the past twelve years. Since 2001, MWRA has invested approximately \$7.5 million in security related upgrades specific to security equipment and installation projects. Additional funds have also been expended that were included within individual capital projects for new or rehabilitated facilities. A detailed description of MWRA security measures is not included in the Master Plan due to the sensitive nature of the topic. In general, MWRA has been evaluating and ranking facilities and locations with respect to the critical nature of service delivery for each site. As appropriate, effective security improvements are planned, scheduled, and constructed. In general, MWRA's security improvements include:

- Gate and signage upgrades to limit access in specific areas and to denote areas where the public is welcome;
- Access card readers at facilities to monitor entry;
- Locked/unlocked door alarms monitored continuously;
- Video camera monitoring of key locations;
- Central monitoring of data and alarms for all facilities;
- Automated water quality monitoring;
- Planning and coordination with state and local police;
- Planning and drills for incident response;

Current Projects-Security

- Additional expenditures under the Security Equipment and Installation project are included in the FY14 CIP at \$1.295 million during FY14-15. This project will continue to upgrade security measures for water and wastewater facilities.
- Information systems security is an integral part of the MIS Strategic Plan. A number of MIS security related projects are combined under the Information Systems Program and are budgeted in the FY14 CIP at \$792,000 and scheduled during FY14-17.

CHAPTER 14

CLINTON ADVANCED WASTEWATER TREATMENT PLANT

14.01 Chapter Summary

The Clinton Advanced Wastewater Treatment Plant (AWWTP) provides advanced sewage treatment services to the Town of Clinton and a portion of the Town of Lancaster - the Lancaster Sewer District. Since assuming formal operational responsibility for the plant in 1987¹, MWRA has designed and constructed new primary and secondary treatment facilities that incorporate rehabilitated portions of the previous plant with new construction. The upgraded treatment plant and sludge landfill was completed in 1992 at a cost of \$37 million. The plant provides secondary treatment using an activated sludge process in combination with advanced nutrient removal and dechlorination. The plant effluent is discharged into the South Branch of the Nashua River in accordance with the discharge limits of the facility's National Pollutant Discharge Elimination System (NPDES) permit. The replacement asset value of the Clinton AWWTP is \$50 million (1% of wastewater system asset value). See detail on Wastewater Infrastructure Replacement Asset Value in Section 3.07.

The Clinton AWWTP is 20 years old and in generally good condition. Some equipment rehabilitation and replacement projects are recommended; however, significant reinvestment is not required in the short-term. Operability of mechanical/pumping equipment (particularly during large storm events) and technology upgrades to meet regulatory requirements are key elements to minimize risk of component failure. Key decision making for risk avoidance includes the cost/benefit of when to replace aging equipment and which/how many spare parts to pre-purchase. Other Clinton AWWTP needs include future upgrades to the sludge landfill.

One of the most important themes of the Master Plan, consistent for all MWRA water and wastewater facilities, is prioritization of rehabilitation and replacement projects to facilitate long-term asset protection. A long-term annual asset protection budget of \$100,000 per year for the 10 year period FY14-23, and expanding to \$300,000 per year for FY24-53, is recommended for future consideration to fund smaller scale Clinton projects that, individually, may not be seen as high priority.

For the Clinton AWWTP, \$41.222 million in projects is identified in the 40-year master plan timeframe (FY14-53). Four projects (\$14.347 million) are programmed in the FY14 CIP. Ten additional projects (\$26.875 million) are recommended for consideration in future CIPs. Section 14.08 – Summary of Existing and Recommended Capital Projects includes a consolidated list of all projects recommended in this Chapter. Additional current and long-term regulatory issues and potential impacts on MWRA are detailed in Chapter 4.

¹ See Section 14.2 for detailed Clinton Wastewater Services History

Near-term (FY14-18):

- \$10.753 million is programmed in the FY14 CIP:
 - \$6.658 million to upgrade the phosphorous removal system;
 - \$3.111 million to clean and rehabilitate the sludge digesters and repair plant-wide concrete deterioration;
 - \$509,000 to rehabilitate the roofing on various buildings at Clinton AWWTP; and,
 - \$475,000 to begin the Clinton Facilities Rehabilitation project for grit removal facilities, two belt filter presses, and closure of landfill cell #1.
- \$775,000 in needs are recommended for consideration in future CIPs:
 - \$500,000 for long-term asset protection (first 5 years at \$100,000 per year);
 - \$175,000 to replace/rehabilitate four process water pumps; and,
 - \$100,000 to upgrade security at the Clinton AWWTP and the sludge landfill.

Mid-term (FY19-23):

- \$3.594 million is programmed in the FY14 CIP to complete the Clinton Facilities Rehabilitation project for grit removal facilities, two belt filter presses, and closure of landfill cell #1.
- \$7.1 million in needs are recommended for consideration in future CIPs:
 - \$500,000 for long-term asset protection (second 5 years at \$100,000 per year);
 - \$1.5 million to replace three influent and three intermediate lift pumps;
 - \$2.0 million for primary treatment upgrade and additional concrete repairs;
 - \$2.0 million to upgrade technology to meet future regulatory requirements;
 - \$1.0 million to add a fourth tank to the secondary clariflocculator; and,
 - \$100,000 to repair/seal the plant roadway.

Long-term (FY24-33 and FY34-53):

- \$19.0 million in needs are recommended for consideration in future CIPs:
 - \$9.0 million (\$3.0 million in FY24-33 and \$6.0 million in FY34-53) to continue long-term asset protection (at \$300,000 per year);
 - \$6.0 million (\$2.0 million in FY24-33 and \$4.0 million in FY34-53) to upgrade technology to meet future regulatory requirements;
 - \$3.0 million to add a UV disinfection system in FY24-33; and,
 - \$1.0 million to expand the landfill and add a fourth cell in FY24-33.

14.02 Clinton Wastewater Service History

At the time the Wachusett Reservoir was constructed in the late 1890s, land for the reservoir was taken from the Town of Clinton. Since the Town's sewers discharged directly into the Nashua River, the newly dammed reservoir reduced the flow of water which, in turn, inhibited the washing of raw sewage downstream. In consideration, the Commonwealth was authorized to make additional takings of land in Clinton and Lancaster for a sewage treatment plant to serve Clinton, and later Lancaster, and designated the Metropolitan Water Board (and subsequently the MDC) to be responsible for its initial operation and maintenance. The 1898 legislation authorizing the project provided that "the metropolitan water board shall transfer to said town [Clinton] all the works, lands, water rights . . . "when". . . the sewage of said town shall have

outgrown the normal capacity of the south branch of the Nashua River to properly dispose thereof.” The 1898 legislation expressly envisioned that ownership and responsibility for the treatment plant would be transferred back to Clinton.

Several attempts have been made to transfer ownership of the sewage treatment plant back to Clinton, but have proved unsuccessful:

- By 1923, the sewer flow had doubled and could no longer be handled by the plant. The MDC attempted to transfer ownership back to Clinton. Though no details are available, it is believed that the Town took MDC to court and prevailed.
- In 1969, MDC again sought to transfer ownership back to Clinton. It is believed that Clinton brought the issue to the attention of the Attorney General where it appears that legislation, adopted in 1954 and discussed below, would have been relied upon by Clinton in support of the MDC’s obligation to continue to maintain the facility.

Attempts to transfer responsibility back to Clinton became all the more difficult after 1954 when the Legislature directed MDC to construct, maintain and operate a modernized, replacement plant at its own expense. Thereafter, the provisions of chapter 509 of the Acts of 1980 again required that MDC improve the plant to comply with federal and state standards. While the act also required MDC to “take in consideration the sewerage treatment needs of the towns of Lancaster, Sterling, Bolton and Berlin”, the principal users of the facility remain Clinton and the Lancaster Sewer District. The provisions of this 1980 enactment also expressly provided that all users of the facility would pay their proportionate share of both debt service costs and operating, maintenance, and replacement costs “exclusive of the town of Clinton.”

Upon the creation of the MWRA in 1985, the Enabling Act generally transferred all of the functions of the MDC Sewerage and Water Divisions to MWRA without any specific mention of the Clinton Wastewater Treatment Plant. Despite an initial disagreement between MWRA and MDC over which agency had the responsibility for the facility, MWRA has operated the plant since its inception.

In November 1986, the MWRA Board of Directors voted to file legislation to have MWRA build a new plant in Clinton to be paid for entirely by funds from the state and federal governments. The legislation stipulated that MWRA would run the new plant, but the cost of doing so would be paid by the residents of the Town. As continued compensation for the land taken from the Town at the time the Wachusett Reservoir was built, part of the legislation provided for Clinton to receive an annual payment from the Commonwealth equal to the assessment it pays the MWRA. Subsequently, the provisions of chapter 307 of the Acts of 1987 determined that MWRA would be responsible for the operation of the Clinton AWWTP. That statute also provided that the MDC’s Division of Watershed Management would annually pay the Town of Clinton, subject to appropriation, an amount equal to the Town’s MWRA user charges, provided that this payment not exceed \$500,000. The \$500,000 amount was selected because it was believed to be Clinton’s share of the total cost of the operations and maintenance of the plant at the time the legislation was written. For many years, the value of services provided to Clinton by MWRA has exceeded the \$500,000 cap. As a result, the MWRA ratepayers have subsidized

the Town of Clinton's sewer charge by as much as \$1.5 million based on the FY14 budget and by more than \$20 million over the past 20 years.

MDC's payment obligation under the statute was expressly made subject to a legislative appropriation. From 1987 to 1994, the Legislature failed to appropriate the \$500,000 to MDC. During this period, Clinton claimed that the 1987 legislation meant it did not have to pay unless there was an appropriation to MDC. It therefore failed to pay MWRA's annual charges. In response, the MWRA filed a lawsuit against the Town of Clinton in 1991 for nonpayment of its user charges relative to the plant. Clinton defended itself against the suit by joining MDC as a party claiming that it had no obligation to pay absent an appropriation and further asserted that MDC should ultimately shoulder the payment if it was determined that Clinton was required to pay MWRA's charges. The court ruled against Clinton finding that the Town had to pay even without a legislative appropriation and that the MDC would not be liable to the Town for the annual payments. The court entered a judgment in MWRA's favor in the amount of \$6.1 million, inclusive of interest.

While the case was on appeal to the Supreme Judicial Court, the Legislature intervened in 1996. The 1996 legislation provided \$4 million to MWRA to satisfy Clinton's past due charges and appropriated additional sums needed to upgrade the plant. The legislation also mandated that the parties enter into a settlement agreement which was memorialized in a December 30, 1996 Memorandum of Agreement. That agreement does not contain any provision which determines the parties' rights and responsibilities in the event that the Legislature was to fail to make any future annual \$500,000 appropriation. In fact, the agreement mandated that the court judgment in MWRA's favor be vacated and that all parties would reserve all of their rights in the event that the appropriation was not made in the future. Since that time, the Legislature has appropriated the \$500,000 annually, although on October 15, 2009 as part of the 9C cuts funding was eliminated, but later restored.

14.03 Facilities Overview

The Clinton AWWTP provides advanced sewage treatment services to the Town of Clinton and a portion of the Town of Lancaster (the Lancaster Sewer District). The location of the Clinton AWWTP and sludge landfill are shown on Figure 14-1, and an aerial photograph of the plant is shown in Figure 14-2. MWRA completed construction (and rehabilitation of some older portions of the plant) in 1992. The plant uses an activated sludge process in combination with advanced nutrient removal and dechlorination. Major treatment components include headworks, primary settling tanks, digesters, sludge processor, trickling filters, aeration tanks, secondary tanks, and a chemical addition building. The plant effluent is discharged into the South Branch of the Nashua River in accordance with the discharge limits of the facility's NPDES permit.



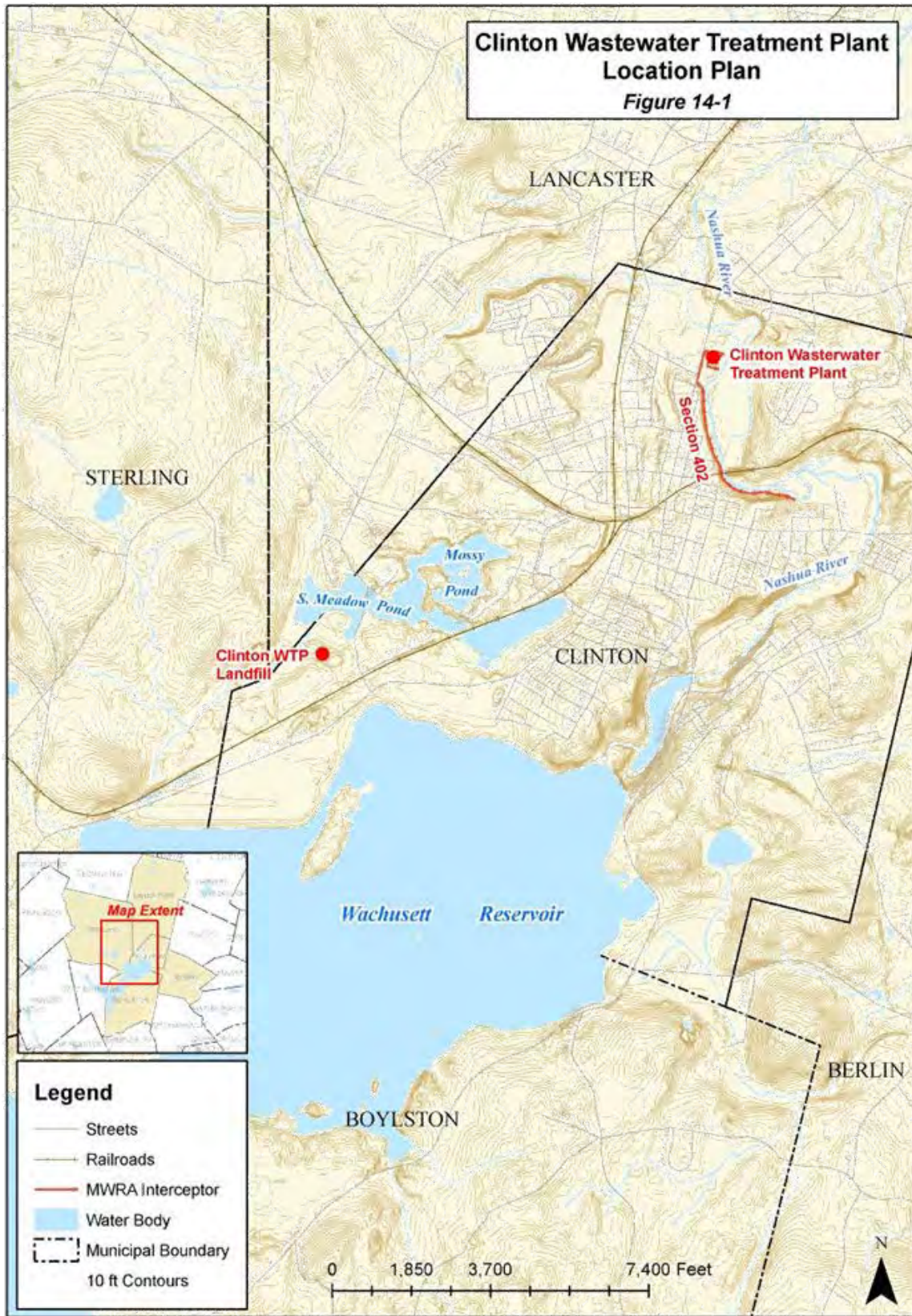

FIGURE 14-2
Aerial Photo of Clinton AWWTP



Residual materials are digested, dewatered (pressed), and transported to an MWRA-owned and operated landfill for disposal, which is monitored regularly by staff. MWRA's goal is to operate and maintain the treatment plant to provide uninterrupted wastewater treatment in a safe, cost-effective, and environmentally sound manner.

Management of the Clinton AWWTP is the responsibility of the Superintendent under the supervision of the Director of Wastewater Treatment. Wastewater Treatment is a subset of the Operations Division under the oversight of the Chief Operating Officer. Key staff reporting to the Clinton Superintendent include: Area Manager, Area Supervisor, and Maintenance and Operations Specialist. Seven staff positions are responsible for the operation and maintenance of the Clinton AWWTP. In addition, one Laboratory Services staff is assigned to the Clinton AWWTP.

Operation and Maintenance: A primary focus of MWRA staff is preventive maintenance. Daily coordination ensures that primary and critical equipment are functioning at adequate levels at all times. Work is prioritized, with critical equipment receiving the most attention. The in-house maintenance program is supplemented by a series of service contracts.

Cost Allocation: In accordance with MWRA's Clinton Sewer Service Area rate methodology adopted in 1991, the City of Worcester is charged approximately 7.9 percent of the direct operating expenses of the Clinton AWWTP. Worcester has been paying this annual charge to MWRA or its predecessors since 1914. The Town of Clinton and Lancaster Sewer District are allocated proportional shares of the remaining expenses based on annual metered wastewater flow. However, pursuant to Chapter 307, Section 8 of the Acts of 1987, Clinton is only liable for the first \$500,000 of its share of operation, maintenance, and capital costs.

14.04 MWRA and Local Collection Systems

MWRA owns and maintains approximately one mile of 20, 24, and 30-inch interceptor in Clinton that parallels the South Branch of the Nashua River between High and Williams Streets. The interceptor (MWRA Section 402) is constructed of vitrified clay and brick pipe and serves primarily residential areas. MWRA relined approximately 2500 linear feet of the interceptor in 1992 and the remaining 3000 linear feet in 2000. During the pipeline rehabilitation projects, all MWRA-owned manholes were coated with an epoxy lining. The relined interceptor and manholes are in very good condition. MWRA staff periodically inspect interceptors and manholes to monitor system condition. In 2010, MWRA interceptor Section 402 was added to the sewer GIS data-base and GIS maps were developed for the Clinton and Lancaster Sewer District tributary areas to the Clinton AWWTP.

Clinton Collection System: The Clinton wastewater collection system includes approximately 50 miles of sewers ranging in diameter from 8 to 30 inches. Some of the sewer system was built during the mid-1880s as the textile industry and population grew. There are nine public and eleven special connections to the MWRA-owned interceptor. Flows from various sections of Clinton are collected by two circular brick interceptors: (1) the 30-inch Counterpane Brook Interceptor that parallels Counterpane Brook and connects to the MWRA interceptor near High and Allen Streets, and (2) a 30-inch pipe that connects to the upstream end of the 20-inch MWRA interceptor. Most of the Clinton collection system is gravity flow; however, there are seven small pump/lift stations.

Lancaster Collection System: The southern portion of the Town of Lancaster (Lancaster Sewer District) is served by a wastewater collection system initially constructed in 1978. The system includes seven small pump stations and approximately 25 miles of pipeline, primarily 8, 10, and 15-inch diameter lateral sewers. The Town's one main interceptor (15 to 36-inch diameter) collects flow from the lateral sewers and connects to the Clinton AWWTP on High Street. This is the only public connection from the Lancaster Sewer District to the Clinton AWWTP.

14.05 Wastewater Flow and Quality to Clinton AWWTP

Wastewater Flow: Clinton AWWTP influent and effluent flow data are part of monthly NPDES reporting. The permit requires MWRA, the Town of Clinton, and the Lancaster Sewer District to eliminate excessive I/I to the sewer collection system which each owns and operates. MWRA submits a permit-required annual report to EPA and MassDEP which provides an analysis of infiltration and inflow (I/I) trends. Table 14-1 shows the Clinton AWWTP effluent average daily flow (ADF) for 2002 through 2011 and annual rainfall from Clinton and Worcester NOAA Rain Gauges.

**TABLE 14-1
Clinton AWWTP Effluent Flow and Rainfall Data**

Calendar Year	Effluent ADF (mgd)	Clinton Rainfall (inches)	Worcester Rainfall (inches)
CY02	2.27	45.59	44.07
CY03	2.90	44.43	50.52
CY04	2.82	49.24	45.84
CY05	3.34	43.68	59.58
CY06	3.45	52.89	51.29
CY07	2.92	39.27	43.34
CY08	3.32	66.77	63.21
CY09	3.37	53.86	50.08
CY10	3.04	53.09	51.38
CY11	3.41	61.40	67.15
10-year average	3.08	51.02	52.65

The Clinton NPDES Permit limit for effluent flow is 3.01 mgd (rolling annual average using the reporting month and monthly averages for the preceding 11 months). Since March 2005, the NPDES effluent flow limit has been exceeded periodically. For CY10 and CY11, the NPDES effluent flow limit was exceeded 15 of 24 months.

Higher sanitary flows and infiltration/inflow from the local collection systems cause increased flows. Clinton and Lancaster sanitary flows are about 1.60 mgd, groundwater infiltration ranges from 0.5 mgd (low groundwater) to 2.5 mgd (high groundwater in spring); and stormwater inflow (from a 1.7-inch MassDEP design storm) is approximately 1.0 mgd (data from annual wastewater flow reports CY07-11). I/I from the local collection systems significantly increases influent flow to the Clinton AWWTP. MassDEP Administrative Consent Orders require developers adding new sanitary flows in Clinton and the Lancaster Sewer District to offset those flows by removing twice that volume of I/I from the local sewer system. The Town of Clinton and Lancaster Sewer District are responsible for eliminating excessive I/I to their sewer collection systems; no MWRA Master Plan CIP projects are recommended for the locally-owned collection system.

The relined MWRA-owned interceptor is in very good condition. A December 2010 internal inspection showed minimal infiltration and no significant defects, and for the 40-year Master Plan period, no CIP projects are recommended for the MWRA-owned interceptor. Using CEB funds, MWRA should continue to periodically inspect and maintain the MWRA-owned interceptor and manholes.

Wastewater Quality: MWRA submits monthly discharge monitoring reports to EPA and MassDEP for Biological Oxygen Demand (5-day), Total Suspended Solids, Fecal Coliform, Total Residual Chlorine, Total Copper, Total Phosphorus, Total Ammonia Nitrogen, Dissolved Oxygen, and pH. For CY10 and CY11, all limits were met. Sampling frequencies and discharge monitoring limits are presented in Table 14-2. No significant changes in wastewater quality parameters are anticipated; future CIP projects to address wastewater quality will most likely be based on revised NPDES permit limits, as discussed in Section 14.06 and in Chapter 4.

TABLE 14-2
Clinton NPDES Sampling Frequencies and Discharge Monitoring Levels

Effluent Characteristic	Units	Monthly Average	Discharge Limit Weekly Average	Daily Maximum	Monitoring Requirement Measurement Frequency	Sample Type
Flow	mgd	3.01	---	Report	Continuous	Recorder
BOD ₅	mg/L	20	20	Report	3/Week	24-Hour Composite
	lbs/day	500				
TSS	mg/L	20	20	Report	3/Week	24-Hour Composite
	lbs/day	500				
Fecal Coliform	#/100 mL	200	---	400	3/Day	Grab
Total Residual Chlorine	ug/L	50	---	50	3/Day	Grab
Copper, Total	ug/L	20	---	---	1/Month	Grab
Total Phosphorus (5/1-10/31)	mg/L	1	---	Report	1/Week	24-Hour Composite
Total Ammonia Nitrogen (4/1-4/30)	mg/L	10	---	Report	1/Two Weeks	24-Hour Composite
Total Ammonia Nitrogen (5/1-5/31)	mg/L	5	---	Report	1/Week	24-Hour Composite
Total Ammonia Nitrogen (6/1-10/31)	mg/L	2	---	3	3/Week	24-Hour Composite
Total Ammonia Nitrogen (11/1-3/31)	mg/L	10	---	35.2	1/Month	24-Hour Composite
Dissolved Oxygen	mg/L	6 mg/L daily minimum			1/Day	Grab
pH	SU	6.5-8.3			1/Day	Grab

14.06 Clinton NPDES Permit

Wastewater treatment performance at the Clinton plant is excellent; the plant consistently meets its permit limits except for effluent flow which is limited to 3.01 mgd (rolling annual average using the reporting month and monthly averages for the preceding 11 months). The average annual daily flows in CY08, CY09, CY10, and CY11 were 3.32, 3.37, 3.04, and 3.41 mgd, respectively. High flows occur in wet weather, and are caused by I/I in the local collection systems. The Clinton NPDES permit attempts to address I/I from the Town of Clinton and the Lancaster Sewer District by including them as co-permittees in two sections addressing conditions regarding the operation and maintenance of the local collection systems.

The current NPDES permit for the Clinton AWWTP expired in 2005, but remains in force until EPA issues a new permit. In September 2010, EPA issued a draft NPDES permit for public comment, and in September 2013 EPA re-issued a revised draft permit for public comment. As of October 2013, MWRA provided written comments to EPA on key issues to preserve MWRA's rights to appeal portions of the permit. The 2013 draft permit contains significant changes compared to the prior permit that expired in 2005:

- More stringent limits, year-round, on phosphorus. These limits are consistent with those issued to other POTWs in the Nashua River watershed. MWRA in its comments requested a 4-year compliance schedule for planning, design, and construction of new phosphorus removal facilities.

- Requirement to report aluminum. Aluminum levels in Clinton AWWTP effluent were determined to have the potential to exceed the chronic water quality standard for aluminum (the effluent does not have the potential to exceed the acute limit). The source of the aluminum was the alum previously used for phosphorus removal through 2010. Alum use for phosphorus removal was discontinued during 2011 and replaced with ferric chloride. It is widely held that EPA's chronic aluminum criterion is unduly stringent and several states have passed less-stringent site-specific criteria, but it is not known if Massachusetts will do this.
- Copper is not expected to be an issue in the future as the Massachusetts Water Quality Standards for copper were modified in 2007 to create less-stringent site-specific copper criteria in the Nashua River watershed. The limits in the draft Clinton NPDES Permit are based on existing discharges.
- EPA is in the process of revising the freshwater water quality criteria for ammonia. The new criteria will likely be more stringent than existing criteria. Effluent limits for ammonia at Clinton AWWTP may drop from the present (a seasonal low of 2 mg/l) to approximately 1 mg/l or slightly lower. In addition, there is a potential for the more stringent limit to apply year-round rather than just in the summer months. The new ammonia criteria may affect the NPDES permit that follows the 2013 draft permit, or EPA could re-open the (now draft) Clinton NPDES permit to implement the new ammonia criteria when they are promulgated.
- Effluent limit on flow will likely continue to be problematic because the flow limit in the 2013 draft permit (annual average of 3.01 mgd) is the same as the effluent limit in the prior permit that expired in 2005.

Two MWRA projects are specifically intended to improve plant process technology to meet anticipated phosphorous removal requirements. The Clinton aeration efficiency improvements project was recently completed in FY13 at a cost of \$2.0 million. A phosphorus removal (design and construction) project is programmed in the FY14 CIP at \$6.658 million. Future regulatory requirements and potential changes to the Clinton NPDES Permit may impact MWRA's recommended capital projects (see additional detail in Chapter 4). A total of \$8.0 million is recommended for consideration in future CIPs for technology upgrades during the FY19-53 timeframe. All programmed and recommended CIP projects are detailed in Section 14.08.

14.07 Clinton AWWTP Process Operations

Major Clinton AWWTP processes include preliminary treatment, primary treatment, secondary treatment, advanced treatment for nutrient removal, effluent disinfection/dechlorination, and residuals processing/disposal. The plant effluent is discharged into the South Nashua River in accordance with the discharge limits of the facility's NPDES permit. Residual materials are digested, dewatered (pressed), and transported to an MWRA-owned dedicated landfill for disposal. The Clinton AWWTP process flow schematic is presented as Figure 14-3.

FIGURE 14-3 Clinton AWWTP Flow Schematic

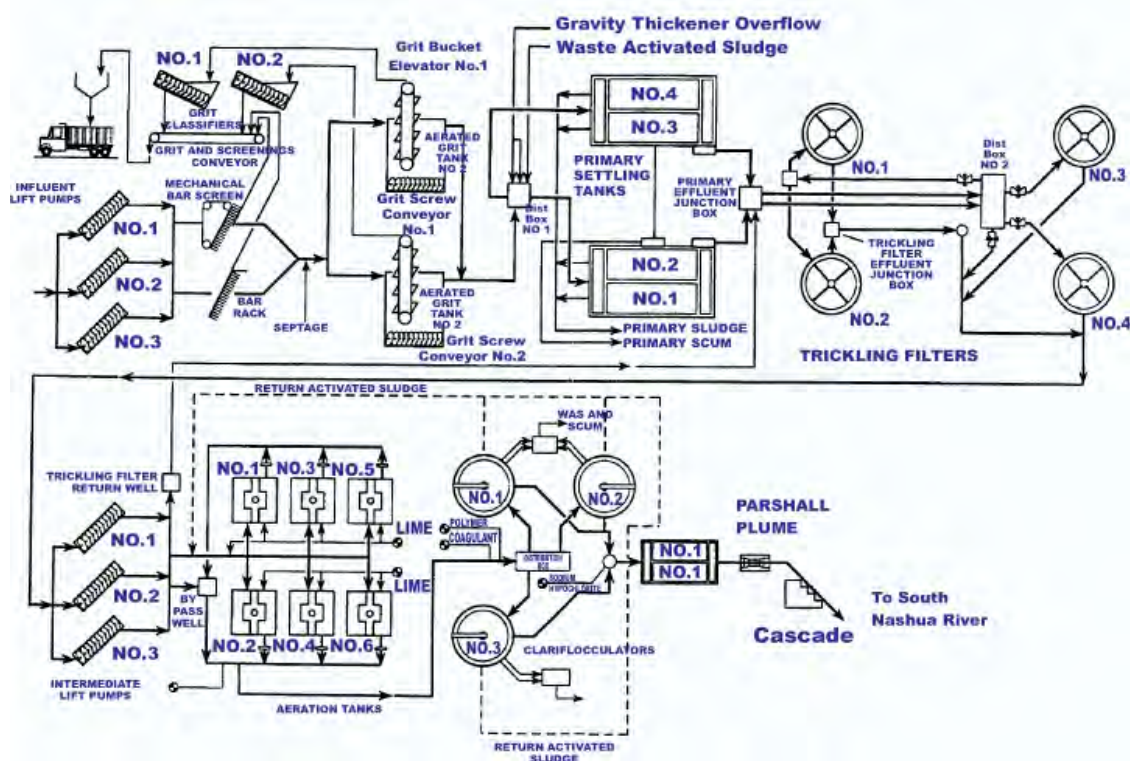

Preliminary Treatment and Metering: Wastewater enters the plant through two connections: (1) a 24-inch diameter reinforced concrete sewer connected to the MWRA 30-inch diameter interceptor on High Street (Clinton influent), and (2) an 18-inch diameter reinforced concrete sewer connected to the Lancaster interceptor on High Street (Lancaster Sewer District influent). Flow passes through two separate metering stations (one for Clinton and one for Lancaster flows), then, three influent pumps lift flow to a mechanical bar screen. A manual bar rack is located in parallel for use when the mechanical bar screen is out of service. Flow is then conveyed to two parallel aerated grit chambers where grit is removed using screw grit collectors. Under normal and peak flow conditions, the equipment works well and there are no performance problems. In extreme peak flow conditions, the influent flow can exceed the capacity of the existing influent pumps. A project completed in FY13 added four permanent submersible auxiliary pumps to provide redundancy for influent (two pumps) and intermediate (two pumps) pumping. The addition of the submersible pumps was a component of a larger project that also improved aeration efficiency. A \$4.069 million Clinton Facilities Rehabilitation project is programmed in the FY14 CIP. This project includes the rehabilitation or replacement of grit removal facilities with updated equipment during FY18-23. Staff also recommend a future \$1.5 million CIP project for replacement of three influent and three intermediate lift pumps in FY19-23.



Primary Treatment: Primary settling is accomplished in two rectangular tanks, each measuring 82-feet long by 24-feet wide by 9-feet deep. Chain and flight collectors are used for scum and primary sludge that is pumped to residuals processing. Under normal and peak flow conditions, the equipment works well and there are no performance problems. Staff recommend a new \$2.0 million CIP project for primary treatment upgrades and additional concrete repairs in the FY19-23.

Secondary Treatment: From the primary settling tanks, wastewater flows by gravity to four high-rate trickling filters. Two trickling filters are 60-foot diameter (upgraded from original plant) and two are 80-foot diameter (constructed in 1992). Five feet of crushed stone media is used in each tank. Three intermediate pumps lift wastewater from the trickling filters to six 318,000 gallon aeration (activated sludge) tanks (each is 50 by 50 by 17-feet). From the aeration tanks, wastewater is conveyed to three 80.25-foot diameter clariflocculators. Nitrogen removal takes place in the activated sludge process. Nitrification is accomplished by a biological process, which utilizes nitrogen as an energy source. Proper conditions must be maintained, such as dissolved oxygen supply and pH control, to promote microorganism growth in the aeration tanks. In 2008, the soda ash (sodium carbonate) addition system in the aeration process was replaced at a cost of \$267,000. A project completed in FY13 at \$2.06 million provides aeration efficiency improvements through installation of a fine bubble diffuser system in three of the six secondary aeration tanks to obtain a better oxygen transfer rate while reducing power consumption. Phosphorous removal is accomplished by the addition of ferric chloride in the return line of the aeration tanks. The ferric chloride precipitates phosphate at the final clarifiers (clariflocculators), settling it out with the sludge. A project programmed in the FY14 CIP at \$6.658 million will upgrade phosphorous removal process equipment over a 4-year period (FY14-17) to meet the more stringent NPDES permit limits under the next permit. Under normal and peak flow conditions, most of the secondary treatment equipment works well and there are no performance problems. For future asset replacement, staff recommend a \$1.0 million CIP project to add a fourth clariflocculator tank in the FY19-23 timeframe.



Disinfection/Dechlorination and Effluent Discharge: Disinfection occurs in two hypochlorite contact tanks, each measuring 100-feet long by 6-feet wide by 14-feet deep. Dechlorination takes place at the overflow cascade of the chlorine contact chamber. Sodium bisulfite is sprayed by injectors into the effluent stream to remove chlorine residual before going to the receiving water. The effluent is discharged through a parshall flume and a multistep cascade to the South Branch of the Nashua River via a 24-inch outfall. Under normal and peak flow conditions, the equipment works well and there are no performance problems. In the FY24-33 timeframe, staff recommend a CIP project to add an ultraviolet (UV) disinfection system at an estimated cost of \$3 million.

Residuals Process and Sludge Landfill: Primary and secondary sludge is pumped to two 50-foot diameter gravity sludge thickeners. The residuals are then transferred to two 40-foot diameter anaerobic sludge digesters. The digesters are operated in series. The primary tank has a fixed cover, while the secondary tank has a floating gas holding cover. Digested sludge is transferred to a 60-foot diameter sludge holding tank before the dewatering process that uses two belt filter presses.



Belt Filter Press

Dewatered sludge is trucked to

an MWRA-owned and operated residuals landfill located in Clinton. The double-lined sludge landfill includes a leachate collection system that pumps to the Clinton sewer system. The residuals process equipment works well and there are no performance problems. A 3-year project programmed in the FY14 CIP at \$3.111 million will clean and rehabilitate both sludge digesters during the FY14-16 timeframe (this project also includes plant-

wide concrete repairs). A \$4.069 million Clinton Facilities Rehabilitation project is programmed in the FY14 CIP. This project includes the replacement of two belt filter presses with updated equipment and closure of Clinton landfill cell #1 during FY18-23. Staff recommend an additional \$1.0 million residuals project be considered in future CIPs in the FY24-33 timeframe to add a fourth cell to the Clinton residuals landfill.



Digesters

Utilities and Plant Components: The primary electric feed to the Clinton AWWTP is from local commercial service. After a catastrophic loss of power in 2005 when a truck struck a utility pole just outside the plant, a project to install a 350 kW permanent diesel standby generator to provide backup electrical power to the secondary treatment portion of the Clinton AWWTP was completed in 2007 at a cost of \$230,000.

An existing project programmed in the FY14 CIP as part of the \$3.111 million sludge digester cleaning/rehabilitation project will make plant-wide concrete repairs. The concrete walls, walkways and structural support beams (primary clarifiers and secondary trickling filters) are significantly deteriorated with rebar exposure in some areas. This project involves repairing/replacing concrete, as needed. A roof rehabilitation project for a variety of buildings (administration, chemical, headworks, dewatering, and maintenance shop) is programmed in the FY14 CIP at a cost of \$509,000 during FY15-16. Four additional projects recommended for consideration in future CIPs to maintain operability of



Process Water System

additional plant components include: (1) replace/rehabilitation four process water pumps at an estimated cost of \$175,000 (FY14-18 timeframe); (2) upgrade security at the Clinton AWWTP and Clinton sludge landfill at an estimated cost of \$100,000 (FY14-18 timeframe); (3) primary treatment upgrades and additional concrete repairs at an estimated cost of \$2.0 million (FY19-23 timeframe); and (4) repair/seal the Clinton AWWTP roadway at an estimated cost of \$100,000 (FY19-23 timeframe).

14.08 Summary of Existing and Recommended Capital Projects

All Master Plan projects related to the Clinton AWWTP are summarized in this Section. Table 14-3 lists each project, its priority ranking, and the proposed expenditure schedule. A description and needs justification for each project is listed in bullet format below.

Projects in the Existing FY14 CIP: There are four projects for the Clinton AWWTP programmed in the FY14 CIP. The projects are described below and summarized in Table 14-3 (see line numbers 14.01 through 14.04).

- Phosphorous removal (design and construction) is programmed in the FY14 CIP at \$6.658 million. This 4-year project is scheduled for FY14-17 and will upgrade phosphorous removal process equipment to meet a more stringent NPDES permit limit (0.15mg/l). MWRA requested a 4-year compliance schedule for this upgrade. The phosphorous removal process will be sized for maximum daily flow conditions and will improve effluent discharge quality for the Clinton AWWTP.
- Sludge digester cleaning and rehabilitation and plant-wide concrete repairs are programmed in the FY14 CIP at \$3.111 million. This is a 3-year project is scheduled for FY14-16. The concrete repairs are needed for concrete walls, walkways and structural support beams (primary clarifiers and secondary trickling filters) that are significantly deteriorated with rebar exposure in some areas.
- A \$4.069 million Clinton Facilities Rehabilitation project is programmed in the FY14 CIP. This project includes the rehabilitation or replacement of grit removal facilities with updated equipment, replacement of two belt filter presses with updated equipment, and closure of Clinton landfill cell #1 during FY18-23.
- A roof rehabilitation project for a variety of buildings (administration, chemical, headworks, dewatering, and maintenance shop) is programmed in the FY14 CIP at a cost of \$509,000 during FY15-16.

Projects Recommended for Consideration in Future CIPs: There are ten new projects for the Clinton AWWTP recommended for consideration in future CIPs. The projects are described below and summarized in Table 14-3 (see line numbers 14.05 through 14.14).

- A long-term asset protection project is recommended at \$100,000 per year for the 10 year period FY14-23 and expanding to \$300,000 per year for the next 30 year period (FY24-53, the remainder of the 40 year Master Plan schedule). This project will provide annual baseline target expenditures for asset protection to fund smaller scale Clinton projects

that, individually, may not be seen as high priority. Future projects to be funded under this budget are anticipated to be similar to many of the relatively small projects recommended for FY14-18.

- Replacement or rehabilitation of the four process water pumps is recommended at an estimated cost of \$175,000 during FY14-18. Due to the relatively low cost of this project, it may be a candidate for CEB funding.
- Upgrade security at the Clinton AWWTP and Clinton residuals landfill including automatic fencing, identification card building access, identification card gate access, etc is recommended at an estimated cost of \$100,000 during FY14-18. Due to the relatively low cost of this project, it may be a candidate for CEB funding.
- Replacement of three influent and three intermediate lift pumps is recommended due to wear on the internal pump vanes causing reduced pumping efficiency. The project may include replacement or rehabilitation of pump cover plates and automatic oil injection system at an estimated cost of \$1.5 million during FY19-23.
- Primary treatment upgrade and additional concrete repairs are recommended at an estimated cost of \$2.0 million during FY19-23.
- Upgrade technology to meet future regulatory requirements and/or upgrade equipment based on new technologies/optimization is recommended as a place holder for future spending during the 40 year Master Plan period. Estimated costs are \$2.0 million each for FY19-23 and FY24-33, and an additional \$4.0 million for FY34-53.
- Addition of a fourth tank to the secondary clariflocculator is recommended at an estimated cost of \$1.0 million during FY19-23.
- Repair/sealing of the Clinton AWWTP roadway is recommended at an estimated cost of \$100,000 during FY19-23. Due to the relatively low cost of this project, it may be a candidate for CEB funding.
- Addition of an ultraviolet (UV) disinfection system to the Clinton AWWTP is recommended at an estimated cost of \$3.0 million during FY24-33.
- Expansion of the Clinton residuals landfill to add a fourth cell is recommended at an estimated cost of \$1.0 million during FY24-33.

**Table 14-3
Wastewater Master Plan - Clinton Advanced Wastewater Treatment Plant
Existing and Recommended Projects**

Line No	Priority	Project	Project Type	FY14 CIP Project No.	FY14 CIP Contract No.	Project Duration	Cost (\$1000)	Schedule	FY14 CIP Notes				Total Cost (\$1000)	
									5 years	10 years	15 years	20 years		
CLINTON WASTEWATER TREATMENT PLANT														
14.01	2	Clinton Phosphorous Removal - Design and Construction.	NF	210	19400_7411 19950_7377	4 years	6,658	FY14-17	6,658				6,658	
14.02	2	Clinton Sludge Digester Cleaning & Rehabilitation and Plant Wide Concrete Repairs	AP	210	19341_7277	3 years	3,111	FY14-16	3,111				3,111	
14.03	3	Clinton Facilities Rehabilitation for Grit Removal Facilities, 2 Belt Filter Presses, and Closure of Landfill Cell #1	AP	210	19406_7451	6 years	4,069	FY18-23	475	3,594			4,069	
14.04	3	Clinton Roofing Rehabilitation	AP	210	19405_7450	2 years	509	FY15-16	509				509	
							14,347	10,753	3,594					14,347
14.05	3	Clinton Long-term Asset Protection @ \$100k/yr for FY14-23 & \$300k/yr for FY24-53	AP	new		annual	10,000	FY14-53	500	500	3,000	6,000	10,000	
14.06	3	Clinton Process Water Pumps (4) System Replacement/Rehabilitation	AP	new		2 years	175	FY14-18	175				175	
14.07	4	Clinton Security Upgrades for Plant/Landfill	NF	new		2 years	100	FY14-18	100				100	
14.08	3	Clinton Influent (3) and Intermediate (3) Lift Pump Replacement	AP	new		5 years	1,500	FY19-23		1,500			1,500	
14.09	3	Clinton Primary Treatment Upgrade and Additional Concrete Repairs	AP	new		5 years	2,000	FY19-23		2,000			2,000	
14.10	3	Clinton Technology Upgrades to Meet Future Regulatory Requirements	NF	new		NA	8,000	FY19-53		2,000	2,000	4,000	8,000	
14.11	4	Clinton Secondary Clariflocculator - Fourth Tank	NF	new		5 years	1,000	FY19-23		1,000			1,000	
14.12	4	Clinton Repair/Sealing of Plant Roadway	AP	new		1 year	100	FY19-23		100			100	
14.13	4	Clinton UV Disinfection System	NF	new		5 years	3,000	FY24-33			3,000		3,000	
14.14	4	Clinton Landfill Expansion - Fourth Cell	NF	new		5 years	1,000	FY24-33			1,000		1,000	
SUBTOTAL - Recommended - Clinton							26,875	775	7,100	9,000	10,000	10,000	26,875	
SUBTOTAL - Existing and Recommended - Clinton							41,222	11,528	10,694	9,000	10,000	10,000	41,222	

CHAPTER 15

MWRA FINANCIAL ASSISTANCE FOR COMMUNITY-OWNED COLLECTION SYSTEMS

15.01 Chapter Summary

MWRA has 43 customer sewer communities within the regional wastewater collection system. Member community-owned sewer systems discharge wastewater to the MWRA interceptor system at more than 1800 connection points. Wastewater discharged by member communities is strongly influenced by seasonal and wet weather conditions. About half of the annual flow treated at Deer Island Treatment Plant (DITP) is sanitary flow with the remaining flow being groundwater infiltration and stormwater inflow (I/I) that enters the separated sewer system, as well as stormwater from combined sewers. High levels of I/I (as well as stormwater from combined sewers) consume capacity in the collection system that would otherwise be available to transport sanitary flow. During periods of high groundwater and extreme storm events, I/I entering the collection system may cause sewer surcharging, wastewater backups into buildings, and sanitary sewer overflows (SSOs), as well as increased operating costs.

Not only are the sewer systems of MWRA and its member communities physically connected, they also share a financial bond in that MWRA directly passes on the cost of operating the wastewater collection and treatment systems to its member cities and towns. Because of these relationships, it is important that MWRA work closely with local community officials, superintendents, and public works staff. The MWRA Advisory Board plays a pivotal role in ensuring that two way communication and coordination between MWRA and its member communities is in place. Financial assistance programs administered by MWRA for its member communities have been shaped by Advisory Board recommendations.

In this Chapter, MWRA's financial assistance program for rehabilitation of locally-owned collection systems is detailed. The I/I Local Financial Assistance Program is a critical component of MWRA's Regional I/I Reduction Plan. Local sewer system rehabilitation projects funded under the program are intended to at least offset ongoing collection system deterioration to prevent a net increase in regional I/I. Routine annual maintenance and periodic system rehabilitation/replacement are key elements to minimize the risk of sewer blockages or structural failure within community-owned collection systems. Key decision making to minimize risks includes where/how often to perform preventative maintenance activities and the cost/benefit analysis of when to rehabilitate aging sewer pipelines. Through the I/I Local Financial Assistance Program, MWRA is assisting its member communities in operating and maintaining their local collection systems, leading to uninterrupted service in a safe, cost-effective, and environmentally sound manner.

Under MWRA's I/I Local Financial Assistance Program, \$84.0 million in funding for community-owned collection system rehabilitation projects is identified in the 40 year master plan timeframe (FY14-53). The existing I/I Local Financial Assistance Program (net revenue of \$6.0 million through Phase 8) is programmed in the FY14 CIP. For Master Planning purposes,

five additional (\$40 million each) I/I Local Financial Assistance Program phases (Phases 9-13) are recommended for consideration in future CIPs. Each of the Phase 9-13 future fundings are recommended at \$18.0 million in grants, \$22.0 million in interest-free loans, and \$22.0 million in community loan repayments (each Program Phase covers a 13 year period). The net capital cost of each recommended future funding Phase is \$18.0 million. The total cost for five additional funding Phases is \$90.0 million. The five additional funding phases are recommended to begin at five year intervals: FY19, FY24, FY29, FY34, and FY39. Prior to expansion of the Program, coordination with the MWRA Advisory Board will be required to develop a recommendation for Board of Directors consideration. As of September 2013, initial discussions for potentially accelerating the addition of I/I Local Financial Assistance funding into the FY15 CIP planning process had begun. The costs noted below represent the net cost of MWRA grants, loans, and loan repayments. Section 15.04 – MWRA I/I Local Financial Assistance Program provides details on grant and loan funding provided to member communities.

Near-term (FY14-18):

- \$2.0 million in net program cost is programmed in the FY14 CIP (FY14-18) for the I/I Local Financial Assistance Program (through Phase 8).

Mid-term (FY19-23):

- \$5.0 million in net program revenue is programmed in the FY14 CIP (FY19-23) for the I/I Local Financial Assistance Program (through Phase 8).
- \$10.0 million in additional net program cost is recommended for consideration in future CIPs for FY19-23 for proposed Phase 9 of the I/I Local Financial Assistance Program.

Long-term (FY24-33 and FY34-53):

- \$3.0 million in net program revenue is programmed in the FY14 CIP (FY24-33) for the I/I Local Financial Assistance Program loans (through Phase 8).
- \$80.0 million in additional net program cost is recommended for consideration in future CIPs for FY24-33 and FY34-53 for the I/I Local Financial Assistance Program (Phases 9 through 13).

15.02 Infiltration/Inflow Impact on the Regional Collection System

MWRA's regional interceptor system tributary to the DITP receives flow from 43 member sewer communities (locally-owned collection systems) covering an area of about 518 square miles. The regional system serves about 2.2 million people, including the City of Boston and surrounding metropolitan area. About 95 percent of the service area is sewered. Figure 15-1 shows the MWRA sewer service area and the wastewater collection system. All flow from the service area is tributary to MWRA's DITP. The regional collection system encompasses about 274 miles of MWRA-owned sewer pipelines, 5200 miles of publicly-owned community sewers, and 5000+ miles of private sewer service connections. Most of the service area (93 percent) is served by separate sanitary and storm drainage systems. However, portions of five communities (Boston, Brookline, Cambridge, Chelsea, and Somerville) utilize combined sewers that account for seven percent of the sewer service area.

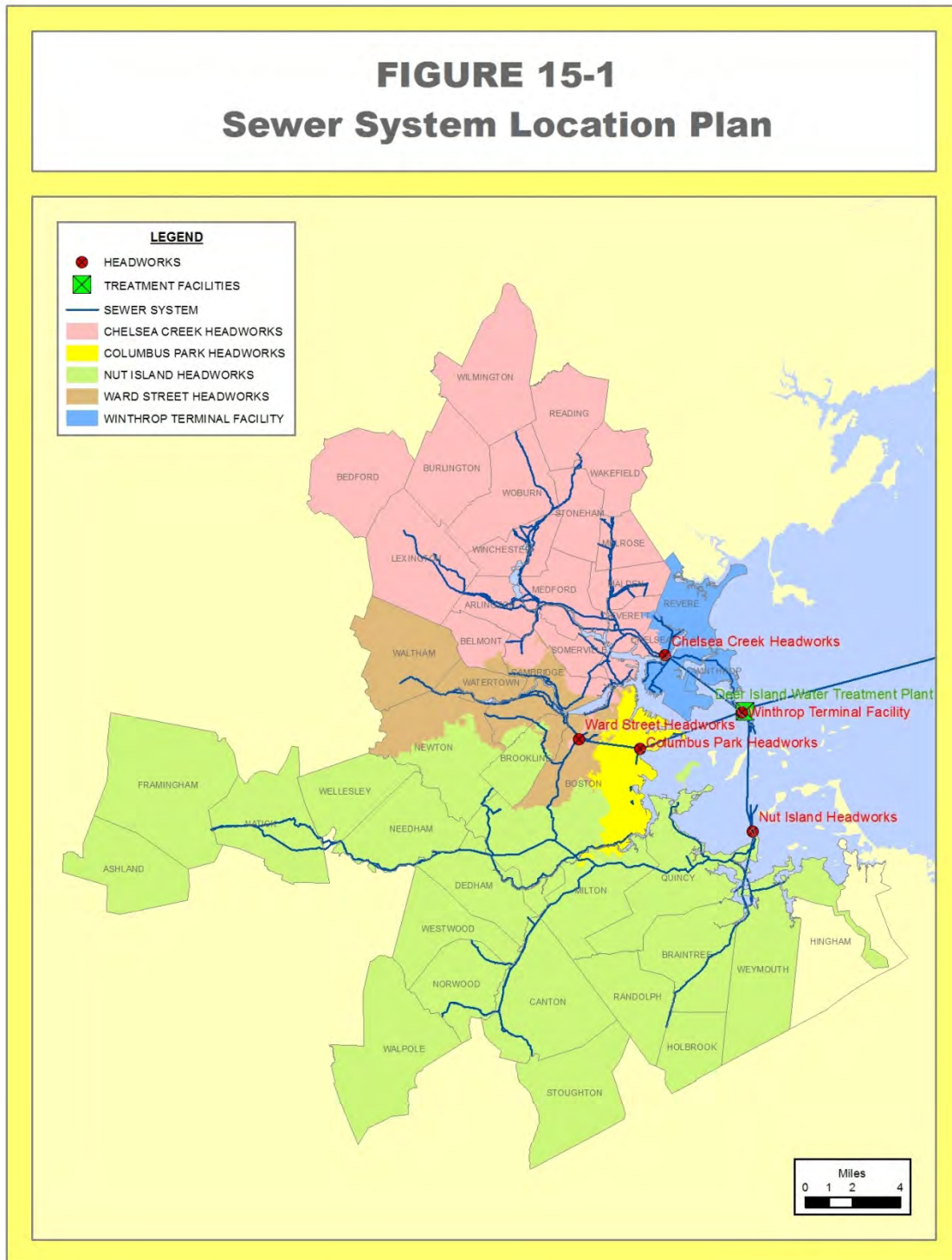

Community-owned sewer systems discharge wastewater to MWRA's interceptor system at more than 1800 connection points. Wastewater discharged by member communities to MWRA is strongly influenced by seasonal and wet weather conditions. The system average daily flow is approximately 360 mgd, minimum dry weather flow is approximately 260 mgd, and peak wet weather capacity to the DITP is 1,270 mgd, with additional system capacity available at combined sewer overflow (CSO) outfalls. The average annual wastewater flow contributed from the entire MWRA collection system varies, depending on annual precipitation, from about 330 to 430 mgd. About half of the annual flow treated at DITP is sanitary flow with the remaining flow being I/I (groundwater infiltration and stormwater inflow) entering the separated sewer system, as well as stormwater from combined sewers. I/I enters the sewer systems of both MWRA and its member communities through a variety of defects. High levels of I/I (as well as stormwater from combined sewers) consume capacity in the collection system that would otherwise be available to transport sanitary flow. During periods of high groundwater and extreme storm events, I/I entering the collection system may cause sewer surcharging, wastewater backups into buildings, SSOs, as well as increased operating costs.



Infiltration into a sanitary sewer

Infiltration and inflow are highest in the spring when: rainfall is high, the groundwater table is elevated, snowpack melts, soil is generally more saturated (a lower percentage of stormwater can infiltrate the ground), and evapotranspiration is low. Infiltration and inflow are lowest in the late summer when: rainfall is low, the groundwater table is low, soil is generally dry (a high percentage of stormwater can infiltrate the ground), and evapotranspiration is high. Infiltration tends to increase and decrease gradually over the course of the year. However, inflow can cause a rapid increase in wastewater flow during and after storm events leading to sewer system surcharging. The volume of infiltration and inflow that enters a collection system typically depends on a variety of factors, including: (1) type of sewer system defects; (2) magnitude and duration of storm events; (3) pre-storm (antecedent) conditions for sewer flow, groundwater elevation, flooding, snowmelt, and storm tide heights. Few problems exist within the regional sewer system during dry weather or as a result of small and medium storm events (those below the MassDEP designated 1.7 inch – six hour “design” storm level). Wastewater surcharging in sewers and the potential for backups into buildings and SSOs generally only occur during extreme storm events.



Sump pumps connected to building plumbing are sources of private inflow



Inflow into a sewer manhole located in a ponded wetland area

The Enabling Act (Chapter 372, Acts of 1984) establishes as a goal of MWRA the "reduction of infiltration and inflow for the service areas of the Authority...." The Enabling Act further provides that MWRA "shall also reasonably provide for abatement, reduction and prevention of infiltration and inflow of ground waters, surface waters or storm waters into the sewer system...."

Community wastewater discharges into the regional collection system are subject to MWRA's Sewer Use Regulations (360 CMR 10.000) which govern the discharge of sewage, drainage, substances, and wastes into any sewer under the control of MWRA, or into any sewer tributary thereto. MWRA's Sewer Use Regulations (online at: www.mwra.com) are intended to protect the public health, safety and welfare, and the environment, and ensure proper and safe operation of the Authority's wastewater treatment facilities by regulating the direct and indirect discharge of wastewater and pollutants to the MWRA's sewerage system. The Sewer Use Regulations include general requirements and specific prohibitions to minimize infiltration and inflow and regulate the quality of wastewater discharged into the regional collection system. Specifically, the Sewer Use Regulations require new sewer systems and existing system replacements or extensions be designed and built to minimize I/I "to the maximum extent possible." The Sewer Use Regulations also specifically prohibit the following discharges to the MWRA system: groundwater, storm water, surface waters, roof or surface runoff, tidewater, subsurface drainage (except as allowed by a construction site dewatering permit in a CSO area), non-contact cooling or industrial process waters, and uncontaminated contact cooling or industrial process waters.

15.03 MWRA Regional I/I Reduction Plan

The August 2000 NPDES Permit for DITP requires MWRA, in cooperation with its member communities, to eliminate excessive I/I to the MWRA sewer system. The Permit also requires MWRA to develop and implement a regional I/I reduction plan. The MWRA Board of Directors approved the Regional I/I Reduction Plan on May 23, 2001 and authorized staff to submit the Plan to EPA and MassDEP as required under MWRA's NPDES Permit. The Plan was submitted to EPA and MassDEP in June 2001. MassDEP approved the Plan in a letter dated November 19, 2002.

The Regional I/I Reduction Plan (dated September 2002) combines recommendations from the I/I Task Force Report (March 2001) with ongoing MWRA I/I reduction initiatives. The Plan replaced the Authority's 1990 I/I Reduction Policy. Implementation of the Regional I/I Reduction Plan focuses on the cooperative efforts of member communities, MassDEP, EPA and MWRA to develop and implement I/I reduction and sewer system rehabilitation projects. Under the Plan, MWRA has full legal and fiscal responsibility for implementation of operation, maintenance, and I/I reduction programs for the MWRA-owned interceptor system. Each member community retains full legal and fiscal responsibility for implementation of operation, maintenance, and I/I reduction programs for community-owned sewers. MWRA provides technical and financial assistance to member communities and works cooperatively with MassDEP, EPA, and other stakeholders to help solve local and regional sewer problems. MWRA's Regional I/I Reduction Plan is organized into five major goals:

1. MWRA will continue its current operation and maintenance program for the MWRA-owned interceptor system leading to the identification, prioritization and rehabilitation of structural and I/I problems.
2. MWRA will work cooperatively with member communities, MassDEP and EPA to eliminate sewer system backups into homes and other buildings and minimize health and environmental impacts of SSOs related to I/I.
3. MWRA will work cooperatively with member communities, MassDEP and EPA to reduce I/I in the regional collection system with emphasis on the following: (1) inflow reduction in areas tributary to sewer backups and SSOs, (2) private source inflow reduction, (3) infiltration that may impact groundwater or surface water resources, and (4) excessive infiltration as defined in MassDEP regulations or guidance documents.
4. MWRA will work cooperatively with member communities, MassDEP and EPA to expand existing efforts to educate and involve the public regarding regional sewer backups, SSOs and I/I reduction issues.
5. MWRA will provide technical assistance and work cooperatively with member communities, MassDEP and EPA regarding guidance on local operation and maintenance and capital improvement programs intended to provide a reasonable level of sewer service to local sewer users/ratepayers.

As required under the August 2000 NPDES Permit, MWRA submits an annual I/I report to EPA and MassDEP (prior to September 1 of each year). The MWRA's annual I/I reduction reports, as well as the Regional I/I Reduction Plan (September 2002) and I/I Task Force Report (March 2001) are online at: <http://www.mwra.com/comsupport/communitysupportmain.html>.

15.04 MWRA I/I Local Financial Assistance Program

The I/I Local Financial Assistance Program is a critical component of MWRA's Regional I/I Reduction Plan. Specifically, local sewer system rehabilitation projects are intended to at least offset ongoing collection system deterioration to prevent a net increase in regional I/I. In the

long-term, system rehabilitation should result in lower I/I, which will allow for future increases in sanitary (residential, commercial, industrial, and institutional) flow without a net increase in total wastewater flow. A second goal of the program is to assist member communities in implementing effective annual local collection system maintenance programs to ensure efficient operation in conjunction with ongoing repair/replacement of the collection system.

MWRA’s I/I Local Financial Assistance Program was initiated in May 1993 to provide funding for member sewer communities to perform I/I reduction and sewer system rehabilitation projects within their locally-owned collection systems. Following recommendations from the Advisory Board, the Board of Directors has approved a total program budget of \$300.75 million through FY13 (eight separate phases of funding). The funds have been allocated among the 43 MWRA sewer communities (see Table 15-1) based on their respective shares of overall MWRA wholesale sewer charges. Financial assistance for Program Phases 1 and 2 (total of \$63.75 million) was distributed for approved projects as a 25 percent grant and a 75 percent interest-free loan. The grant/loan split was revised for distribution of the Program Phases 3-8 funds (total of \$237 million) to a 45 percent grant and a 55 percent interest-free loan. All loans are repaid to MWRA over a five-year period beginning one year after the funds are distributed.

As of July 2013, \$248.5 million has been distributed to fund 444 local I/I reduction and sewer system rehabilitation projects. The projects generally take one to three years to complete. Distribution of the remaining \$52 million (through Phase 8) is approved through FY21 (repayments through FY26). The graph below presents grant and loan distributions and loan repayments (actual as of July 2013 and projected for future years).

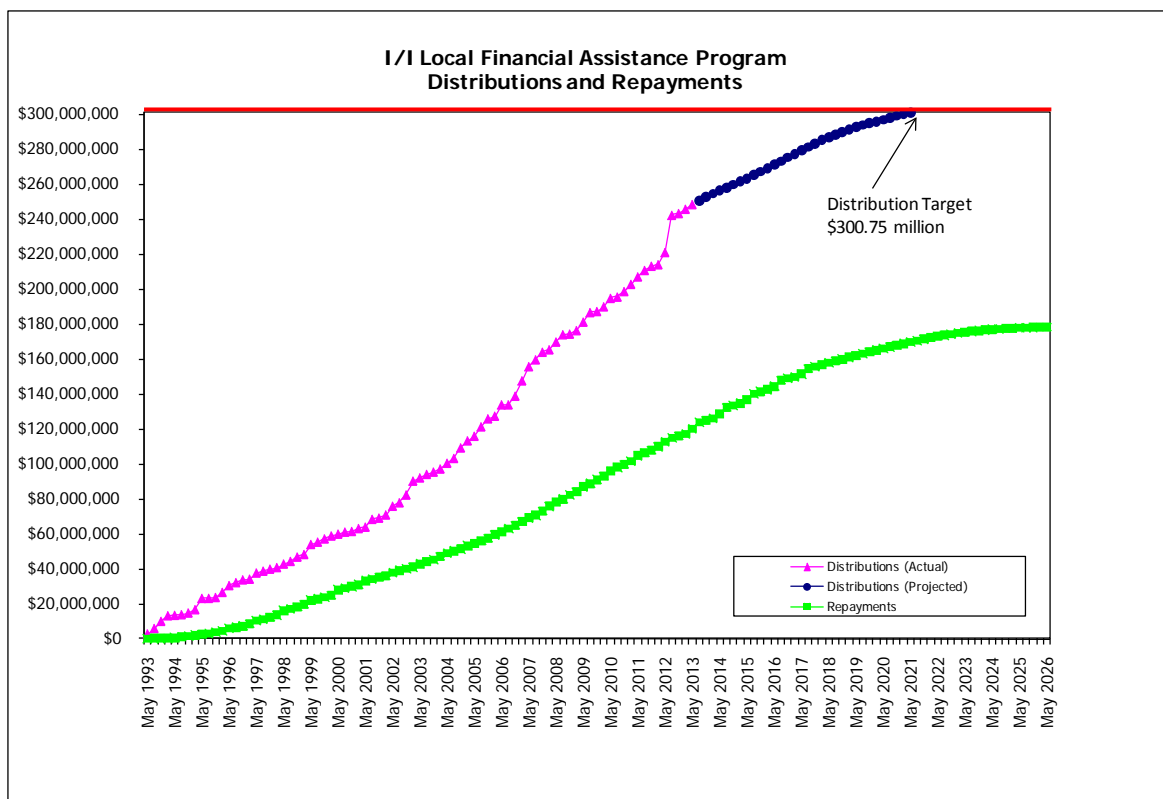

TABLE 15-1
MWRA I/I LOCAL FINANCIAL ASSISTANCE PROGRAM
FUNDING SUMMARY AS OF JULY 2013

Community	Total Allocations (Phases 1 - 8)	Total Distributions (Phases 1 - 8)	Percent Distributed	Funds Remaining
Arlington	\$5,613,000	\$5,613,000	100%	\$0
Ashland	\$1,328,500	\$930,500	70%	\$398,000
Bedford	\$2,282,600	\$1,691,600	74%	\$591,000
Belmont	\$3,439,100	\$2,992,100	87%	\$447,000
Boston	\$85,585,200	\$80,641,576	94%	\$4,943,624
Braintree	\$5,319,000	\$3,425,800	64%	\$1,893,200
Brookline	\$8,605,200	\$5,526,400	64%	\$3,078,800
Burlington	\$3,304,800	\$3,285,800	99%	\$19,000
Cambridge	\$15,566,100	\$11,077,055	71%	\$4,489,045
Canton	\$2,675,900	\$1,645,900	62%	\$1,030,000
Chelsea	\$4,232,100	\$3,605,100	85%	\$627,000
Dedham	\$3,914,000	\$3,914,000	100%	\$0
Everett	\$5,229,500	\$3,141,500	60%	\$2,088,000
Framingham	\$8,025,000	\$5,003,000	62%	\$3,022,000
Hingham	\$1,032,500	\$589,500	57%	\$443,000
Holbrook	\$1,059,600	\$896,562	85%	\$163,038
Lexington	\$4,835,300	\$4,159,300	86%	\$676,000
Malden	\$7,825,900	\$4,593,900	59%	\$3,232,000
Medford	\$7,961,600	\$4,794,600	60%	\$3,167,000
Melrose	\$3,914,300	\$2,845,300	73%	\$1,069,000
Milton	\$3,736,500	\$3,251,500	87%	\$485,000
Natick	\$3,644,600	\$2,270,600	62%	\$1,374,000
Needham	\$4,269,600	\$2,892,150	68%	\$1,377,450
Newton	\$13,861,400	\$11,565,400	83%	\$2,296,000
Norwood	\$4,519,400	\$3,955,399	88%	\$564,001
Quincy	\$12,882,000	\$11,125,000	86%	\$1,757,000
Randolph	\$3,894,800	\$2,810,900	72%	\$1,083,900
Reading	\$2,941,100	\$2,520,100	86%	\$421,000
Revere	\$6,424,900	\$5,502,900	86%	\$922,000
Somerville	\$10,117,800	\$8,662,790	86%	\$1,455,010
Stoneham	\$3,291,900	\$3,291,900	100%	\$0
Stoughton	\$3,126,900	\$2,696,900	86%	\$430,000
Wakefield	\$3,932,900	\$3,396,900	86%	\$536,000
Walpole	\$2,404,000	\$1,928,300	80%	\$475,700
Waltham	\$9,022,400	\$7,808,400	87%	\$1,214,000
Watertown	\$4,185,800	\$2,581,800	62%	\$1,604,000
Wellesley	\$3,769,700	\$2,748,808	73%	\$1,020,892
Westwood	\$1,650,300	\$1,425,300	86%	\$225,000
Weymouth	\$7,490,900	\$5,349,300	71%	\$2,141,600
Wilmington	\$1,606,000	\$1,388,000	86%	\$218,000
Winchester	\$2,777,000	\$1,848,300	67%	\$928,700
Winthrop	\$2,221,400	\$1,926,400	87%	\$295,000
Woburn	\$7,229,500	\$7,229,500	100%	\$0
Totals	\$300,750,000	\$248,549,040	83%	\$52,200,960

Details on the application process and program guidelines are provided on the Community Support Program web page: www.mwra.com/comsupport/communitysupportmain.html. Eligible projects focus on identifying, removing, and assuring elimination of I/I entering the regional collection system, as noted below:

- Construction or rehabilitation of sewer and/or storm drain systems;
- Construction or rehabilitation of service laterals or building plumbing;
- Pipeline and manhole lining, sealing, or spot repairs;
- Catch basin, area drain, downspout, or sump pump rerouting; and,
- Engineering planning, design and construction services associated with the above items.

Commitments to provide grants and interest-free loans for local I/I reduction projects are issued by MWRA in the form of financial assistance and loan agreements subject to the availability of Program funds. Financial assistance is distributed quarterly, on or about: February 15, May 15, August 15, and November 15. The financial assistance award is electronically transferred into a Massachusetts Municipal Depository Trust (MMDT) account established by the community. All financial assistance funds, together with the earned interest from the MMDT account, are required to be expended on approved community I/I reduction projects. Both the community and the MWRA receive monthly MMDT account statements to track account expenditures.

15.05 Summary of Existing and Recommended Capital Projects

All grant/loan distributions and loan repayments for Phases 1, 2, and 3 of the I/I Local Financial Assistance Program have been completed through FY13. Table 15-2 lists the net costs of I/I Local Financial Assistance Program Phases 4-8 that are programmed in the FY14 CIP, as well as, the additional net costs of proposed Phases 9-13 that are recommended for consideration in future CIPs. MWRA staff will continue to work cooperatively with the Advisory Board to identify potential program improvements which may be recommended to the Board for approval.

Projects in the FY14 CIP:

- The I/I Local Financial Assistance Program (through Phase 8) is programmed in the FY14 CIP at a net revenue of \$6.0 million in the FY14-26 timeframe. The net cost or revenue of the program includes the cost to provide grants and interest-free loans, as well as, the revenue from community loan repayments.

Projects Recommended for Consideration in future CIPs:

- For Master Planning purposes, five additional (\$40 million each) I/I Local Financial Assistance Program phases (Phases 9-13) are recommended for consideration in future CIPs. Each of the Phase 9-13 future fundings are recommended at \$18.0 million in grants, \$22.0 million in interest-free loans, and \$22.0 million in community loan repayments (each Program Phase covers a 13 year period). The net capital cost of each recommended future funding Phase is \$18.0 million. The total cost for five additional funding Phases is \$90.0 million. The five additional funding phases are recommended to begin at five year intervals: FY19, FY24, FY29, FY34, and FY39. Prior to expansion of the Program, coordination with the MWRA Advisory Board will be required to develop a recommendation for Board of Directors consideration. As of September 2013, initial discussions for potentially accelerating the addition of I/I Local Financial Assistance funding into the FY15 CIP planning process had begun.

Table 15-2
Wastewater Master Plan - Community-Owned Systems/Community Support
Existing and Recommended Projects

Last revision 8/6/13

Line No	Priority	Project	Project Type	FY14 CIP Project No.	FY14 CIP Contract No.	Project Duration	Cost (\$1000)	Schedule	FY14 CIP Notes					Total Cost (\$1000)
									5 years	5 years	5 years	10 years	20 years	
COMMUNITY-OWNED SYSTEMS/COMMUNITY SUPPORT - SEWER														
15.01	3	1/1 Financial Assistance (Phase 4-8 Net Cost)	AP	128	multi	13 years	(6,000)	ongoing-FY26	2,000	(5,000)	(3,000)			(6,000)
		Remaining Grant Portion (Phase 4-8)					23,800	ongoing-FY26	18,000	5,800				23,800
		Remaining Loan Portion (Phase 4-8)					29,200	ongoing-FY26	22,000	7,200				29,200
		Remaining Repayments (Phase 4-8)					(59,000)	ongoing-FY26	(38,000)	(18,000)	(3,000)			(59,000)
SUBTOTAL - Existing - Community Support									2,000	(5,000)	(3,000)	0	(6,000)	
COMMUNITY-OWNED SYSTEMS/COMMUNITY SUPPORT - WATER														
15.02	3	1/1 Financial Assistance (Phase 9 Net Cost) Beginning in FY19 \$18 mil.grants/\$22 mil	AP	new		13 years	18,000	FY19-31		10,000	8,000			18,000
15.03	3	1/1 Financial Assistance (Phase 10 Net Cost) Beginning in FY24 \$18 mil.grants/\$22 mil	AP	new		13 years	18,000	FY24-36			23,000	(5,000)		18,000
15.04	3	1/1 Financial Assistance (Phase 11 Net Cost) Beginning in FY29 \$18 mil.grants/\$22 mil	AP	new		13 years	18,000	FY29-41			10,000	8,000		18,000
15.05	3	1/1 Financial Assistance (Phase 12 Net Cost) Beginning in FY34 \$18 mil.grants/\$22 mil	AP	new		13 years	18,000	FY34-46				18,000		18,000
15.06	3	1/1 Financial Assistance (Phase 13 Net Cost) Beginning in FY39 \$18 mil.grants/\$22 mil	AP	new		13 years	18,000	FY39-51				18,000		18,000
SUBTOTAL - Recommended - Community Support									0	10,000	41,000	39,000	90,000	
SUBTOTAL - Existing and Recommended - Community Support									2,000	5,000	38,000	39,000	84,000	

CHAPTER 16

RUTLAND-HOLDEN SEWERS

16.01 Chapter Summary

The Rutland-Holden Sewers were constructed to help maintain and protect the purity of the water supplied from the Wachusett Reservoir, the Quinapoxet River (a tributary to Wachusett Reservoir), and the Ware River. The sewers convey wastewater from the service area in Rutland and Holden to the Upper Blackstone Treatment Plant located in Millbury. The Department of Conservation and Recreation (DCR) retains ownership of the Rutland-Holden Trunk Sewers and is responsible for entering into agreements with Worcester and the user communities for approving connections, and for any capital improvements. However, in Rutland, the Town Department of Public Works is the permitting authority for the Trunk Spur Sewers. By agreement with DCR, MWRA is responsible for operation and maintenance of the Rutland-Holden Trunk Sewers.

There are no existing or recommended MWRA capital projects associated with the Rutland-Holden Trunk Sewers proposed for consideration in a future CIP. All operation and maintenance costs associated with the Rutland-Holden Trunk Sewers are annual costs allocated within MWRA's Current Expense Budget. Should a capital project be required due to a situation such as a major failure, the DCR's Division of Water Supply Protection would have capital responsibility. However, since DCR's Division of Water Supply Protection is 100 percent funded by MWRA, it is likely MWRA would be involved in the capital project.

16.02 History of the Rutland-Holden Sewers

The Rutland-Holden Trunk Sewer was authorized under the Acts of 1932. The Metropolitan District Water Supply Commission¹ was authorized to construct, maintain, and operate one or more main sewers, with branch sewers, treatment works and other appurtenances as necessary or desirable, for the purpose of maintaining and protecting the purity of the water supplied from the Wachusett Reservoir, the Quinapoxet River (a tributary to Wachusett Reservoir), and the Ware River to the Metropolitan Water District and the City of Worcester. The Rutland-Holden Trunk Sewer became operational in 1934 and initially received wastewater flows from Rutland and Holden municipal sewers and the former Rutland State Hospital in Rutland, and conveyed the wastewater to the Worcester sewer system for treatment and disposal at the Upper Blackstone Treatment Plant. In 2003, West Boylston began to convey wastewater flows from newly completed sewers to the Rutland-Holden Trunk and Trunk Relief Sewers via a connection in Holden. When constructed, the trunk sewer was to be turned over to the MDC and maintained by it as part of the metropolitan water system.² Local public sewers and private connections

¹ The Metropolitan District Water Supply Commission was abolished and its powers and duties transferred to the Metropolitan District Commission (MDC) by Chapter 583 of the Acts of 1947. The MDC was abolished and its powers and duties transferred to the Department of Conservation and Recreation (DCR) in 2004.

² Legislation in 1939 authorized the MDC's predecessor to construct systems of sanitary sewers in Rutland and Holden to divert sewage from the watershed of Wachusett Reservoir, connecting with the Rutland-Holden Trunk Sewer. When constructed, these local sewers were turned over to the respective Towns and were thereafter to be maintained and operated by the Towns. The Towns were to annually reimburse the MDC "its proportionate share of the cost to the commission of receiving, caring for and disposing of said sewage," referencing the 1938 agreements.

from factories or institutions within Rutland and Holden could be connected to the trunk sewer under the control of the MDC with approval of the Department of Public Health. Towns, institutions and other persons connecting were to “pay a reasonable compensation” to the Commonwealth for use of the trunk sewer. Beginning in the 1970’s, capacity problems were experienced, leading to construction of the Rutland-Holden Relief Trunk Sewer in the 1980s. Construction was authorized under the Acts of 1979.

16.03 MWRA’s Role in the Rutland-Holden Sewers

MWRA’s Enabling Act (Chapter 372 of the Acts of 1984) granted MWRA the right to enter, use, improve, operate, maintain, and manage that portion of the system real property relating to the MDC’s sewer and water system infrastructure. However, there was not a clear distinction between the waterworks system (to be managed by MWRA) and the watershed system (to be managed by the MDC – now DCR). There was no mention of the Rutland-Holden Sewers in the MWRA Enabling Act. Since the sewers were constructed to protect the purity of the water supply and specifically to protect the Wachusett Reservoir and the Ware River (both listed as part of the watershed system), it would appear the sewers are part of the watershed system, not the waterworks system.

In order to clarify and resolve questions left unclear by the Enabling Act, MDC and MWRA entered into a Memorandum of Understanding (MOU) on April 6, 1986. This MOU set forth the mutual understanding of the joint and separate responsibilities of each agency. It provides that MDC (now DCR) retains ownership of the Rutland-Holden Trunk Sewers, and is responsible for entering into agreements with Worcester and the user communities for approving connections and for capital improvements, but MWRA agrees to operate and maintain the sewer lines. When the MDC was abolished, its former functions related to the Rutland-Holden Sewers transferred to the DCR Division of Water Supply Protection. MWRA and DCR entered into a successor MOU dated April 27, 2004 which continued the prior understanding of the joint and separate responsibilities of each agency relative to the Rutland-Holden Sewers.

16.04 Overview of the Rutland-Holden Sewers

Figures 16-1 and 16-2 show the Rutland and Holden community sewer systems and the Rutland-Holden Trunk and Relief Sewers (note that the two Figures connect). Rutland’s municipal sewer system discharges wastewater to the head of the Rutland-Holden Trunk and Trunk Relief Sewers (T/TRS). The T/TRS pass through a portion of Rutland, and essentially bisect Holden before discharging to the Worcester Interceptor. The Holden municipal sewer system discharges wastewater into the T/TRS via several connections along the developed segments of the T/TRS. The Worcester sewer system conveys wastewater to the Upper Blackstone Water Pollution Abatement District’s treatment plant in Millbury, MA. The treated effluent is discharged to the Blackstone River.

Rutland-Holden Trunk and Trunk Relief Sewers: The Rutland-Holden Trunk Sewer (completed in 1938) is 11 miles of 12-inch diameter cast iron pipe with 151 manholes. It begins at manhole 21 (the point at which the “C” and “F” lines discharge to it) and travels primarily cross-country to the Worcester City line. DCR owns the “C” line and the “F” line from manhole 7 to where it enters the relief sewer at manhole 21. The Rutland-Holden Trunk Relief Sewer (completed in 1984) is 8.3 miles of 16-inch and larger (as the pipe proceeds downstream) ductile iron pipe.

This sewer parallels the Trunk Sewer and there are numerous hydraulic relief connections between the two. Flow from West Boylston connects to the downstream end of the Rutland-Holden Trunk and Trunk Relief Sewers at manhole 123R in Holden, as shown on Figure 16-2.

Rutland Sewer System: The Rutland municipal sewer system consists of approximately 22 miles of Town-owned gravity collection sewers and approximately 470 manholes. The municipal sewers are constructed of primarily cast iron and some vitrified clay pipe ranging in size from 8 to 10-inches in diameter. In FY11, the average daily wastewater flow was 0.48 mgd. The Rutland municipal sewers discharge to the Rutland-Holden Trunk Sewer's "C" and "F" spur lines that are 8 and 10-inches in diameter and constructed of cast iron pipe. These spur lines discharge to the T/TRS. The system is owned and maintained by the Town of Rutland.

Holden Sewer System: The Holden municipal sewer system consists of approximately 25 miles of Town-owned gravity collection sewers averaging 8-inches in diameter, 16 miles of individual 6-inch service connections, plus approximately 40 miles of newer sewers, constructed in 1998 to 2003, under the then-MDC's Holden-West Boylston sewer project in the Wachusett Reservoir watershed. In FY11, the average daily wastewater flow was 1.56 mgd. These municipal sewers discharge to the Rutland-Holden Trunk and Trunk Relief Sewers in Holden. The system is owned and maintained by the Town of Holden.

Anna Maria College owns their own force main. It is operated and maintained by a contractor.

16.05 Flow Allocation, Sewer Billing, Operation, and Maintenance

As of 2012, there are four entities that discharge wastewater into the Rutland-Holden Sewer System and are charged for wastewater treatment and sewer system operations and maintenance: (1) Town of Rutland, (2) Town of Holden, (3) Town of West Boylston, and (4) Anna Maria College in Paxton which is connected by a cross-country force main.

Flow Allocation: The existing Sewer Use Agreements between DCR and the Towns, and DCR and Worcester (as amended) provide flow allocations for the system. The Rutland-Holden T/TRS are allocated 2.67 mgd annual average daily flow and 8.55 mgd peak flow for contribution into the Worcester Interceptor System. DCR has allocated the 2.67 mgd flow to the communities as follows: Rutland – 0.55 mgd; Holden – 1.53 mgd; and West Boylston – 0.59 mgd. The current physical capacity of the Rutland-Holden T/TRS is approximately 2.85 mgd annual average daily flow and 8.95 mgd peak flow. As of 2012, the Town of Rutland remains in a legal dispute with DCR over allocations.

Treatment Costs: The formula for wastewater treatment billing is administered by DCR. The formula is applied on a proportional basis depending on flows measured at monitoring stations, meters at West Boylston pump stations, and calculations performed by DCR. Using FY11 data as being generally representative of total wastewater flow transported through Worcester to the Upper Blackstone Treatment Plant, flows can be apportioned to the entities as follows: (1) Town of Rutland at 22.5 percent, (2) Town of Holden at 60.4 percent, (3) Town of West Boylston at approximately 16.2 percent, and (4) Anna Maria College at 0.9 percent. The DCR issues bills to the Towns (billing entities) which are to be made payable to the City of Worcester.

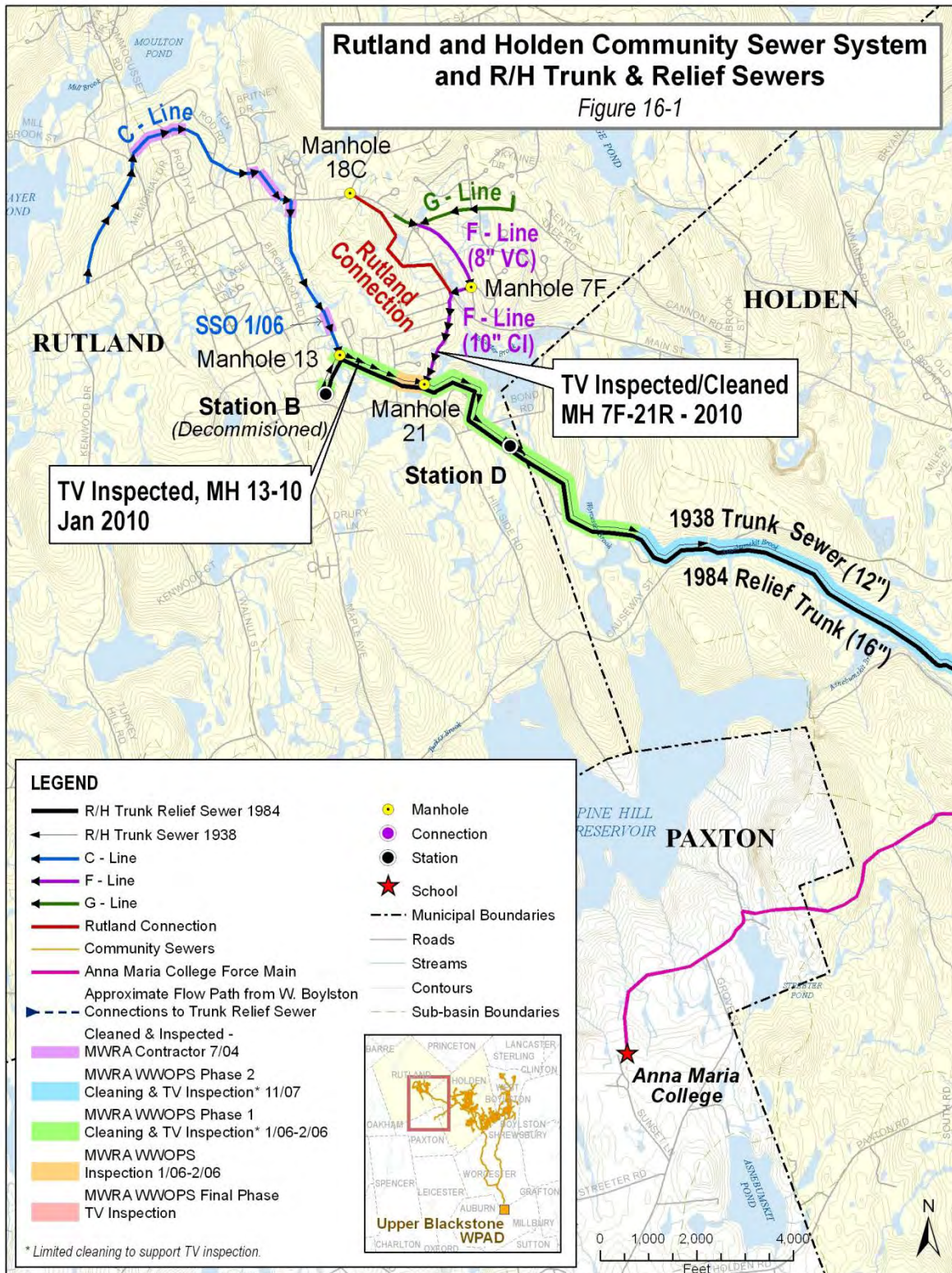

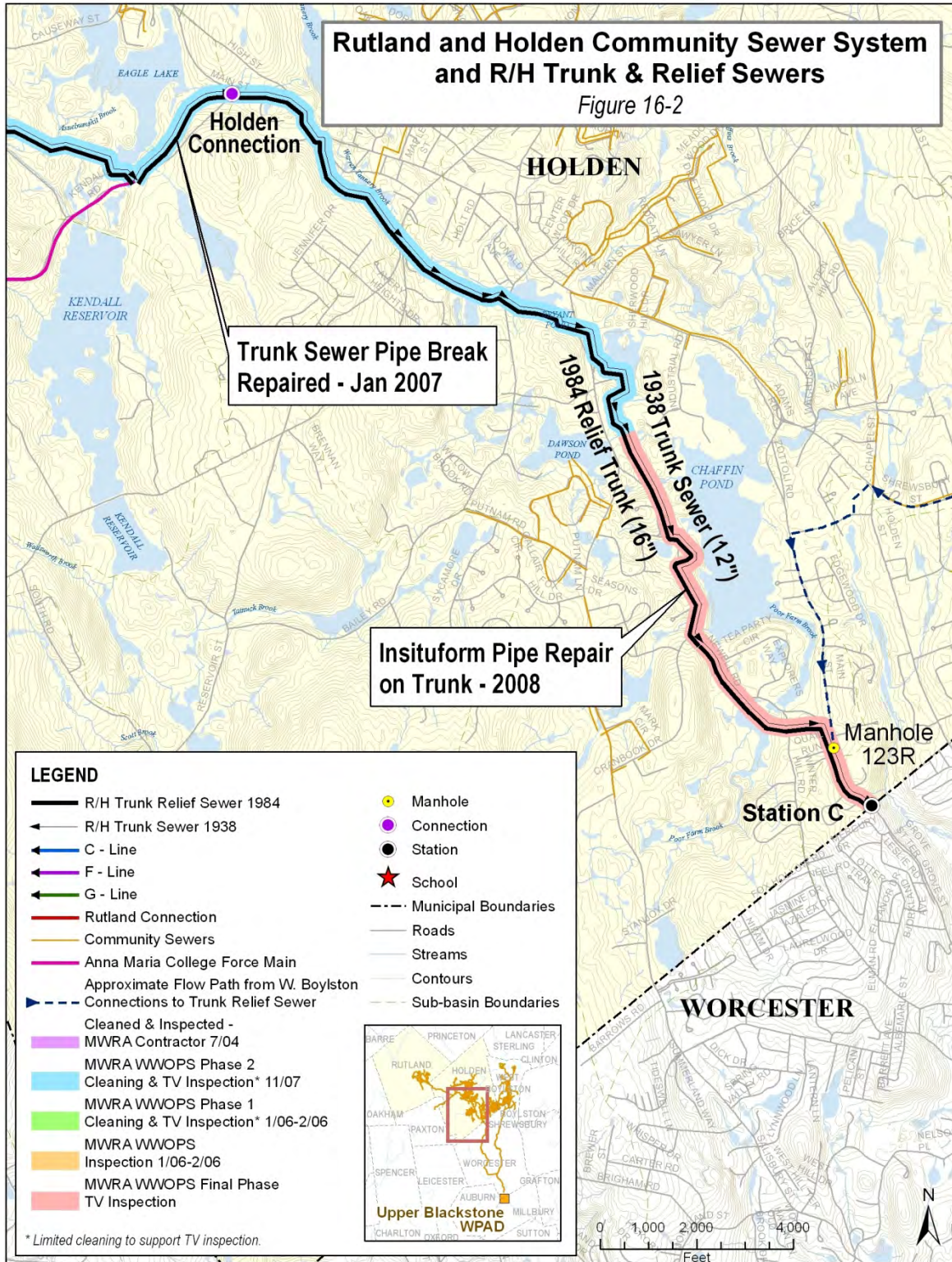

Operation and Maintenance Costs: Per the existing MOU, MWRA as requested by DCR, shall “operate and maintain the sewer lines, including meter readings, gates and valves, manhole inspections and evaluations of problem conditions such as infiltration and inflow and shall be reimbursed for its costs by Holden, West Boylston, and Rutland through established payment mechanisms. Operation, maintenance, and repair are defined as those items that can be charged to the users.” MWRA issues work orders routinely through its MAXIMO work order program.

This system tracks the cost associated with labor, equipment, and materials and applies an MWRA overhead rate. MWRA prepares the fiscal year operation and maintenance costs, including quarterly meter station calibration and electrical charges, after the fourth quarter and then apportions these charges to each Town (or billing entity) based upon metered flow for that fiscal year period. Western Operations submits these calculations and backup materials to the Finance Division which in turns issues the bills. The bills are made payable to MWRA.

16.06 Past Special Projects

Sewer Cleaning and TV Inspection: From 2005 - 2009, MWRA embarked on a special project utilizing MWRA Wastewater Field Operations staff to clean, televise and inspect the Rutland-Holden Trunk and Trunk Relief Sewers scheduled over a four-phase period. This special project was in addition to routine operation and maintenance performed by MWRA Western Operations staff. The Towns



were briefed on the proposed project and agreed with the billing scheme that spread the project cost over four years. No capital costs were included for this project.

Wastewater Metering Project: In 2006, MWRA performed sewer flow metering at specific locations to better understand wastewater flow contributions in the Rutland Trunk C spur sewer line. No capital costs were included for this project; the costs were included in MWRA’s FY07 Current Expense Budget.

Easement Project 2006: Over the last several decades, development has increased in the Rutland-Holden area. This has led to a number of encroachments by abutters along the sewer easement, particularly on the Rutland Trunk C spur sewer line. Easement encroachments include fences, trees, swimming pools, porches, and foundations. Encroachments cause grounds crews to make special arrangements for access, use alternative equipment, hand-cut when they should machine-cut, and generally make operation and maintenance work less efficient. Some encroachments may also cause structural problems to the sewer pipe. To address this encroachment problem, in 2006, MWRA completed a professional land retracement survey to properly demarcate the sewer and sewer easement along the Trunk Sewer in Rutland and in a specific section of Holden where there were several encroachments observed. The goal of this project was to keep the easement open for operation and maintenance operations. The strategy was to: (1) document legal

easements on current plot plans, (2) provide a copy of the survey to both Town officials and local builders to avoid future encroachments and, (3) provide a certified letter to property owners explaining the easement conditions, and any existing encroachments, with a copy of their plot plan identifying the encroachment and sewer easement. DCR personnel followed-up with the property owners identified with encroachments to ensure they were addressed. No capital costs were included for this project; the costs were included in MWRA's FY07 Current Expense Budget.

Trunk Sewer Repair 2007: As a result of the prior TV inspection work, a segment of cross-country Trunk Sewer off Kendall Road in Holden was found to have substantial spider cracks. MWRA performed in-house repairs on this segment of pipe.



Failed Trunk Sewer off Kendall Road



Excavation of Kendall Road Trunk Sewer

Trunk Sewer Repair 2009: As a result of the prior TV inspection work, a hole in the crown of the Trunk Sewer off Newell Road was discovered and repaired using cast-in-place-pipe lining by InsituForm.

F-Line Special Cleaning 2010: In December 2010, a specialty sewer cleaning contractor was procured to address a needed cleaning of the F-Line manhole 7F – 21R. There had been historic blockages and SSOs on this line and, due to its configuration, special cleaning equipment was needed.

C-Line Special TV inspection 2012: In advance of a planned residential development with a road over a segment of sewer with relatively shallow cover, the C-Line from manhole 10 to manhole 13 was jetted and TV-inspected in January 2012 to assess condition. In prior years, there was an SSO along this segment. The inspection identified, and subsequently removed, a long board from the pipe which may have caused an obstruction.

16.07 Summary of Existing and Recommended Capital Projects

There are no existing or recommended MWRA capital projects associated with the Rutland-Holden Trunk Sewers proposed for consideration in a future CIP. All operation and maintenance costs associated with the Rutland-Holden Trunk Sewers are annual costs allocated within MWRA's Current Expense Budget. Should a capital project be required due to a situation such



Rutland C-line vicinity of MH 8

as a major failure, the DCR's Division of Water Supply Protection would have capital responsibility. However, since DCR's Division of Water Supply Protection is 100 percent funded by MWRA, it is likely MWRA would be involved in the capital project.

From an O&M perspective, MWRA plans to begin another cycle of internal TV inspection of the Rutland-Holden Sewer system. This should be done periodically to ensure continued serviceability and to identify potential problems early.

A large maintenance project will be required to correct the remaining segment of Rutland 10-inch CI trunk sewer cross-country easement flooded by beaver activity.

Presently, O&M and inspection work is prevented due to flooded conditions. Beavers will have to be removed (with repeated inspections to ensure they do not return) and the easement brought back up to grade with fill to allow both routine maintenance and access to vactors and camera trucks for an internal inspection. This section covers MH 6A – MH 10. Some in-house work has addressed a portion of the flooded area but additional work is needed.



Trucks on C-line easement brought up to grade with fill